

STS2/PDU™

INSTALLATION, OPERATION & MAINTENANCE MANUAL



**250A - 800A
Three Phase
60 Hz**

CONTACTING LIEBERT FOR SUPPORT

To contact Liebert Global Services for information or repair service in the United States, call 1-800-LIEBERT (1-800-543-2378). Liebert Global Services offers a complete range of start-up services, repair services, preventive maintenance plans and service contracts.

For repair or maintenance service outside the 48 contiguous United States, contact Liebert Global Services, if available in your area. For areas not covered by Liebert Global Services, the authorized distributor is responsible for providing qualified, factory-authorized service.

For Liebert Global Services to assist you promptly, please have the following information available:

Part numbers: _____

Serial numbers: _____

Rating: _____

Date purchased: _____

Date installed: _____

Location: _____

Input voltage/frequency: _____

Output voltage/frequency: _____

TABLE OF CONTENTS

| | |
|--|---------------------------|
| CONTACTING LIEBERT FOR SUPPORT | INSIDE FRONT COVER |
| IMPORTANT SAFETY INSTRUCTIONS | 1 |
| 1.0 UNPACKING AND INSPECTIONS | 3 |
| 1.1 External Inspections | 3 |
| 1.2 Unloading and Handling | 3 |
| 1.2.1 Handling Considerations | 4 |
| 1.2.2 Unit Preparation | 4 |
| 1.3 Internal Inspections | 4 |
| 2.0 LOCATION CONSIDERATIONS | 5 |
| 2.1 Recommended Minimum Service Clearances | 5 |
| 2.2 Heat Output | 5 |
| 2.3 Operating Environment | 5 |
| 2.4 Altitude | 6 |
| 3.0 LOCATING THE STS2/PDU | 7 |
| 3.1 Anchoring the Unit to the Floor | 7 |
| 3.2 Leveling of the 250A Only STS2/PDU Without Anchoring | 7 |
| 4.0 POWER AND CONTROL WIRING | 8 |
| 4.1 Input and Output Power Connections | 8 |
| 4.2 System Grounding | 11 |
| 4.3 Control Wiring Connections | 11 |
| 4.4 Remote Source Selection Wiring | 11 |
| 4.5 Power Supply | 12 |
| 5.0 OUTPUT POWER WIRING | 13 |
| 5.1 Customer Connections | 13 |
| 6.0 OPTIONS | 14 |
| 6.1 Programmable Relay Board | 14 |
| 6.2 Input Contact Isolator Board | 14 |
| 6.3 Comms Board | 15 |
| 6.4 Internal Modem | 15 |
| 6.5 Network Interface Card (NIC) | 15 |
| 6.6 Remote Source Selection | 16 |
| 6.7 Key Lockout Switch | 16 |
| 6.8 Static Switch Redundant Output Breaker | 16 |
| 6.9 Inline Panelboards | 16 |
| 6.10 I-Line Panelboards | 16 |
| 6.11 Subfeed Breakers | 16 |
| 6.12 K-Factor Transformers | 16 |
| 6.13 Surge Suppression System | 16 |
| 7.0 INSTALLATION DRAWINGS | 17 |

| | | |
|-------------|---|-----------|
| 8.0 | INTRODUCTION TO STS2/PDU OPERATIONS | 69 |
| 8.1 | System Description | 69 |
| 8.1.1 | Redundancy | 69 |
| 8.1.2 | Reliability and Agency Requirements | 70 |
| 8.1.3 | Factory Backup and Service Assistance | 70 |
| 8.2 | Modes of Operation | 70 |
| 8.2.1 | Normal (Preferred Source) | 70 |
| 8.2.2 | Transfer | 71 |
| 8.2.3 | Transfer Inhibit | 71 |
| 8.2.4 | Bypass | 71 |
| 8.3 | Operator Controls | 71 |
| 9.0 | THEORY OF OPERATION | 72 |
| 9.1 | General Description | 72 |
| 9.1.1 | Static Transfer Switch 2 Power Distribution Unit | 72 |
| 9.1.2 | Source Transfer | 72 |
| 9.1.3 | Automatic Transfer/Retransfer | 72 |
| 9.1.4 | Emergency Transfer | 73 |
| 9.1.5 | Load Current Transfer Inhibit | 73 |
| 9.1.6 | SCR Failure | 73 |
| 9.1.7 | On/Off Sequence | 73 |
| 9.2 | Detailed Component Description | 73 |
| 9.2.1 | Controls | 73 |
| 9.2.2 | Circuit Breakers and Non-Automatic Circuit Breakers | 74 |
| 9.2.3 | SCRs | 74 |
| 9.2.4 | Logic Modules | 74 |
| 9.2.5 | Audible Alarm | 74 |
| 9.2.6 | RS-232 Port | 74 |
| 10.0 | OPERATING INSTRUCTIONS | 75 |
| 10.1 | Normal System Turn-On | 75 |
| 10.2 | Manual Transfer / Preferred Source Selection | 76 |
| 10.3 | Enabling Remote Source Selection | 77 |
| 10.4 | Maintenance Bypass | 78 |
| 10.4.1 | Bypass Procedures for Source 1 | 79 |
| 10.4.2 | Bypass Procedures for Source 2 | 80 |
| 10.5 | Normal System Shutdown | 80 |
| 10.5.1 | Shutdown in Static Transfer Switch Mode | 80 |
| 10.5.2 | Shutdown in Maintenance Bypass Mode | 81 |
| 11.0 | ALARMS AND FAULTS | 82 |
| 11.1 | Event Mask | 82 |
| 11.2 | Event and History Logs | 83 |
| 11.2.1 | Event Log | 83 |
| 11.2.2 | History Log | 84 |
| 11.3 | Alarm Notes | 84 |
| 11.4 | List of Messages | 84 |

| | | |
|-------------|---|-------------|
| 12.0 | COMMUNICATION INTERFACES | .87 |
| 12.1 | Using the RS-232 Port | 88 |
| 12.1.1 | Connecting and Using a Terminal | 88 |
| 12.1.2 | Configuring the STS2/PDU via the Terminal | 89 |
| 12.1.3 | Setting Bitpacked Options With the Terminal | 92 |
| 12.1.4 | Setting Event Masks with the Terminal | 94 |
| 13.0 | TOUCH SCREEN DISPLAY | .96 |
| 13.1 | Display Overview | 96 |
| 13.2 | Menu Overview | 97 |
| 13.2.1 | Security | 98 |
| 13.3 | Mimic Display | 99 |
| 13.4 | Event Controls | 99 |
| 13.5 | Event Display | 99 |
| 13.6 | Menu Bar | 99 |
| 13.7 | Configuration Menu | 99 |
| 13.7.1 | Logs | 113 |
| 13.7.2 | Source Transfers | 114 |
| 13.7.3 | Startup Procedure | 114 |
| 13.7.4 | Bypass Procedure | 114 |
| 13.7.5 | Help | 114 |
| 13.7.6 | Logo | 114 |
| 13.8 | Cleaning the LCD Touch Screen | 114 |
| 14.0 | SPECIFICATIONS | .115 |
| 14.1 | System Configuration | 115 |
| 14.1.1 | Frequency | 115 |
| 14.1.2 | Input Voltage | 115 |
| 14.1.3 | Output Voltage | 115 |
| 14.1.4 | System Current Ratings | 115 |
| 14.1.5 | Grounding | 115 |
| 14.1.6 | Electrical Requirements | 116 |
| 14.1.7 | Surge Suppression | 116 |
| 14.1.8 | Response Time | 116 |
| 14.1.9 | Environmental Requirements | 116 |
| 14.2 | System Components | 116 |
| 14.2.1 | Frame and Enclosure | 117 |
| 14.2.2 | Caster and Leveling - 250A only | 117 |
| 14.2.3 | Cooling | 117 |
| 14.2.4 | Access | 118 |
| 14.2.5 | Circuit Breakers | 118 |
| 14.2.6 | Cable Entrance | 118 |
| 14.2.7 | Doors | 118 |
| 14.2.8 | Color Graphical Display | 118 |
| 14.2.9 | RS-232 Port | 119 |
| 14.2.10 | Terminal Port Connections | 119 |
| 14.2.11 | RS-232 Interface Parameters | 120 |
| 14.2.12 | Maintenance Bypass | 120 |
| 14.2.13 | Fuseless Design | 120 |
| 14.2.14 | Options | 120 |

| | | |
|-------------|---|------------|
| 15.0 | EVENT MESSAGE HELP TEXT | 121 |
| 16.0 | MAINTENANCE | 144 |
| 16.1 | Proper Tightening of Nuts and Bolts | 144 |
| 16.2 | Testing the STS2/PDU | 144 |
| 16.3 | Changing the Air Filter | 144 |
| 17.0 | CUSTOMER SETTINGS. | 145 |
| 17.1 | Programmable Relay Board Settings | 145 |
| 17.2 | Input Contact Isolator Settings | 146 |

FIGURES

| | | |
|-----------|---|----|
| Figure 1 | Recommended derating for high altitude operation | 6 |
| Figure 2 | Maximum ambient temperature for full load operation at higher altitudes. | 6 |
| Figure 3 | Typical STS2/PDU, one-line diagram | 9 |
| Figure 4 | Typical STS2/PDU, one-line diagram, with dual static switch output circuit breakers (not available on 250A units) | 9 |
| Figure 5 | Typical STS2/PDU, one-line diagram, with inline distribution, dual static switch output circuit breakers10 | |
| Figure 6 | Typical STS2/PDU, one-line diagram, with I-Line distribution, dual static switch output circuit breakers | 10 |
| Figure 7 | Outline drawing, 250A STS2/PDU. | 17 |
| Figure 8 | Outline drawing, 250A STS2/PDU with right side I-Line distribution | 18 |
| Figure 9 | Outline drawing, 250A STS2/PDU with right side inline distribution | 19 |
| Figure 10 | Outline drawing, 250A STS2/PDU with left side I-Line distribution | 20 |
| Figure 11 | Outline drawing, 250A STS2/PDU with left side Inline distribution | 21 |
| Figure 12 | Outline drawing, 400-600A STS2/PDU with right side inline distribution | 22 |
| Figure 13 | Outline drawing, 400-600A STS2/PDU with right side output breaker or I-Line distribution | 23 |
| Figure 14 | Outline drawing, 400-600A STS2/PDU with left side inline distribution | 24 |
| Figure 15 | Outline drawing, 400-600A STS2/PDU with left side output breaker or I-Line distribution | 25 |
| Figure 16 | Outline drawing, 800A STS2/PDU with right side output breaker or I-Line distribution. | 26 |
| Figure 17 | Outline drawing, 800A STS2/PDU with right side inline distribution | 27 |
| Figure 18 | Outline drawing, 800A STS2/PDU with left side output breaker or I-Line distribution | 28 |
| Figure 19 | Outline drawing, 800A STS2/PDU with left side inline distribution. | 29 |
| Figure 20 | Outline drawing, 250A STS2/PDU with key lockout switch option | 30 |
| Figure 21 | Outline drawing, 400-600A STS2/PDU, inline distribution, right side with key lockout switch option | 31 |
| Figure 22 | Outline drawing, 800A STS2/PDU, inline distribution, right side with key lockout switch option | 32 |
| Figure 23 | Electrical field connections, 250A STS2/PDU input/output with CB8. | 33 |
| Figure 24 | Electrical field connections, 250A STS2/PDU input with CB3. | 34 |
| Figure 25 | Electrical field connections, 250A STS2/PDU input with CB3 & CB3A | 35 |
| Figure 26 | Electrical field connections, 400-600A STS2/PDU input with CB3 | 36 |
| Figure 27 | Electrical field connections, 400-600A STS2/PDU input with CB3 and CB3A | 37 |
| Figure 28 | Electrical field connections, 800A STS2/PDU input with CB3. | 38 |
| Figure 29 | Electrical field connections, 800A STS2/PDU input with CB3 and CB3A. | 39 |
| Figure 30 | Electrical field connections, 250A STS2/PDU output with inline panelboards. | 40 |
| Figure 31 | Electrical field connections, 400-800A STS2/PDU output with inline panelboards | 41 |
| Figure 32 | Electrical field connections, STS2/PDU output with I-Line panelboard | 42 |
| Figure 33 | Electrical field connections, 400-600A STS2/PDU with right side output breaker. | 43 |
| Figure 34 | Electrical field connections, 400-600A STS2/PDU with left side output breaker | 44 |
| Figure 35 | Electrical field connections, 800A STS2/PDU with right side output breaker | 45 |

| | | |
|-----------|---|-----|
| Figure 36 | Electrical field connections, 8600A STS2/PDU with left side output breaker. | 46 |
| Figure 37 | Electrical field connections, 800A STS2/PDU interconnect wiring | 47 |
| Figure 38 | Electrical field connections, 800A STS2/PDU interconnect wiring, breaker section | 48 |
| Figure 39 | Electrical field connections, 800A STS2/PDU interconnect wiring, STS section | 49 |
| Figure 40 | Electrical field connections, 800A STS2/PDU interconnect wiring, left side distribution cabinet | 50 |
| Figure 41 | Electrical field connections, 800A STS2/PDU interconnect wiring, left side one-line | 51 |
| Figure 42 | Electrical field connections, 800A STS2/PDU interconnect wiring, left side one line with CB3A | 52 |
| Figure 43 | Electrical field connections, 800A STS2/PDU interconnect wiring, right side one line | 53 |
| Figure 44 | Electrical field connections, 800A STS2/PDU interconnect wiring, right side one line with CB3A | 54 |
| Figure 45 | Control wiring, 800A STS2/PDU, left side distribution | 55 |
| Figure 46 | Control wiring, 800A STS2/PDU, right side distribution | 56 |
| Figure 47 | Control connection location, 250A STS2/PDU | 57 |
| Figure 48 | Control connection location, 400-800A STS2/PDU | 58 |
| Figure 49 | Control location drawing conduit box, top entry, 400-600A STS2/PDU | 59 |
| Figure 50 | Control wiring for the programmable relay board option. | 60 |
| Figure 51 | Control wiring for the input contact isolator board option. | 61 |
| Figure 52 | Control wiring for comms board. | 62 |
| Figure 53 | Control wiring for the internal modem option | 63 |
| Figure 54 | Control wiring for the Network Interface Card (NIC) option. | 64 |
| Figure 55 | Control wiring for the RS-232 Port | 65 |
| Figure 56 | Control wiring for remote source selection option. | 66 |
| Figure 57 | Color LCD touch screen display | 67 |
| Figure 58 | STS2/PDU touch screen display. | 71 |
| Figure 59 | STS2/PDU touch screen display. | 75 |
| Figure 60 | Source Transfer screen | 77 |
| Figure 61 | Gate board viewing slot locations. | 78 |
| Figure 62 | STS2/PDU Touch Screen Display | 96 |
| Figure 63 | Menus | 97 |
| Figure 64 | Keyboard and keypad displays. | 97 |
| Figure 65 | Key lockout switch | 98 |
| Figure 66 | Event Mask dialog box | 100 |
| Figure 67 | User settings dialog box | 101 |
| Figure 68 | Source setpoints | 102 |
| Figure 69 | PDU setpoints | 104 |
| Figure 70 | Comm options dialog box | 105 |
| Figure 71 | Modem dialog box | 106 |
| Figure 72 | Input Contact Isolator dialog box. | 108 |
| Figure 73 | Programmable relay board dialog box | 110 |
| Figure 74 | System options | 111 |
| Figure 75 | PDU options button | 112 |
| Figure 76 | Event log | 113 |
| Figure 77 | History log | 113 |

TABLES

| | | |
|----------|--|-----|
| Table 1 | Shipping weights (typical) | 4 |
| Table 2 | Heat output | 5 |
| Table 3 | Altitude conversion—feet to meters. | 6 |
| Table 4 | Input/output conduit plate specifications | 10 |
| Table 5 | Remote source selection terminal block. | 11 |
| Table 6 | Terminal block 1 and terminal block 2 wire connections | 12 |
| Table 7 | Distribution configurations | 13 |
| Table 8 | Programmable relay board pinout | 14 |
| Table 9 | Input circuit breaker schedule, 250-800A | 68 |
| Table 10 | Output circuit breaker schedule, 250-800A. | 68 |
| Table 11 | Non-automatic breaker schedule, 250-800A | 68 |
| Table 12 | Event messages | 85 |
| Table 13 | Terminal commands | 88 |
| Table 14 | Value types | 90 |
| Table 15 | Group settings and values | 91 |
| Table 16 | Binary-hexadecimal conversions | 93 |
| Table 17 | Setpoint parameters | 102 |
| Table 18 | PDU setpoints | 104 |
| Table 19 | Standard settings for programmable relays | 109 |
| Table 20 | Input voltage | 115 |
| Table 21 | Output voltage. | 115 |
| Table 22 | System current ratings. | 115 |
| Table 23 | Electrical requirements | 116 |
| Table 24 | Unit short circuit withstand capability | 116 |
| Table 25 | Frame sizes | 117 |
| Table 26 | MTA plug pinout | 119 |
| Table 27 | DB9 pinout | 119 |
| Table 28 | RS-232 settings | 120 |
| Table 29 | Torque tightening | 144 |
| Table 30 | Branch circuit breakers | 144 |
| Table 31 | Programmable relay board settings record | 145 |
| Table 32 | Input contact isolator settings record | 146 |

IMPORTANT SAFETY INSTRUCTIONS

SAVE THESE INSTRUCTIONS

This manual contains important instructions that should be followed during the installation and maintenance of the Liebert Static Transfer Switch 2 Power Distribution Unit (STS2/PDU).

Read this manual thoroughly, paying special attention to the sections that apply to your installation, before working with the Static Transfer Switch 2 Power Distribution Unit. Retain this manual for use by installing personnel.

Refer to **1.2.1 - Handling Considerations** before attempting to move the unit.



WARNING

The unit is supplied by more than one power source. The unit contains hazardous voltages if any of the input sources are on, even when the unit is in bypass. To isolate the unit, turn off and lock out all input power sources.

Verify that all input power sources are de-energized and locked out before making connections inside unit.

Lethal voltages exist inside the unit during normal operation. Only qualified service personnel should perform maintenance on the STS2/PDU.



NOTE

Read the entire manual before installing or operating the system. Adhere to all operating instructions and warnings on the unit and in this manual.



WARNING

Under typical operation and with all STS2/PDU doors closed, only normal safety precautions are necessary. The area around the STS2/PDU should be kept free of puddles of water, excess moisture and debris.

ONLY qualified service personnel should perform maintenance on the Static Transfer Switch 2 Power Distribution Unit. When performing maintenance on any part of the equipment under power, service personnel and test equipment should be located on rubber mats. The service personnel should wear insulating shoes for isolation from direct contact with the floor.

One person should never work alone, even if all power is removed from the equipment. A second person should be standing by to assist and summon help in case an accident should occur.



WARNING

The input sources to the STS2/PDU must be grounded-wye sources. Input sources other than solidly grounded-wye sources may cause damage to the switch.

Liebert Corporation neither recommends nor knowingly sells this product for use with life support or other FDA-designated “critical” devices.

The Static Transfer Switch 2 Power Distribution Unit is suitable for indoor use only. Protect the unit from excessive moisture and install the unit in an area free from flammable liquids, gases and corrosive substances.

The unit is designed to operate from solidly grounded AC power sources only. Provide input over-current protection in accordance with the unit ratings. Wire and ground the unit according to national and local electrical safety codes. All wiring should be installed by a qualified electrician.

A thorough equipment inspection and supervised start-up by qualified service personnel are strongly recommended at these times:

1. Before unit is placed into service for the first time
2. After equipment relocation, and
3. After the unit has been de-energized for an extended period of time



CAUTION

This unit complies with the limits for a Class A digital device, pursuant to Part 15 Subpart J of the FCC rules and EN550022. These limits provide reasonable protection against harmful interference in a commercial environment. This unit generates, uses and radiates radio frequency energy and, if not installed and used in accordance with this instruction manual, may cause harmful interference to radio communications. Operation of this unit in a residential area may cause harmful interference that the user must correct at his own expense.



WARNING

Locate the center of gravity symbols and determine the unit's weight  before handling the cabinet.

1.0 UNPACKING AND INSPECTIONS

**NOTE**

Read the entire manual before beginning to install the STS2/PDU. Upon delivery of the STS2/PDU, the installer should perform the following steps to ensure a high-quality installation.

A high-quality installation begins on the receiving dock. The STS2/PDU and its packaging should be inspected when the unit is delivered. If the packaging is not damaged, unpack the unit and conduct internal inspection before beginning the installation process. This section discusses inspecting and unpacking the STS2/PDU.

1.1 External Inspections

1. While the STS2/PDU is still on the truck, inspect the equipment and shipping container(s) for any signs of damage or mishandling. Do not attempt to install the system if damage is apparent.
2. Upon receipt and before unpacking, inspect the shipping crate for damage or mishandling. Check the Shock-Watch™ indicator.
 - If the indicator is red, note on shipper's receipt and check for concealed damage.
 - If any damage as a result of shipping is observed, file a damage claim with the shipper within 24 hours and contact your local Liebert representative or Liebert Global Services at 1-800-543-2378 to inform them of the damage claim and the condition of the equipment.
3. Locate the bag containing the keys for the front access door. The bag is attached to the cabinet.
4. Compare the contents of the shipment with the bill of lading. Report any missing items to the carrier and to Liebert Global Services immediately.
5. Check the nameplate on the cabinets to verify that the model numbers correspond with the one specified. Record the model numbers and serial numbers in the front of this installation manual. A record of this information is necessary should servicing be required.
6. If unit is to be stored before installation, it is recommended to store the unit in a dry environment with temperatures in the range of -40 to 176°F (-40 to 80°C). Use original packing materials or other suitable means to keep the unit clean. When opening the shipping crate, use care not to puncture the container with sharp objects.

1.2 Unloading and Handling

**CAUTION**

When moving the unit by forklift, lift the unit from the rear so as to protect the front panel. Do not exceed a 15 degree tilt with the forklift.

Also, if you are moving the unit by forklift or pallet jack after it has been removed from the pallet, be aware of the location of the casters and leveling feet (if unit is so equipped) so as not to damage them.

Most STS2/PDU models are contained in one cabinet. The 800 amp units are contained in two cabinets that shipped on two pallets and connected together in the field.

The unit can be moved by forklift or pallet jack. However, because the weight distribution in the cabinet is uneven, use extreme care during handling and transporting.

See **1.2.2 - Unit Preparation** for instructions on removing the STS2/PDU from the pallet.

1.2.1 Handling Considerations

The STS2/PDU is bolted to a wood shipping pallet to allow handling by forklift equipment or a pallet jack.



WARNING

Exercise extreme care when handling STS2/PDU cabinets to avoid equipment damage or injury to personnel.

The cabinet can be safely tilted 15 degrees in any direction by forklift.

If moving the unit up a ramp on its casters (if the unit is so equipped) or a pallet jack, ensure that the incline does not exceed 15 degrees.

Locate the center of gravity symbols and determine the unit's weight  before handling the cabinet.

Check the unit size and weight. Refer to the cabinet drawings furnished with the unit for size and weight. Typical cabinet dimensions are shown in **Figures 7** through **22**. Typical unit crated weights are:

Table 1 Shipping weights (typical)

| Model | Weight - lbs. (kg) |
|----------------|---------------------|
| 250A | 3730 lbs. (1692 kg) |
| 400A | 4900 lbs. (2132 kg) |
| 600A | 5580 lbs. (2531 kg) |
| 800A Module A* | 4052 lbs. (1838 kg) |
| 800A Module B* | 4595 lbs. (2084 kg) |

*800A ships on two separate pallets

Plan the route. Review the route over which the unit will be transported to its installation location to ensure that all passages are large enough to accommodate the unit and support the weight.

Check for any non-negotiable corners or offsets in hallways. Before moving the unit to the intended location, review **2.0 - Location Considerations**.

1.2.2 Unit Preparation

The unit can be removed from the pallet before it is moved to its location.

Complete the following steps to properly remove the STS2/PDU from the shipping pallet:

1. Set the pallet in a level area with enough room to maneuver and remove the unit.
2. Remove the bolts holding the unit to the shipping pallet (located in the base of the unit).
3. Remove the shipping blocks from under the frame of the unit.
4. Use a forklift to raise the unit off the pallet and onto the floor. On the 250A unit ensure that the forklift is clear of the unit's casters and leveling feet. Lift the unit from the rear.
5. Conduct an internal inspection of the unit. See the list in **1.3 - Internal Inspections**.

1.3 Internal Inspections

After the STS2/PDU has been unpacked, conduct an internal inspection:

1. Verify that all items have been received.
2. If spare parts were ordered, verify their arrival.
3. After the Static Transfer Switch 2 Power Distribution Unit has been removed from the pallet, open the door and remove cabinet panels to check for shipping damage to internal components.
4. Check for loose connections or unsecured components in the cabinet(s).
5. Check for any unsafe condition that may be a potential safety hazard.

After the STS2/PDU has been inspected and no problems are found, the unit can be moved to its installation location. If using a forklift, remember to lift the unit from the rear.

2.0 LOCATION CONSIDERATIONS

The STS2/PDU should be placed in a clean, cool and dry location. The 250A unit without an output cabinet requires only front access for installation and maintenance. Both front and side access are required for installation and maintenance of 400-800A units and 250A units with output cabinet. The output cabinet comes factory installed or either the right or left side depending on how it was ordered. It cannot be moved from one side to the other in the field.

Adequate space is required above the unit for conduit (if configured as such) and cooling air flow. This section provides specific information for these considerations.

The unit is designed with top and bottom cable terminations to allow maximum flexibility in its installation. Units with output inline panelboards are bottom exit only. If bottom cable entry and exit is used, sufficient cable bending space must be provided by a raised floor or a floor stand.

For dimensions of each unit, see **Figures 7 through 22**. If your unit is equipped with an optional key lockout switch, see **Figures 13 through 21** for the location of that switch.

2.1 Recommended Minimum Service Clearances

The recommended service clearances are at the front and side, if equipped with output cabinet. The minimum service clearance required by the National Electrical Code (NEC) Article 110-26 is 36 in. (91cm) for units with voltages up to 150V to ground and 42 in. (107cm) for units with voltages over 150V to ground. Clearance of at least 18 in. (46cm) is required above the unit for cooling air flow.

2.2 Heat Output

The unit produces minimal heat during normal operation.

Table 2 Heat output

| Switch Size | Heat Output BTU/Hr (kW) |
|-------------|----------------------------|
| 250A | 12,590 (3.69) |
| 400A | 20,140 (5.90) |
| 600A | 30,200 (8.85) |
| 800A | 40,270 (11.80) |

2.3 Operating Environment

The unit is designed to be installed indoors where the ambient air temperature is in the range of 32° to 104°F (0°C - 40°C) with a relative humidity of 0% to 95% non-condensing, up to an altitude of 4000 feet (1200 meters).

2.4 Altitude

The standard units are designed for full load operation up to 4000 feet (1200m) above sea level. See **Figure 1** for recommended deratings for altitudes greater than 4000 feet (1200m).

Figure 1 Recommended derating for high altitude operation

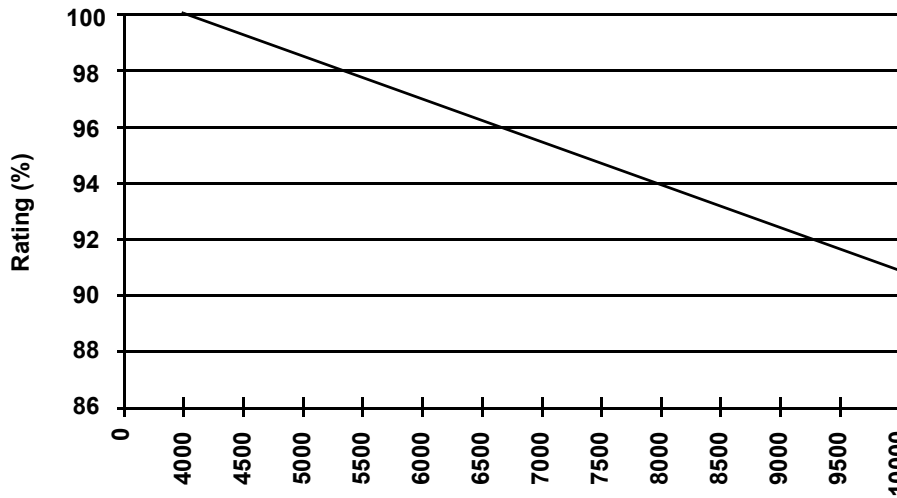

Operation at full load at a higher altitude can be accommodated in ambient temperatures less than 104°F (40°C) ambient. **Figure 2** shows the maximum allowable ambient temperature for full load operation at altitudes above 4000 feet (1200m).

Figure 2 Maximum ambient temperature for full load operation at higher altitudes

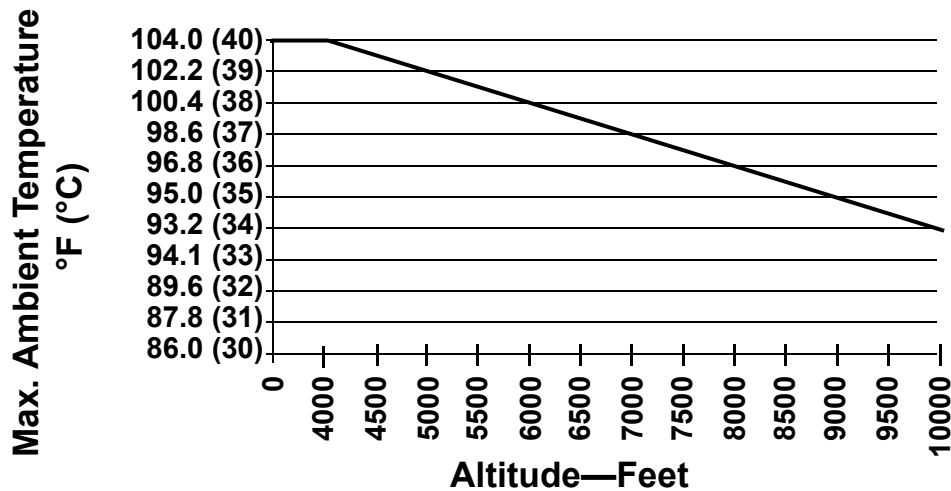

Table 3 Altitude conversion—feet to meters

| Feet = Meters | |
|---------------|--------------|
| 4000 = 1200 | 7500 = 2286 |
| 4500 = 1372 | 8000 = 2438 |
| 5000 = 1524 | 8500 = 2591 |
| 5500 = 1676 | 9000 = 2743 |
| 6000 = 1829 | 9500 = 2896 |
| 6500 = 1981 | 10000 = 3048 |
| 7000 = 2134 | |

3.0 LOCATING THE STS2/PDU

This section provides instructions for leveling the STS2/PDU and anchoring the unit to the floor, should that be required.

3.1 Anchoring the Unit to the Floor

The STS2/PDU can be anchored to the concrete floor to ensure stability for the unit in the event of seismic activity.

3.2 Leveling of the 250A Only STS2/PDU Without Anchoring

The 250A Static Transfer Switch 2 Power Distribution Unit is furnished with casters and leveling feet. After final positioning of the unit, adjust the leveling feet located in each corner of the frame base to level and stabilize the unit.

For leveling feet details, see **Figures 7** through **11**.

4.0 POWER AND CONTROL WIRING

All power and control wiring must be installed by a licensed, qualified electrician. All power and control wiring must comply with the National Electrical Code and all applicable local codes. Unless otherwise labeled, use the recommended tightening torque shown in **Table 29**.

The input power busbars are accessible through the front of the unit. Liebert's 250A units have PEM nut inserts designed to allow one-handed tightening. Busbars in the 400-800A units are supplied with holes to accommodate two-hole lugs.

Cables can be installed through the top or bottom of the unit through removable conduits plates. Units with output inline panelboards are bottom exit only for output cables.

See **Figures 12** through **21** for wiring entrance locations.

4.1 Input and Output Power Connections

The input power connections are made to the busbars provided inside the unit (see **Figures 26** through **31**). These busbars are accessible through the front of the unit.

Output power connections are handled two different ways, depending on the type of distribution used. Power connections on standard units with an output breaker are made to the busbars inside the unit. These busbars are accessible through the front on 250A units and on the side on 400-800A units. See **Figures 26** through **31** for details on the busbars. Power connections on units with panelboard distribution are made directly to the panelboard breakers. Busbars are provided in the output cabinet for ground and neutral connections.



WARNING

Verify that all input power and control circuits are de-energized and locked out before making connections inside unit.

The two input power feeds (sources) to the STS2/PDU should be from two independent sources to avoid a common source failure.

To ensure proper operation of the STS2/PDU, the two input sources must be the same nominal voltage level and phase rotation.

For uninterrupted automatic transfer, the two input sources should be synchronized within 15 degrees.



CAUTION

The input sources to the STS2/PDU must be grounded-wye sources. Input sources other than solidly grounded-wye sources may cause damage to the switch.

The STS2/PDU is designed for operation with 3-wire, solidly grounded sources only.

See **Figures 3** through **6** for typical one-line diagrams. Refer to **Figures 26** through **31** for electrical field connections on all units.

Figure 3 Typical STS2/PDU, one-line diagram

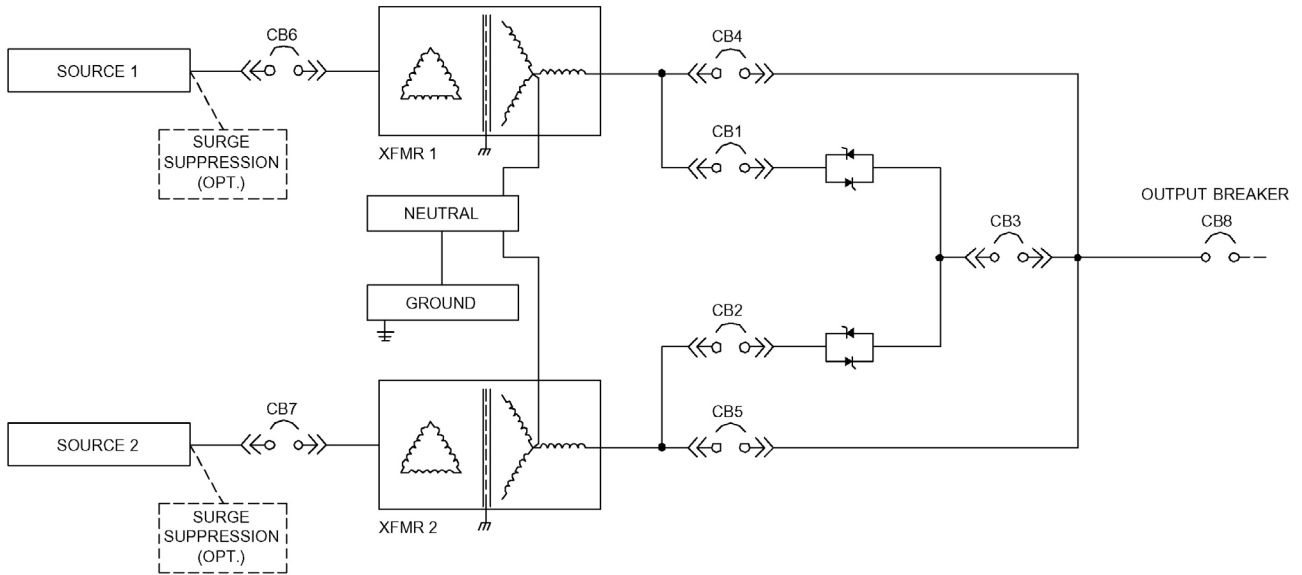

Figure 4 Typical STS2/PDU, one-line diagram, with dual static switch output circuit breakers (not available on 250A units)

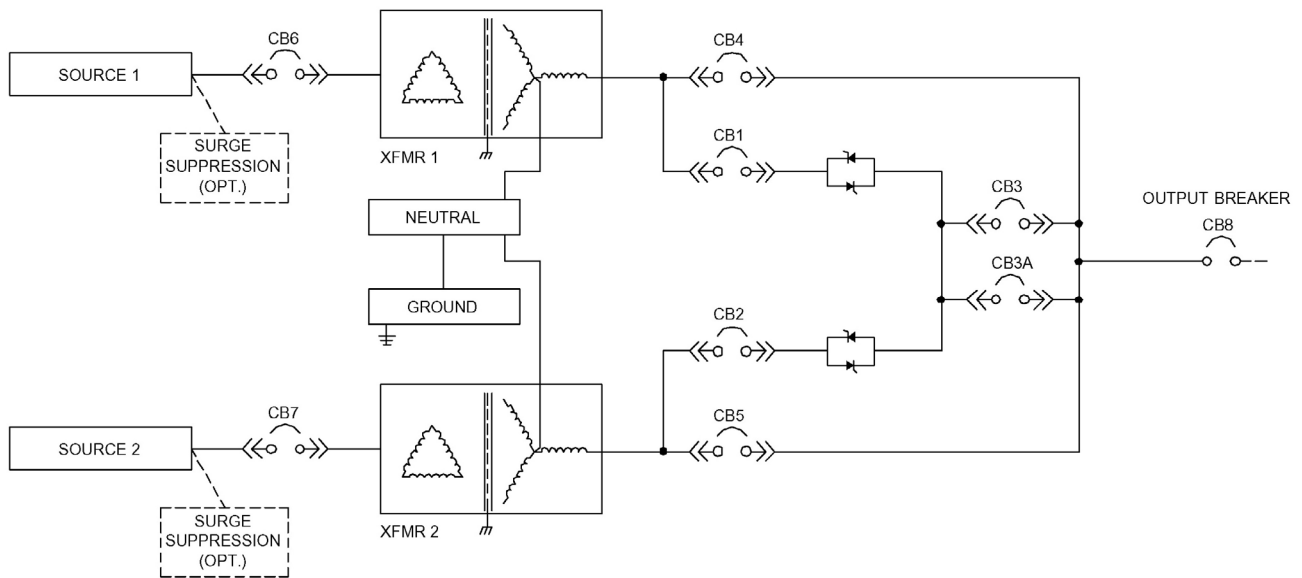

Figure 5 Typical STS2/PDU, one-line diagram, with inline distribution, dual static switch output circuit breakers

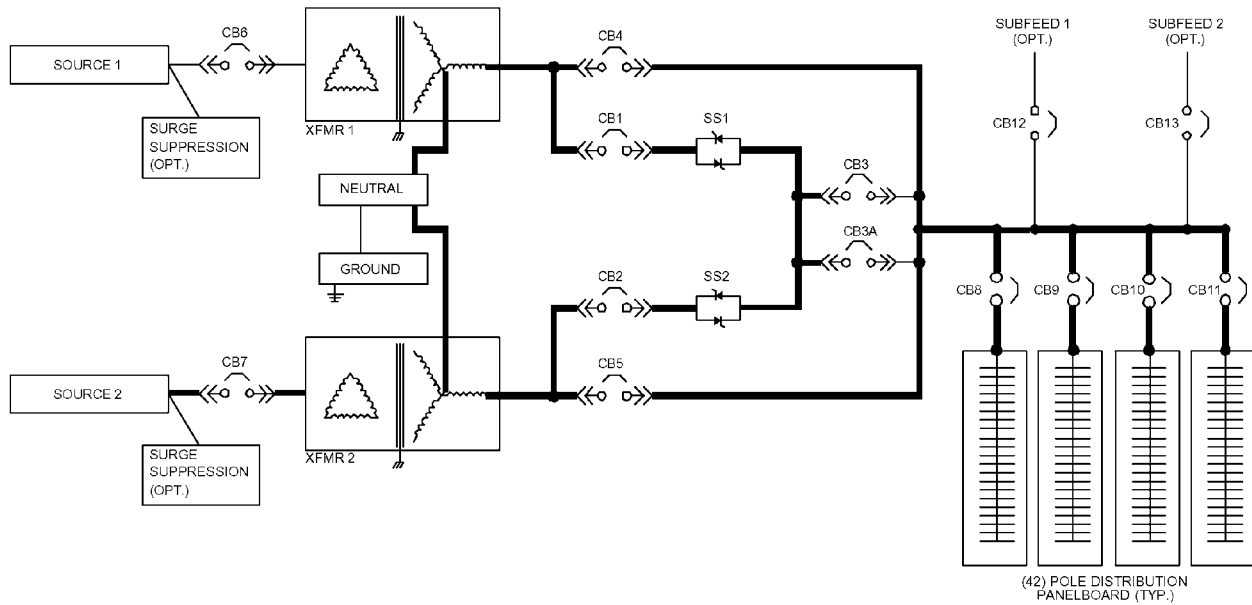
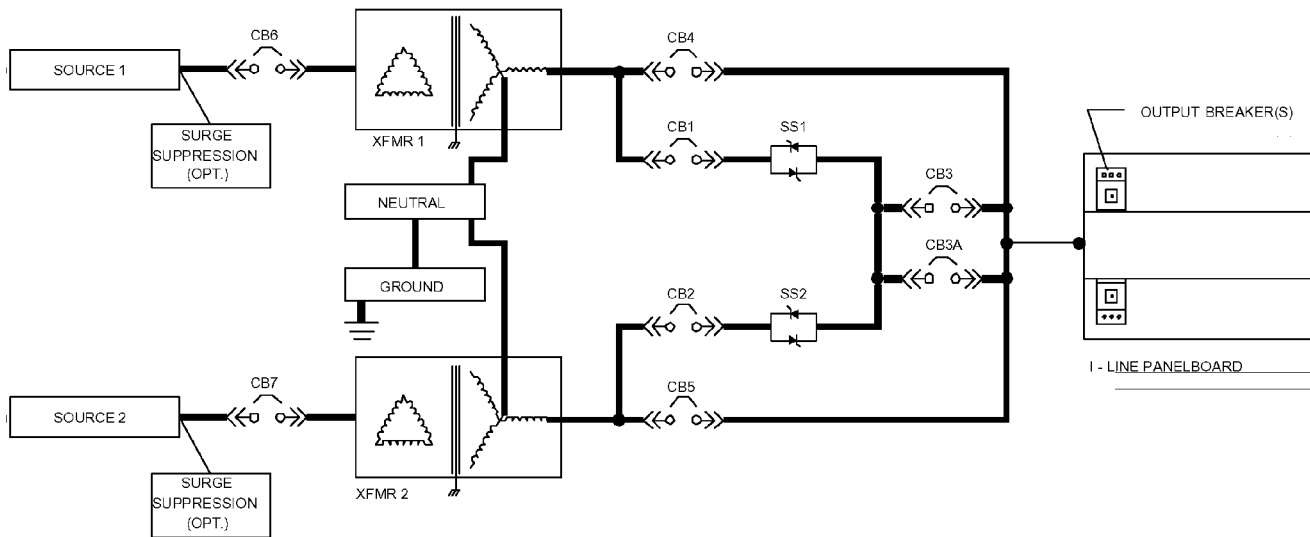

Figure 6 Typical STS2/PDU, one-line diagram, with I-Line distribution, dual static switch output circuit breakers



The input and output power wire size should be based on the overcurrent protection device, observing the NEC and local codes.

The STS2/PDU output power, ground and neutral busbars accommodate a wide range of wire sizes. The STS2/PDU busbars accommodate standard two-hole lugs.

Table 4 Input/output conduit plate specifications

| Rating | Maximum Number of Conduits | Size, in. |
|----------|----------------------------|--------------|
| 250A | 12 | 2" |
| | 8 | 2-1/2" |
| | 6 | 3" or 3-1/2" |
| 400-600A | 6 | 2" |
| | 4 | 2-1/2" or 3" |
| 800A | 6 | 2-1/2" |
| | 5 | 3" or 3-1/2" |

4.2 System Grounding

Equipment grounding—Grounding is primarily for equipment and personnel safety, although proper grounding also enhances equipment performance.

All input and output power feeds must include an equipment grounding means as required by the NEC and local codes.

An insulated equipment ground conductor is recommended to run with each input and output power feed. The equipment ground conductors should be at least the minimum size conductor per the NEC based on the upstream overcurrent protection device.



WARNING

If conduit is used as a grounding means, adequate electrical continuity must be maintained at all conduit connections. The use of isolating bushings with a metal conduit can be a safety hazard and is not recommended.

4.3 Control Wiring Connections

No control wiring is needed on the standard STS2/PDU. Certain options and remote monitoring configurations require external control wiring. See **6.0 - Options** for details.

The customer must supply control wiring to the STS2/PDU for connection to any monitoring or communication options. Top and bottom removable conduit plates are provided for control wiring conduit.

Control cables can be installed through the top or bottom of the unit through removable control conduit plates. A top hat is provided on the 400-600A units for connecting the top entry control wiring conduits (see **Figures 13** through **21**). The top hat is turned upside down and ships inside the unit. It must be removed from the unit and flipped 180 degrees before being reinstalled (see **Figure 49**). The control wiring top hat does NOT contain any knockouts for conduit. The installer must drill the appropriate-sized holes for the conduit before attaching to the top of the STS2/PDU.

See **Figures 47** and **48** for arrangement of optional cards.

4.4 Remote Source Selection Wiring

An optional Remote Source Selection board may be installed in your STS2/PDU. This board is installed in the same bay as the communications options. See **Figures 47** and **48** for the location of these options. See **Figure 56** for information on the control wiring for the Remote Source Selection option.

The Remote Source Selection allows you choose the preferred input source from a remote location.

Terminal connections allow the customer to remotely select a source to be the preferred source in the same process as the local source transfer selection.

If both the input contacts are closed, the current selected preferred source shall be retained. If the unit's preferred source selection and Remote Source Selection are active at the same time, the STS2/PDU follows the last request for a preferred source change, regardless of whether it was from the local or Remote Source Selection controls.

A six pin terminal block provides the Remote Source Selection connections. Two pairs of wires are used from the switch to trigger the source selection. You can select the type of switch used for this remote control. Connections are made to four of the connections, using Form A dry contacts. The contacts are numbered left to right:

Table 5 Remote source selection terminal block

| Contact | Connection |
|---------|-----------------|
| 1 | Source 1 |
| 2 | Isolated ground |
| 3 | Source 2 |
| 4 | Isolated Ground |
| 5 | DO NOT USE |
| 6 | DO NOT USE |

See **10.3 - Enabling Remote Source Selection** for instructions on enabling the Remote Source Selection option.

4.5 Power Supply

The STS2/PDU is supplied with redundant power supplies that are designed to operate from a voltage range of 200V to 600V. The unit is set at the factory to match the nameplate voltage. Field adjustments are not necessary. If the unit needs to operate at a voltage other than what is listed on the nameplate, contact Liebert Global Services or your local Liebert representative. **Table 6** provides transformer tap information.

Table 6 Terminal block 1 and terminal block 2 wire connections

| Voltage | Connect | | Connect | | Jumper Between |
|---------|-----------|-----------|-----------|-----------|----------------|
| | F1 TB1-XX | F2 TB1-YY | F3 TB2-XX | F4 TB2-YY | |
| 200 | 1 | 9 | 1 | 9 | 1-7 |
| 220 | 2 | 12 | 2 | 12 | 6-8 |
| 380 | 1 | 8 | 1 | 8 | 2-7 |
| 415 | 1 | 10 | 1 | 10 | 4-7 |
| 600 | 1 | 12 | 1 | 12 | 6-7 |
| 208 | 1 | 10 | 1 | 10 | 1-7 |
| 240 | 1 | 11 | 1 | 11 | 1-7 |
| 400 | 1 | 9 | 1 | 9 | 3-7 |
| 480 | 1 | 11 | 1 | 11 | 5-7 |



CAUTION

Using **Table 6**, ensure that the wiring for the control transformers matches the input voltage for the unit.

Improper wiring could result in blown fuses.

5.0 OUTPUT POWER WIRING

The STS2/PDU standard model is provided with a circuit breaker for connecting to the load or a remote distribution cabinet. Other distribution configurations are available.

The three main types of distributions available for the STS2/PDU are:

- **Output Breaker**
- **Inline Panelboards**—two panelboards (84 poles) on 250A units and four panelboards (168 poles) on 400-800A units. Square D[®] and General Electric panelboards are available to accommodate bolt-in or plug-in breakers.
- **Square D I-Line[®] Panelboard**—designed to accommodate up to 10 plug-in breakers from 100A to 250A. Additionally, 300A to 400A breakers are available on 800A units.

For other optional distribution methods, contact your local Liebert representative or call 1-800-LIEBERT.

The STS2/PDU distribution may be mounted on either the right or left side at the customer's option. Location of output conduit connections is affected by the location of the output cabinet. See **Figures 8, 9, 12, 13, 16 and 17** for wiring a right-side distribution configuration and **Figures 10, 11, 14, 15, 18 and 19** for wiring a left-side distribution configuration. See **Figures 23 through 44** for wiring.

See **Table 7** for wiring the various output options.

5.1 Customer Connections

The customer is responsible for connections from the STS2/PDU distribution to the connected load, either directly or through remote distribution cabinets.

Table 7 Distribution configurations

| Distribution Type | For Details See Electrical Output Field Connections |
|---------------------------|---|
| Output Breaker | |
| 250A | Figure 23 |
| 400-600A | Figure 33 |
| 800A | Figure 35 |
| Inline Panelboards | |
| 250A | Figure 30 |
| 400-800A | Figure 31 |
| I-Line (Square D) | Figure 32 |

6.0 OPTIONS

This section discusses the options available for the STS2/PDU. The communications options are also discussed in **12.0 - Communication Interfaces**.



WARNING

All options must be installed by Liebert Global Services or Liebert factory-authorized service provided by a Liebert distributor. The option area and customer control cable area contain hazardous voltages if any of the input sources are on, even when the unit is in bypass. Turn OFF all power sources before installing customer control cables to any option.

6.1 Programmable Relay Board

The programmable relay board (PRB) provides a means to trigger an external device when an event occurs in the STS2/PDU. Each PRB has 8 channels. Each channel has two sets of Form-C dry contacts, rated 1A @ 30VDC or 250mA @ 125VAC.

Any alarm or event may be programmed to any channel or channels. Up to ten (10) events may be programmed to a relay. If multiple events are grouped to one relay, group the events logically to simplify troubleshooting when an event is triggered. The same alarm or event may be programmed to more than one channel. Up to two programmable relay boards can be installed in the STS2/PDU for a total of 16 channels. Programming is performed through the touch screen display.

See **Configuring the Programmable Relay Board Settings on page 109** for default settings and instructions for reconfiguring the relays. See **Figures 47 and 48** for the location of the PRB. See **Figure 50** for wiring details. **Table 8** provides the PRB pinout.

Table 8 Programmable relay board pinout

| | Channel | Pin No. | C | N.C. | N.O. | |
|-----|---------|---------|-------|------|------|----|
| TB1 | CH1 | A | 1-3 | 1 | 2 | 3 |
| | | B | 4-6 | 4 | 5 | 6 |
| | CH2 | A | 7-9 | 7 | 8 | 9 |
| | | B | 10-12 | 10 | 11 | 12 |
| | CH3 | A | 13-15 | 13 | 14 | 15 |
| | | B | 1-3 | 1 | 2 | 3 |
| TB2 | CH4 | A | 4-6 | 4 | 5 | 6 |
| | | B | 7-9 | 7 | 8 | 9 |
| | CH5 | A | 10-12 | 10 | 11 | 12 |
| | | B | 13-15 | 13 | 14 | 15 |
| | CH6 | A | 1-3 | 1 | 2 | 3 |
| | | B | 4-6 | 4 | 5 | 6 |
| CH7 | A | 7-9 | 7 | 8 | 9 | |
| | B | 10-12 | 10 | 11 | 12 | |
| TB3 | CH8 | A | 13-15 | 13 | 14 | 15 |
| | | B | 1-3 | 1 | 2 | 3 |

Key: N.O. = Normally Open; N/C. = Normally Closed; C = Common

Note: Pin 16 not used on TB1, TB2 and TB3.

6.2 Input Contact Isolator Board

The Input Contact Isolator Board (ICI) provides an STS2/PDU module interface for up to eight external user alarm or message inputs to be routed through the Static Transfer Switch 2 Power Distribution Unit's alarm network. The eight contacts are normally open dry contacts. When a contact closes, an event is triggered.

The Input Contact Isolator options are configured through the Input Contact Isolator dialog box, which is accessed from the Comm Option dialog box on the touch screen display. You also can program the alarm messages through this dialog box. See **Configuring the Input Contact Isolator Settings on page 108** for instructions on configuring the connections.

See **Figures 47 and 48** for the location of the ICI. See **Figure 51** for wiring details.

6.3 Comms Board

The Comms Board provides a communication interface to Liebert SiteScan, site monitoring product and/or an external or internal modem. SiteLink-12 or SiteLink-4 is required for SiteScan to communicate with the STS2/PDU.

The Comms Board is equipped with an RS-422 communication port for communication to a Liebert SiteScan monitoring system using a 2-wire twisted pair for reliable communication up to 1000 meters (3281 feet). Information available from the RS-422 port includes the present switch status information, all monitoring parameters and all active alarms.

The Comms Board is equipped with a modem interface for remote reporting of the present switch status information, alarm history information and the history of status screens that are triggered upon a major alarm event. The monitoring system software also supports an auto-dial feature that allows the system to automatically dial programmed phone numbers by way of the modem to report designated alarm conditions.

Programming the Comms Board is performed through the touch screen display. See **Comm Options on page 105** for details.

See **Figures 47** and **48** for the location of the Comms Board. See **Figure 52** for information on the control wiring.

6.4 Internal Modem

The Internal Modem is an option that must be ordered separately. An external modem is available from third party sources. The Internal Modem is capable of dialing out from the STS2/PDU or accepting incoming calls and connecting to a remote terminal or computer. Using an ASCII Query and Answer format the modem connection can be used to view system status and alarms. The modem provides all information normally available on the LCD of the STS2/PDU. No control functions are available via the modem, such as making transfers, selecting a preferred source or changing configurations.

The modem can also be configured to dial out two different telephone numbers (any combination of modem or pager numbers).

The connection to this modem is through a standard RJ-11 port.

See **Figures 47** and **48** for the location of the internal modem. See **Figure 53** for more information on the internal modem.

Programming the modem is performed through the touch screen display, see **Configuring the Modem on page 105** for details.

The modem commands are shown in **Table 13**.

6.5 Network Interface Card (NIC)

An OpenComms Network Interface Card (NIC) enables the STS2/PDU to communicate to a network management system (NMS). The NIC provides the internal hardware and software to communicate, via SNMP, to any I.P.-based Ethernet network through an RJ-45 connector using Category 5 cabling.

The NIC provides redundant paths for communications that make it possible to connect to a Building Management System (BMS) using Modbus, while simultaneously communicating to a NMS through SNMP. A terminal block provides the connection to Modbus.

See **Figures 47** and **48** for the location of the NIC. See **Figure 54** for control wiring information.

If you have questions about the NIC, refer to the OpenComms Network Interface Card Installation and Users Guide.

6.6 Remote Source Selection

The Remote Source Selection allows the preferred input source to be chosen from a remote location. A user supplied normally open dry contact allows the user to remotely select a source to be the preferred source in the same process as the local source transfer selection.

If both the input contacts are closed, the current selected preferred source shall be retained. If the unit's preferred source selection and Remote Source Selection are active at the same time, the STS2/PDU follows the last request for a preferred source change, regardless of whether it was from the local or Remote Source Selection controls.

See **10.3 - Enabling Remote Source Selection** for instructions on enabling the Remote Source Selection.

See **Figures 47** and **48** for the location of the Remote Source Selection option.

See **4.4 - Remote Source Selection Wiring** and **Figure 56** for information on the control wiring.

6.7 Key Lockout Switch

The key lockout switch activates a software lockout of the touch screen display to prevent manual transfers and configuration changes. When locked out, the touch screen becomes a read-only display. A key is needed to do manual transfers or change settings.

The alarm silence button is not disabled when in the lockout position.

The switch is located on the front of the unit next to the display; it is behind the front door but can be operated without opening the front door. See **Figures 20** through **22** for the key lockout switch location on each unit.

See **13.2.1 - Security** and **Figure 65** for instructions on using the key lockout switch.

6.8 Static Switch Redundant Output Breaker

A plug-in, non-automatic circuit breaker is provided which allows redundancy in the static switch output power path. The breaker is connected in parallel with the static switch output plug-in non-automatic circuit breaker.

6.9 Inline Panelboards

An output distribution cabinet with either Square D or General Electric inline panelboards with copper bus to accept bolt-in or plug-in circuit breakers. Each panelboard is individually protected by a 225A, 240V, 3-pole panelboard main circuit breaker.

Each panelboard includes a separate isolated neutral bus bar and a safety-ground bus bar for the neutral and safety-ground connections for at least 42 output circuits.

6.10 I-Line Panelboards

An output distribution cabinet with one vertically mounted Square D I-Line panelboard with copper bus to accept Square D three phase plug-in circuit breakers. The panelboard shall be totally enclosed with an accent cover.

6.11 Subfeed Breakers

Breakers for feeding remote panelboard(s) or other loads. Available in ratings of 225A or 400A.



NOTE

Only available on units with inline panelboards. 400A breaker not available on 250A units.

6.12 K-Factor Transformers

K20-rated double-shielded copper isolation transformer specially designed to accommodate highly nonlinear loads in accordance with UL 1561 (in place of standard isolation transformer).

6.13 Surge Suppression System

A fused and monitored high-energy, 80 kAmp/phase surge suppression system by Control Concepts connected to each input of the unit for superior surge suppression.

7.0 INSTALLATION DRAWINGS

Figure 7 Outline drawing, 250A STS2/PDU

NOTES:

1. ALL DIMENSIONS ARE IN INCHES AND (MILLIMETERS).
2. APPROX. WEIGHT - 3,310 LBS. (1510 KG).
3. 18" (457MM) CLEARANCE ABOVE UNIT REQUIRED FOR AIR EXHAUST.
4. INSTALLATION AND SERVICE ACCESS REQUIRED IN FRONT.
5. KEEP CABINET WITHIN 15 DEG. OF VERTICAL WHILE HANDLING.
6. COLOR - IBM OFF WHITE.
7. UNIT BOTTOM IS STRUCTURALLY ADEQUATE FOR FORKTRUCK HANDLING.
8. HEAT OUTPUT: APPROX. 12,590 BTU/HR (3.69 KW/HR).
9. THREADED MOUNTING HOLES USED FOR SEISMIC ANCHORING OR FLOOR-STAND. NOTE: IF FLOORSTAND IS USED THE WEIGHT OF THE UNIT MUST BE SUPPORTED UNDER ALL CASTERS.
10. EACH MOUNTING LOCATION IS SUPPORTED BY (2) 10 GA. (.135") GALVANIZED STEEL. THE THREADED 12MM INSERT IS APPROX. 3/4" DEEP. MOUNTING BOLTS MUST BE THREADED INTO UNIT MOUNTING HOLES FROM UNDERNEATH UNIT BASE.
11. OPEN DOORS TO REPLACE AIR FILTER, DISPOSABLE TYPE SIZE 1 X 25 X 25.
12. TOP AND BOTTOM CABLE ENTRY AVAILABLE THROUGH REMOVABLE ACCESS PLATES. REMOVE, PUNCH TO SUIT CONDUIT SIZE AND REPLACE.

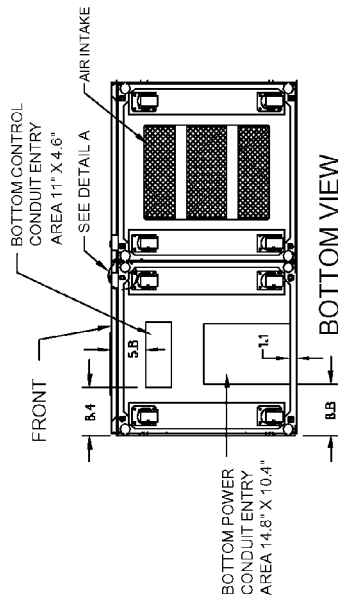
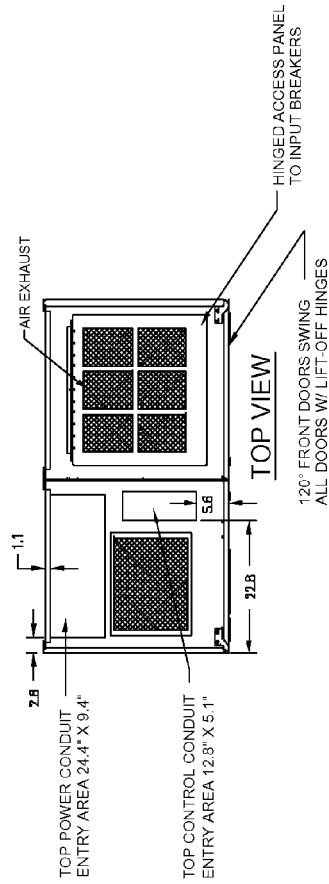
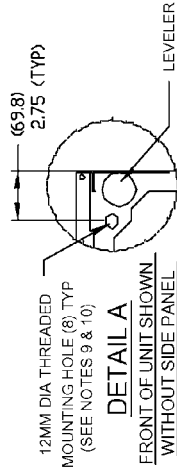
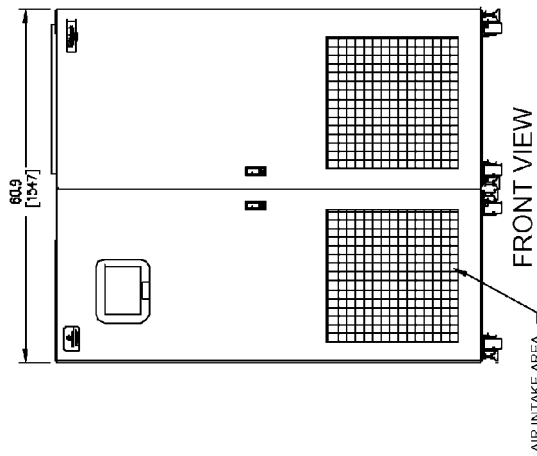
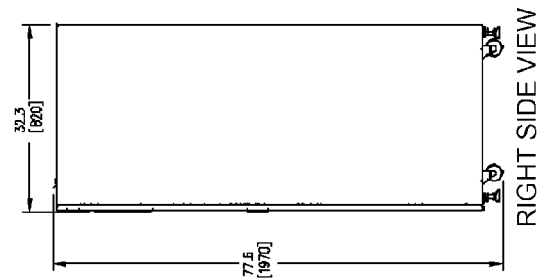

1050 DEARBORN DRIVE,
COLUMBUS, OHIO 43229

DWG. NO. PSP11200
REV. NO. 1

DATE 12/18/03
FILE NAME: STS2/PDU/OUTLINE/PSP11200/01

OUTLINE DRAWING
250 AMP
STS2/PDU

DRAWN BY
V. CARMONA
CHK BY

REF. DWG.

Figure 8 Outline drawing, 250A STS2/PDU with right side I-Line distribution

NOTES:

1. ALL DIMENSIONS ARE IN INCHES AND (MILLIMETERS).
2. APPROX. WEIGHT - 3530 LBS. (1601 KG).
3. 18" (457MM) CLEARANCE ABOVE UNIT REQUIRED FOR AIR EXHAUST.
4. INSTALLATION AND SERVICE ACCESS REQUIRED IN FRONT AND RIGHT SIDE ONLY.
5. KEEP CABINET WITHIN 15 DEG. OF VERTICAL WHILE HANDLING.
6. COLOR - IBM OFF WHITE.
7. UNIT BOTTOM IS STRUCTURALLY ADEQUATE FOR FORKTRUCK HANDLING.
8. HEAT OUTPUT: APPROX. 12,590 BTU/HR (3.69 KW/HR).
9. THREADED MOUNTING HOLES USED FOR SEISMIC ANCHORING OR FLOOR STAND. NOTE, IF FLOORSTAND IS USED THE WEIGHT OF THE UNIT MUST BE SUPPORTED UNDER ALL CASTERS.
10. EACH MOUNTING LOCATION IS SUPPORTED BY (2) 10 GA. (135") GALVANIZED STEEL. THE THREADED 12MM INSERT IS APPROX. 3/4" DEEP. MOUNTING BOLTS MUST BE THREADED INTO UNIT MOUNTING HOLES FROM UNDERNEATH UNIT BASE.
11. OPEN DOORS TO REPLACE AIR FILTER. DISPOSABLE TYPE SIZE 1 X 25 X 25.
12. TOP AND BOTTOM CABLE ENTRY AVAILABLE THROUGH REMOVABLE ACCESS PLATES. REMOVE, PUNCH TO SUIT CONDUIT SIZE AND REPLACE.

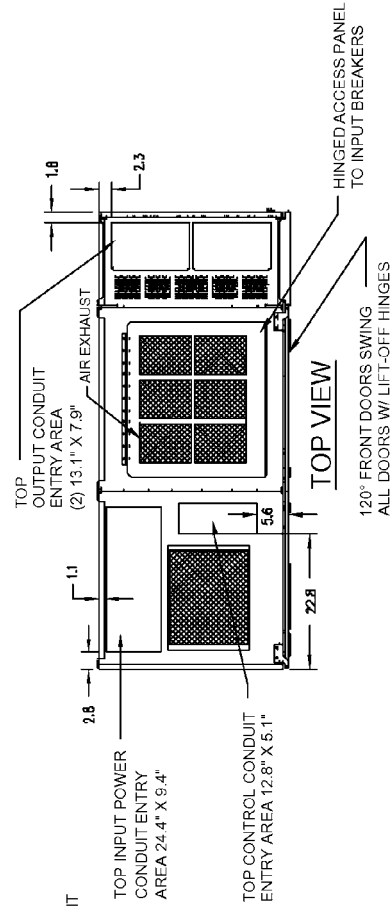
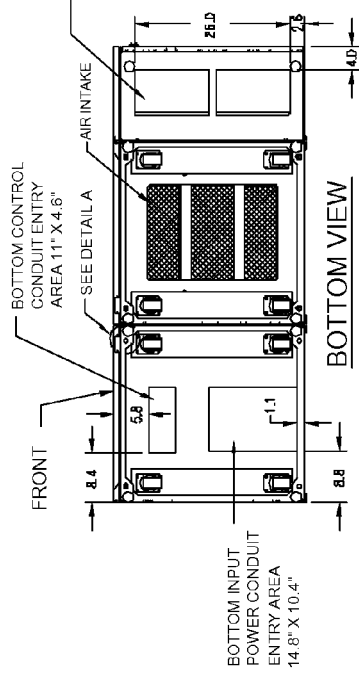
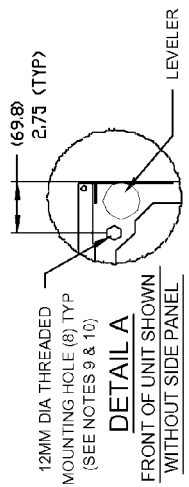
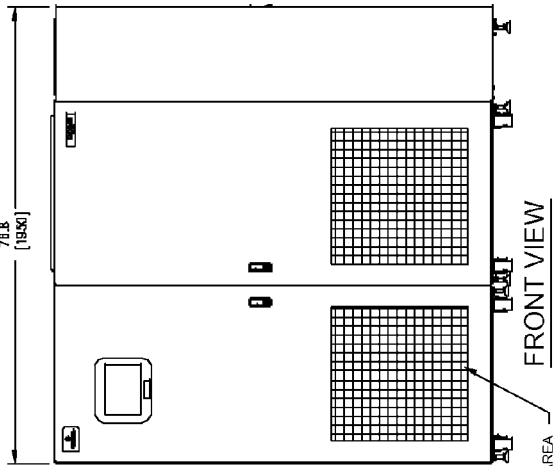
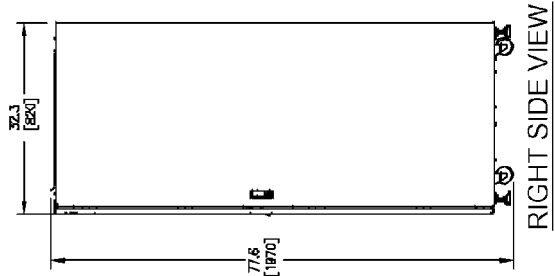

DRAWN BY
V.CARMONA
CHK BY
REF. DWG.

OUTLINE DRAWING
250 AMP
RIGHT SIDE MOUNTED
I-LINE DISTRIBUTION
STS2/PDU

DWG. NO. PSP11206
REV. NO. DATE 12/18/03

Leibert
1050 DEARBORN DRIVE
COLUMBUS, OHIO 43229



Figure 9 Outline drawing, 250A STS2/PDU with right side inline distribution

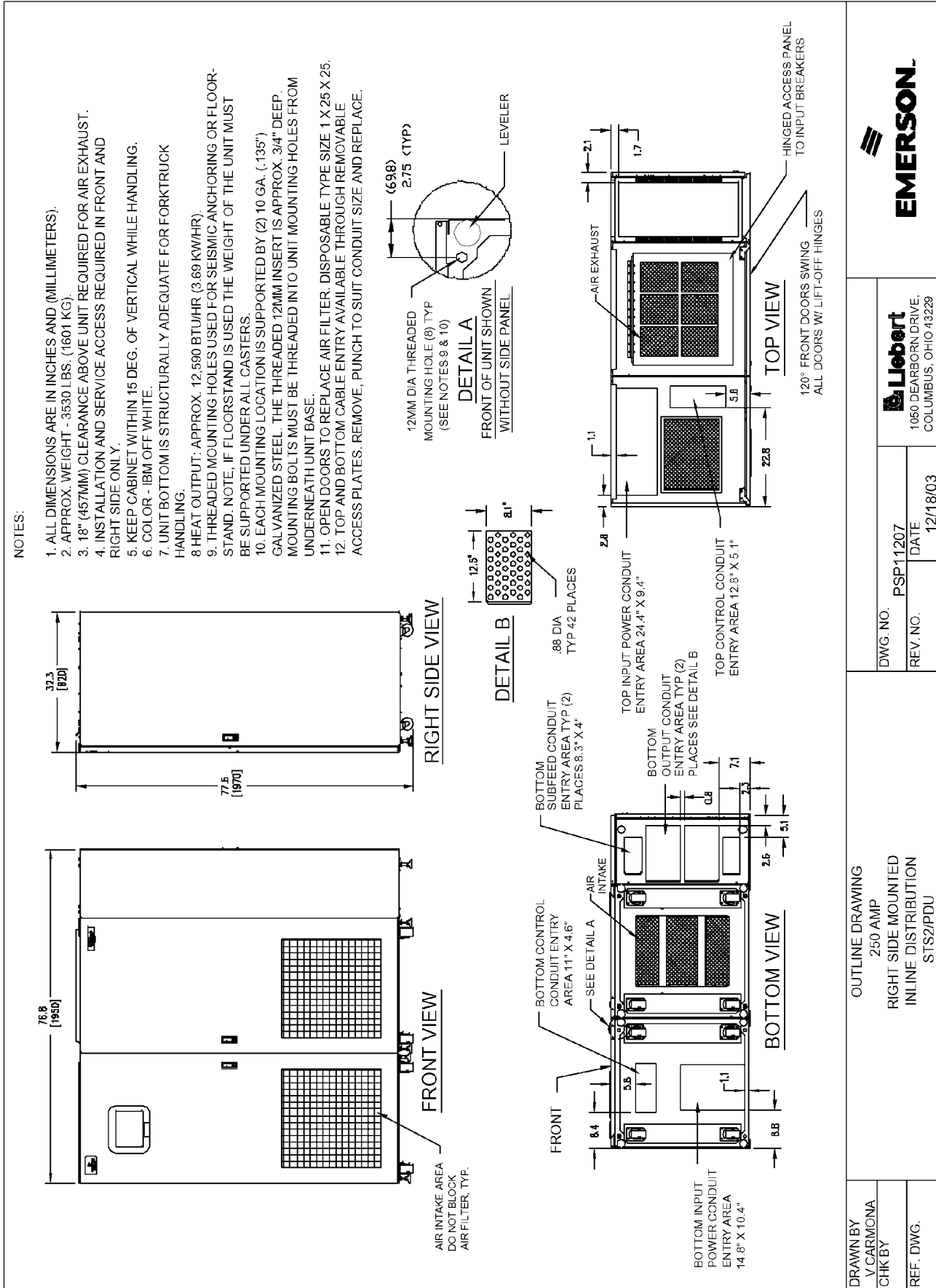
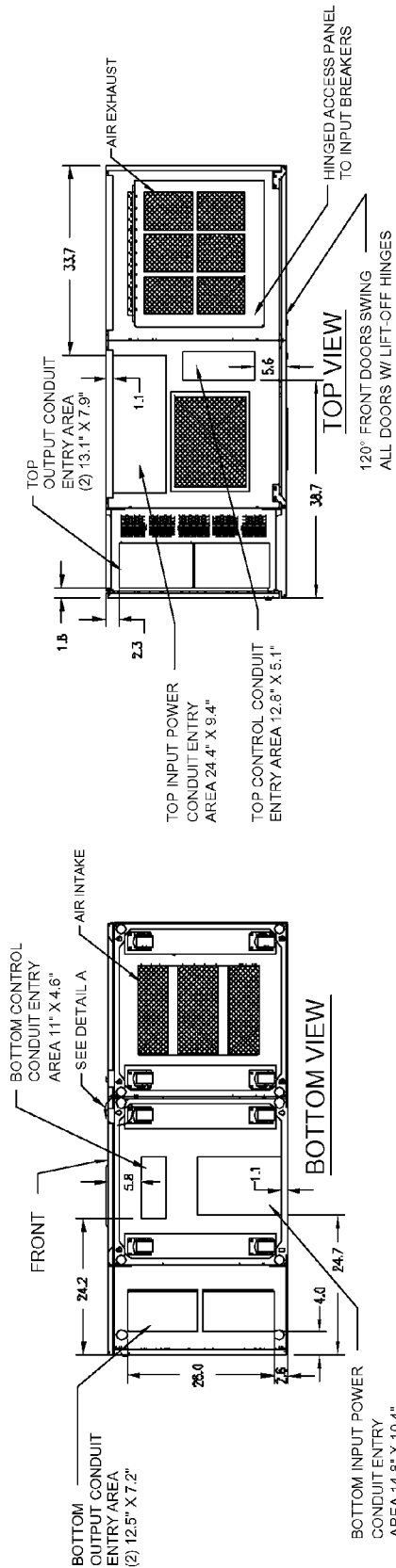
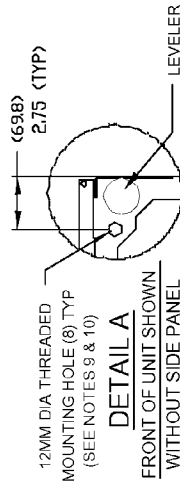
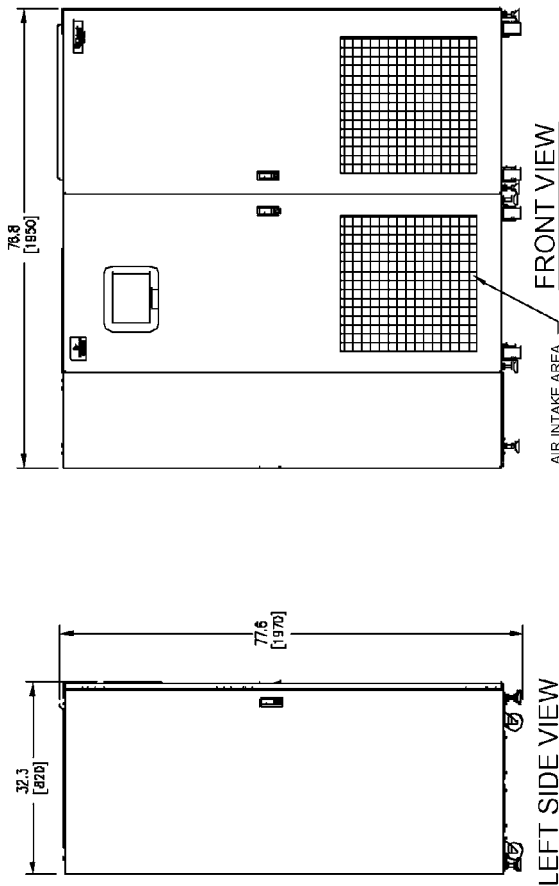

Figure 10 Outline drawing, 250A STS2/PDU with left side I-Line distribution

NOTES:

1. ALL DIMENSIONS ARE IN INCHES AND (MILLIMETERS).
2. APPROX. WEIGHT - 3530 LBS. (1601 KG).
3. 18" (457MM) CLEARANCE ABOVE UNIT REQUIRED FOR AIR EXHAUST.
4. INSTALLATION AND SERVICE ACCESS REQUIRED IN FRONT AND LEFT SIDE ONLY.
5. KEEP CABINET WITHIN 15 DEG. OF VERTICAL WHILE HANDLING.
6. COLOR - IBM OFF WHITE.
7. UNIT BOTTOM IS STRUCTURALLY ADEQUATE FOR FORKTRUCK HANDLING.
8. HEAT OUTPUT: APPROX. 12,590 BTU/HR (3.69 KW/HR)
9. THREADED MOUNTING HOLES USED FOR SEISMIC ANCHORING OR FLOOR-STAND. NOTE, IF FLOORSTAND IS USED THE WEIGHT OF THE UNIT MUST BE SUPPORTED UNDER ALL CASTERS.
10. EACH MOUNTING LOCATION IS SUPPORTED BY (2) 10 GA. (1.135") GALVANIZED STEEL. THE THREADED 12MM INSERT IS APPROX. 3/4" DEEP. MOUNTING BOLTS MUST BE THREADED INTO UNIT. MOUNTING HOLES FROM UNDERNEATH UNIT BASE.
11. OPEN DOORS TO REPLACE AIR FILTER. DISPOSABLE TYPE SIZE 1 X 25 X 25.
12. TOP AND BOTTOM CABLE ENTRY AVAILABLE THROUGH REMOVABLE ACCESS PLATES. REMOVE, PUNCH TO SUIT CONDUIT SIZE AND REPLACE.



| | | | |
|---|--|--|--|
| <p>OUTLINE DRAWING 250 AMP LEFT SIDE MOUNTED I-LINE DISTRIBUTION STS2/PDU</p> | | <p>DWG. NO. PSP11202</p> | |
| | | <p>REV. NO. DATE 12/18/03</p> | |
| <p>DRAWN BY V.CARMONA</p> | | <p>EMERSON</p> | |
| <p>CHK BY</p> | | <p>1050 DEARBORN DRIVE, COLUMBUS, OHIO 43229</p> | |
| <p>REF. DWG.</p> | | <p>FILE NAME: I582-PDU/OUTLINE/PSP11202</p> | |

Figure 11 Outline drawing, 250A STS2/PDU with left side Inline distribution

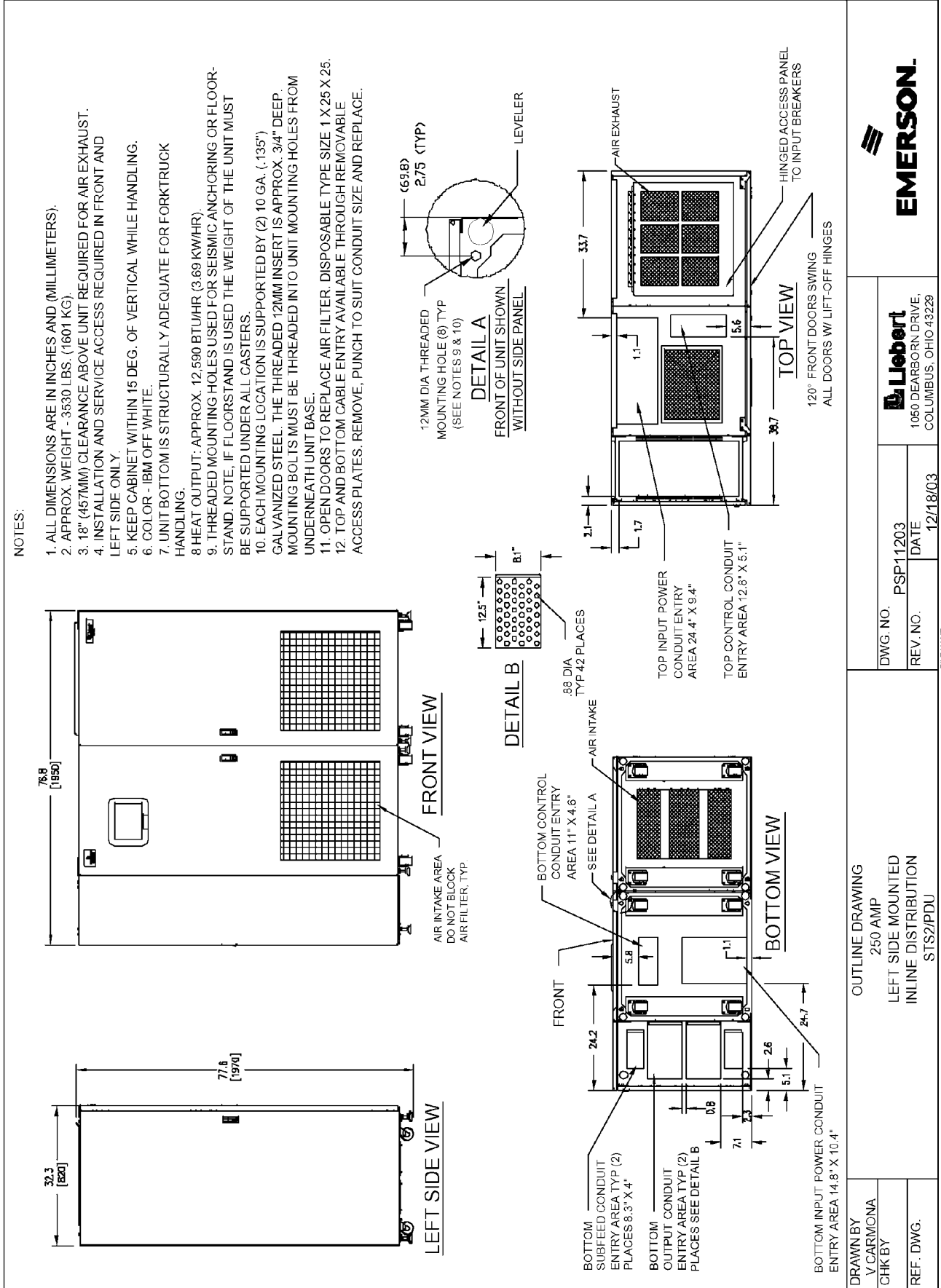

Figure 12 Outline drawing, 400-600A STS2/PDU with right side inline distribution

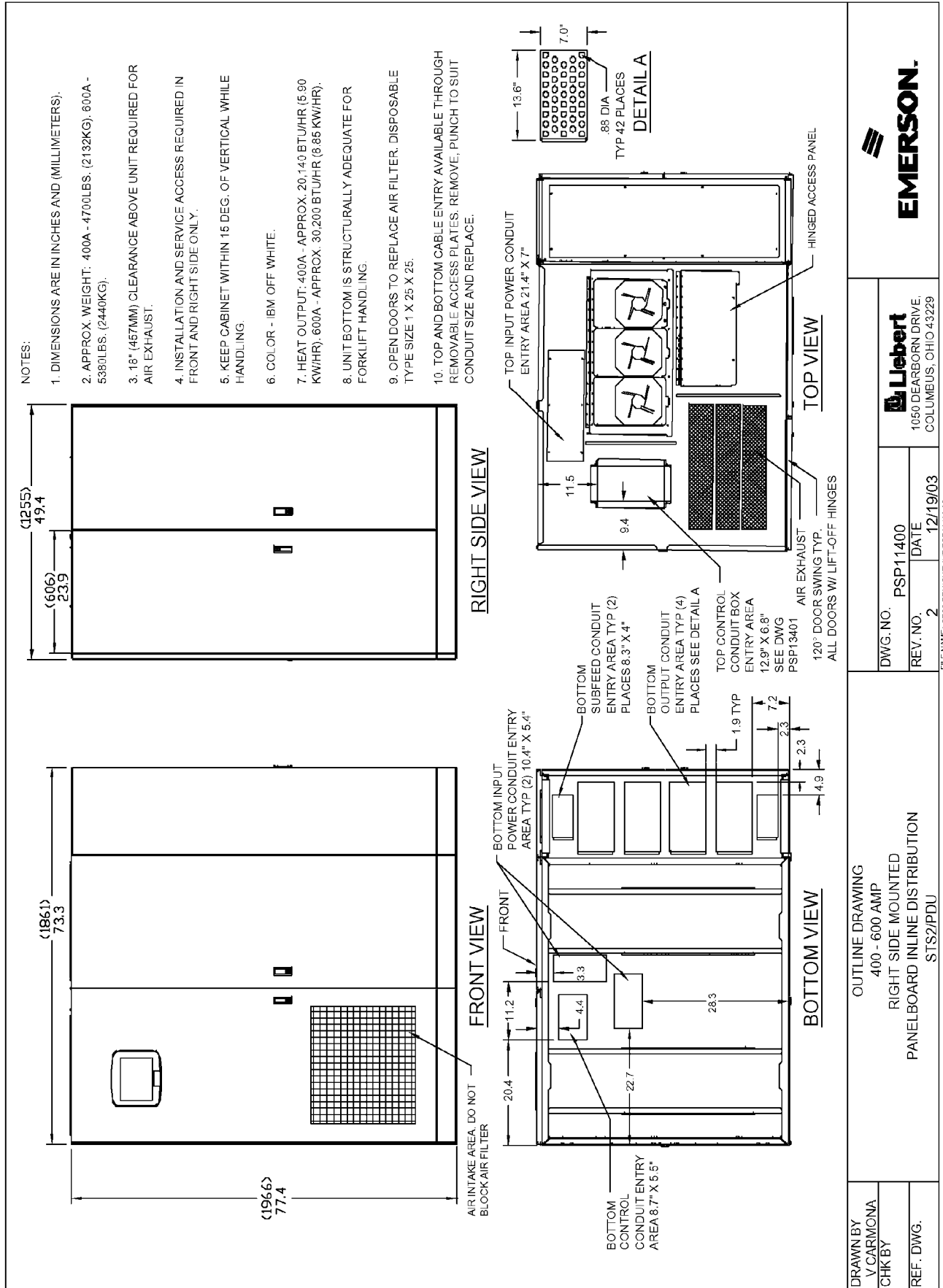

Figure 13 Outline drawing, 400-600A STS2/PDU with right side output breaker or I-Line distribution

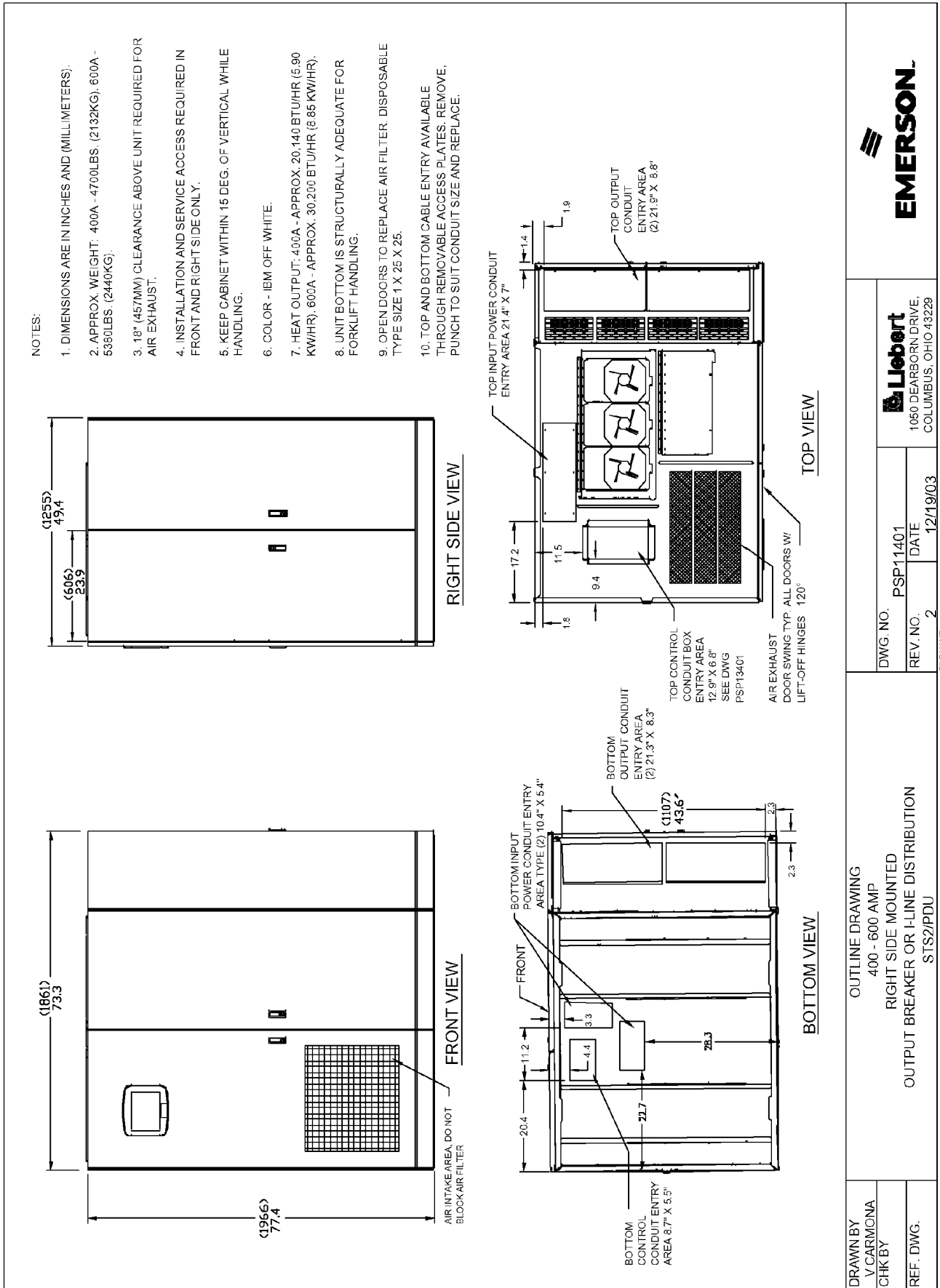

Figure 14 Outline drawing, 400-600A STS2/PDU with left side inline distribution

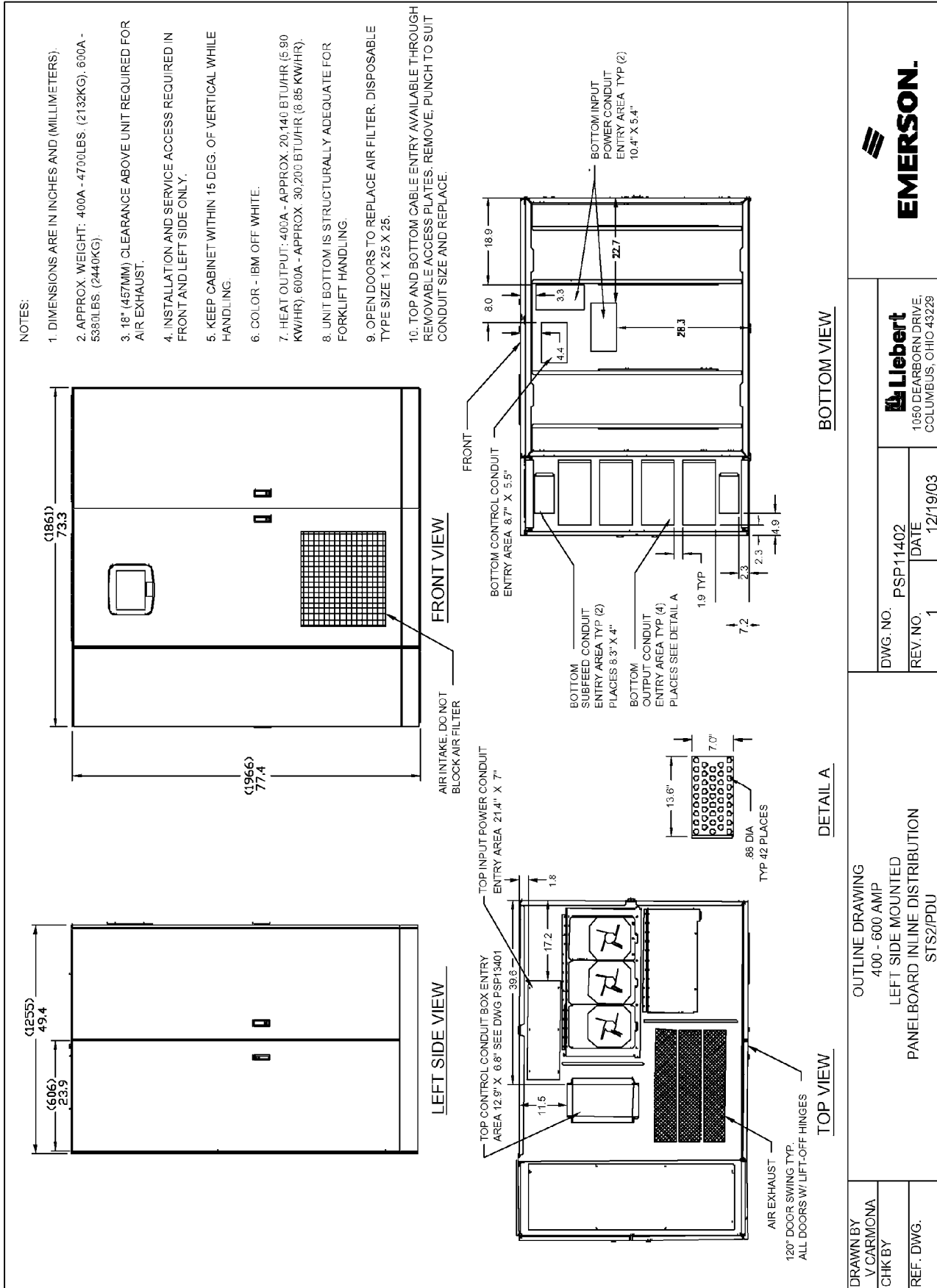

Figure 15 Outline drawing, 400-600A STS2/PDU with left side output breaker or I-Line distribution

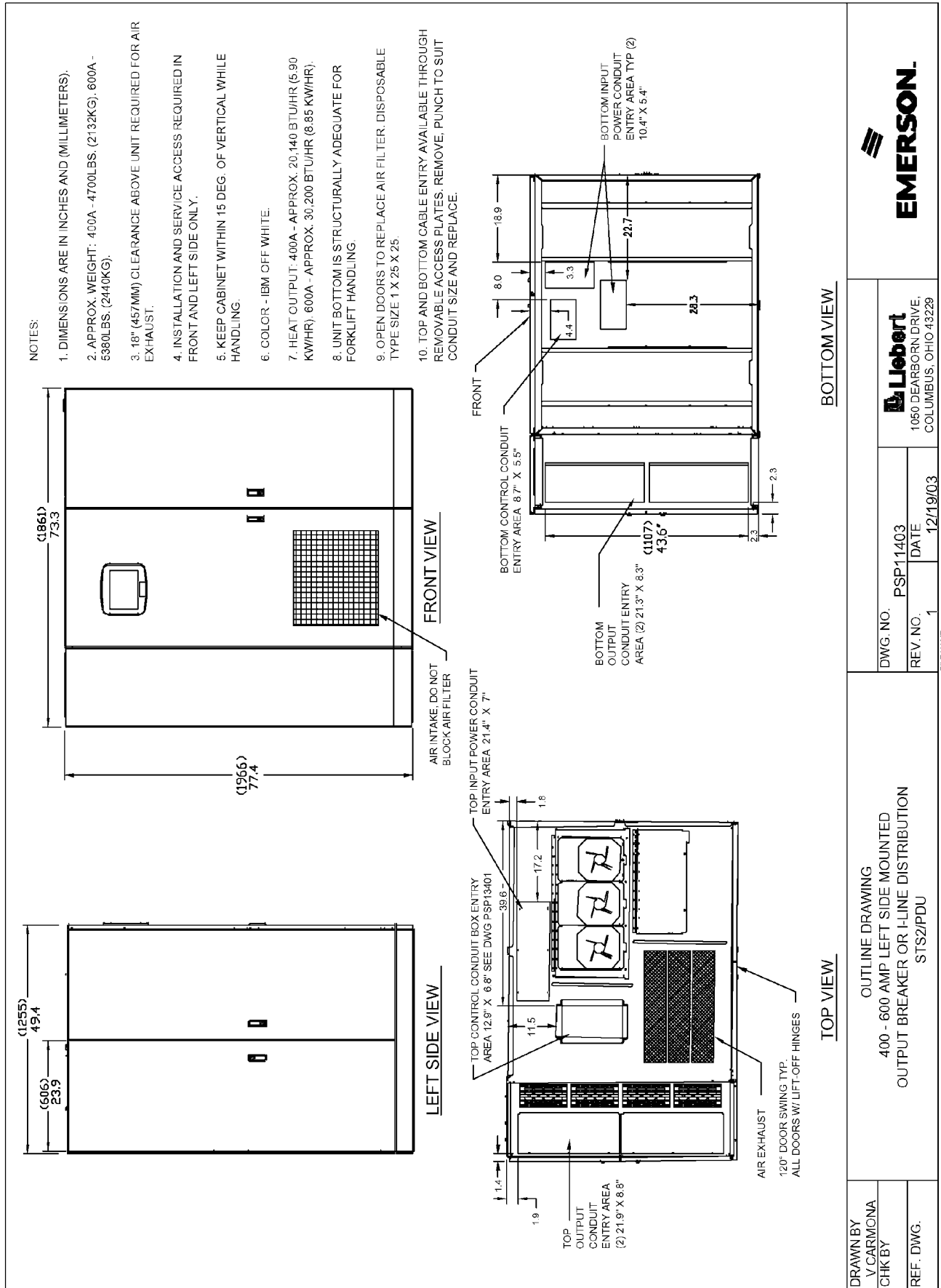

Figure 16 Outline drawing, 800A STS2/PDU with right side output breaker or I-Line distribution

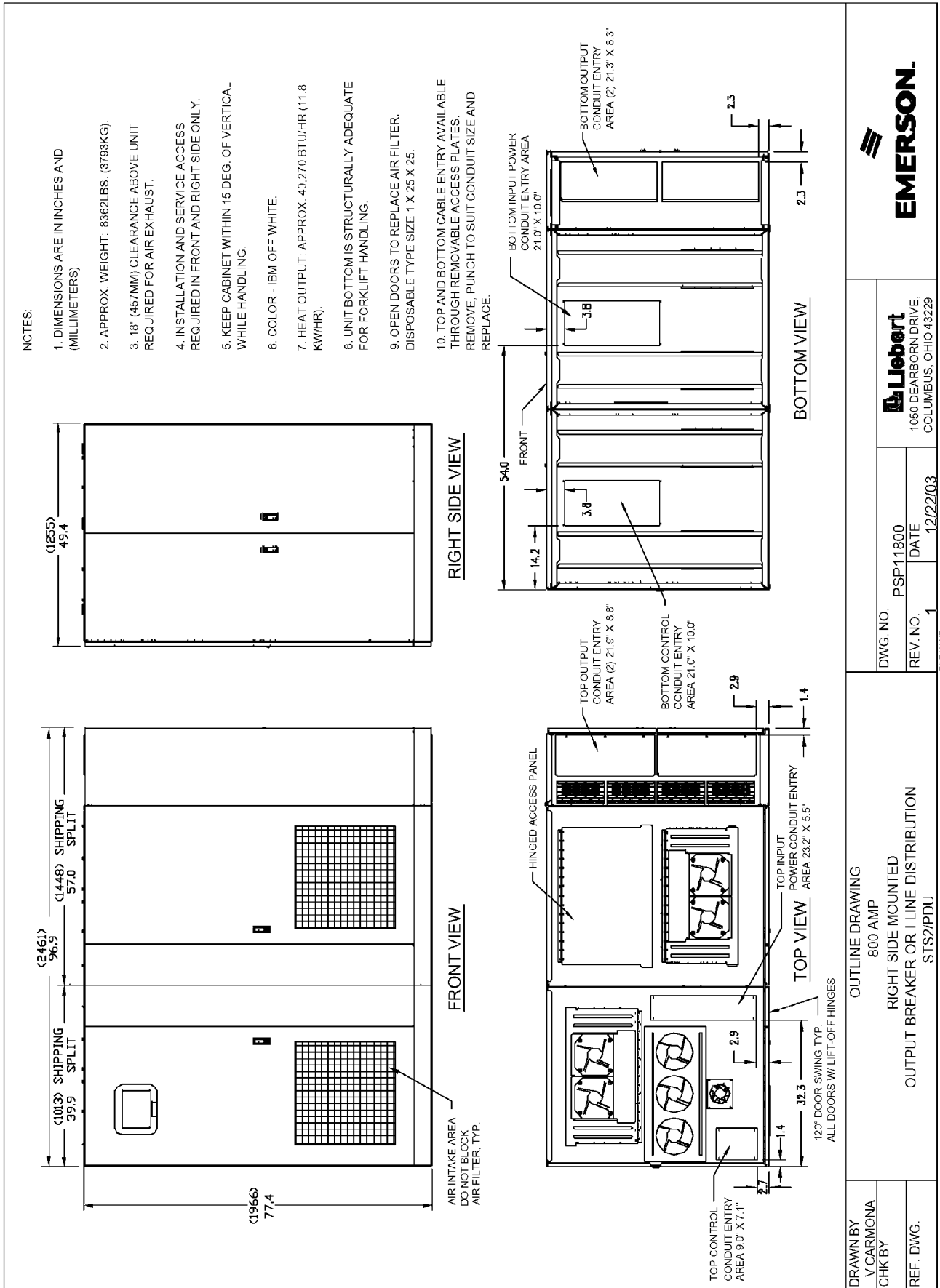

Figure 18 Outline drawing, 800A STS2/PDU with left side output breaker or I-Line distribution

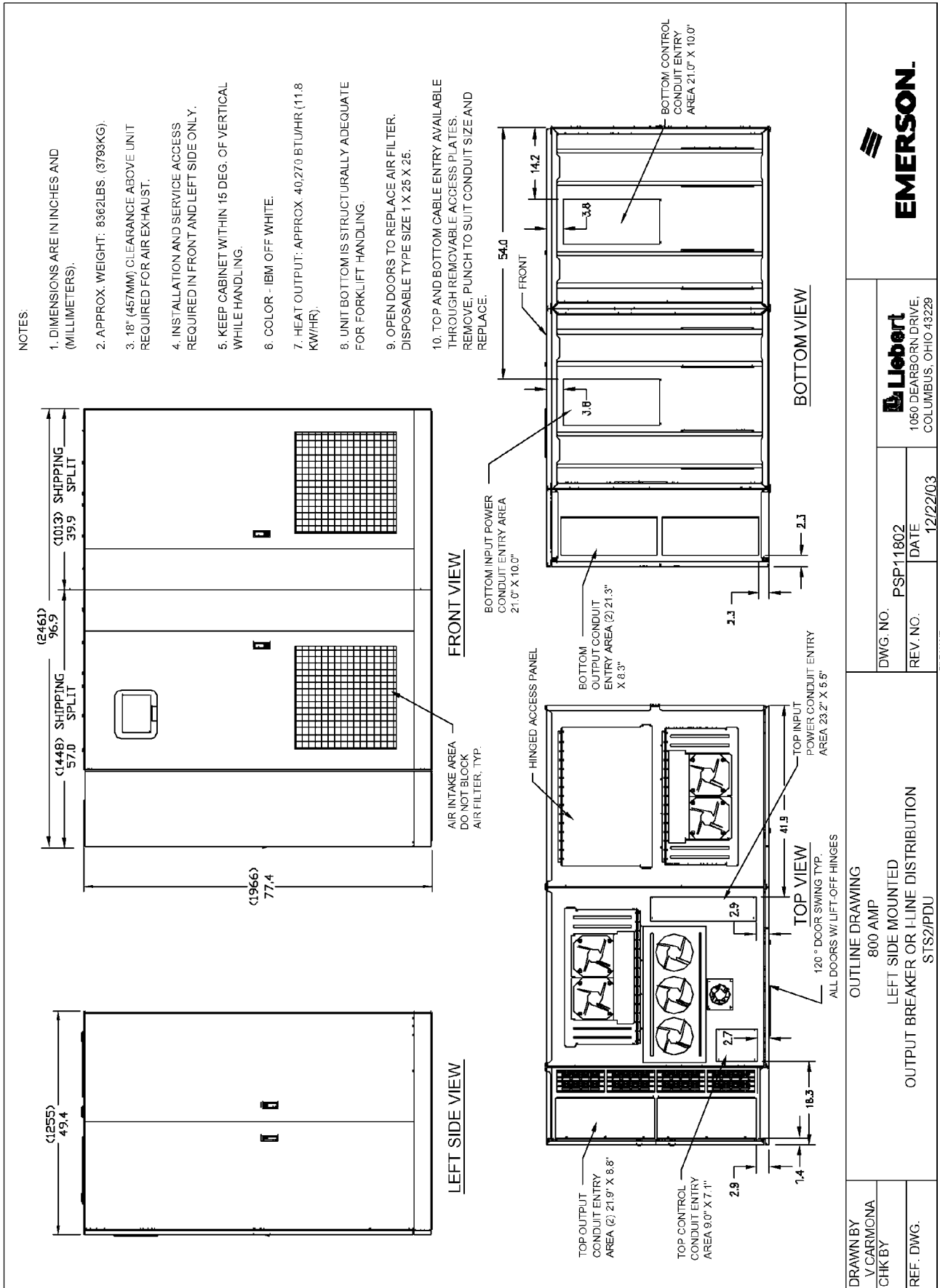

Figure 19 Outline drawing, 800A STS2/PDU with left side inline distribution

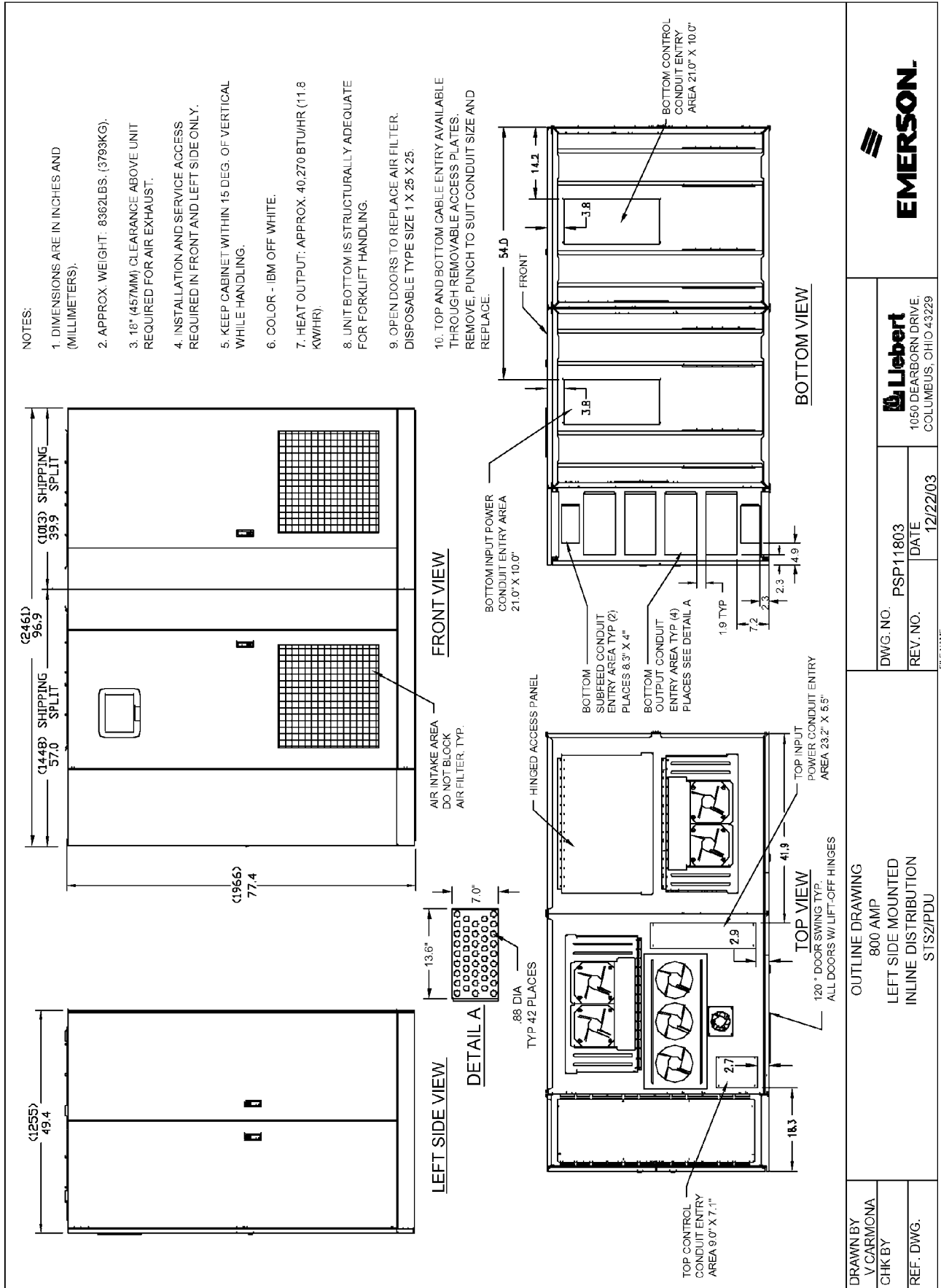
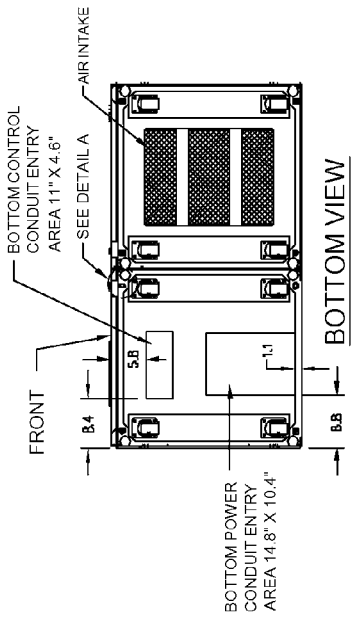
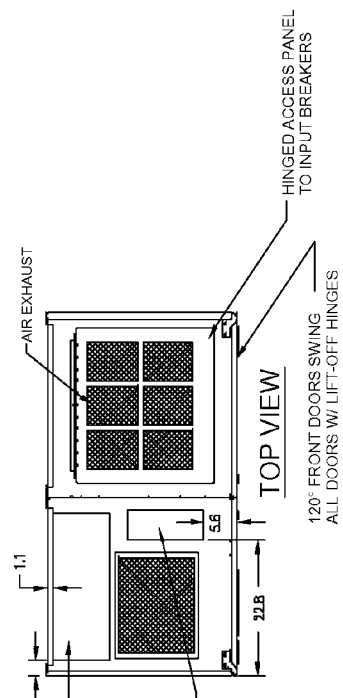
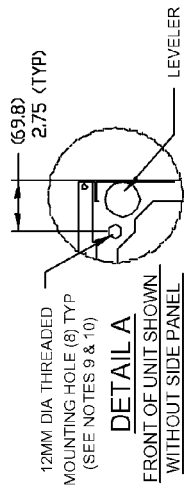
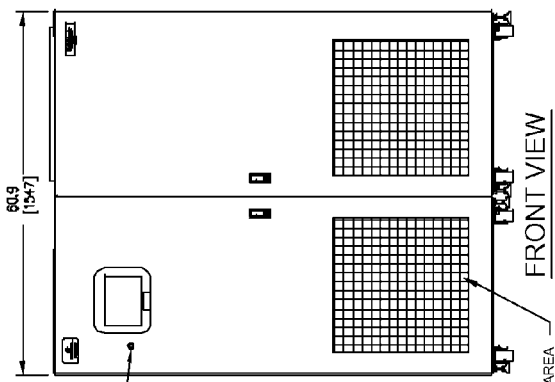
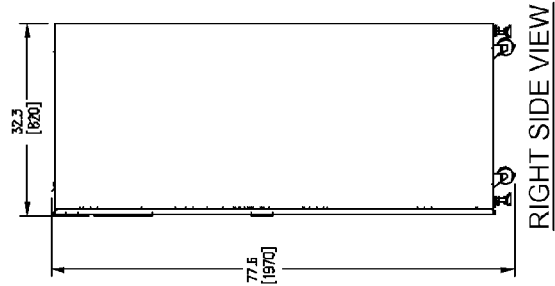

Figure 20 Outline drawing, 250A STS2/PDU with key lockout switch option

NOTES:

1. ALL DIMENSIONS ARE IN INCHES AND (MILLIMETERS).
2. APPROX. WEIGHT - 3,310 LBS. (1510 KG).
3. 18" (457MM) CLEARANCE ABOVE UNIT REQUIRED FOR AIR EXHAUST.
4. INSTALLATION AND SERVICE ACCESS REQUIRED IN FRONT.
5. KEEP CABINET WITHIN 15 DEG. OF VERTICAL WHILE HANDLING.
6. COLOR - IBM OFF WHITE.
7. UNIT BOTTOM IS STRUCTURALLY ADEQUATE FOR FORKTRUCK HANDLING.
8. HEAT OUTPUT: APPROX. 12,590 BTU/HR (3.69 KW/HR).
9. THREADED MOUNTING HOLES USED FOR SEISMIC ANCHORING OR FLOORSTAND. NOTE, IF FLOORSTAND IS USED THE WEIGHT OF THE UNIT MUST BE SUPPORTED UNDER ALL CASTERS.
10. EACH MOUNTING LOCATION IS SUPPORTED BY (2) 10 GA. (.135") GALVANIZED STEEL. THE THREADED 12MM INSERT IS APPROX. 3/4" DEEP. MOUNTING BOLTS MUST BE THREADED INTO UNIT MOUNTING HOLES FROM UNDERNEATH UNIT BASE.
11. OPEN DOORS TO REPLACE AIR FILTER. DISPOSABLE TYPE SIZE 1 X 25 X 25.
12. TOP AND BOTTOM CABLE ENTRY AVAILABLE THROUGH REMOVABLE ACCESS PLATES. REMOVE, PUNCH TO SUIT CONDUIT SIZE AND REPLACE.



Liobert
1050 DEARBORN DRIVE,
COLUMBUS, OHIO 43229

DWG. NO. PSP-11201
REV. NO. DATE 12/18/03
FILE NAME: STS2-PDU-OUTLINE.PSP1201

OUTLINE DRAWING
250 AMP
WITH KEY LOCKOUT SWITCH
STS2/PDU

DRAWN BY V. CARMONA
CHK BY
REF. DWG.

Figure 21 Outline drawing, 400-600A STS2/PDU, inline distribution, right side with key lockout switch option

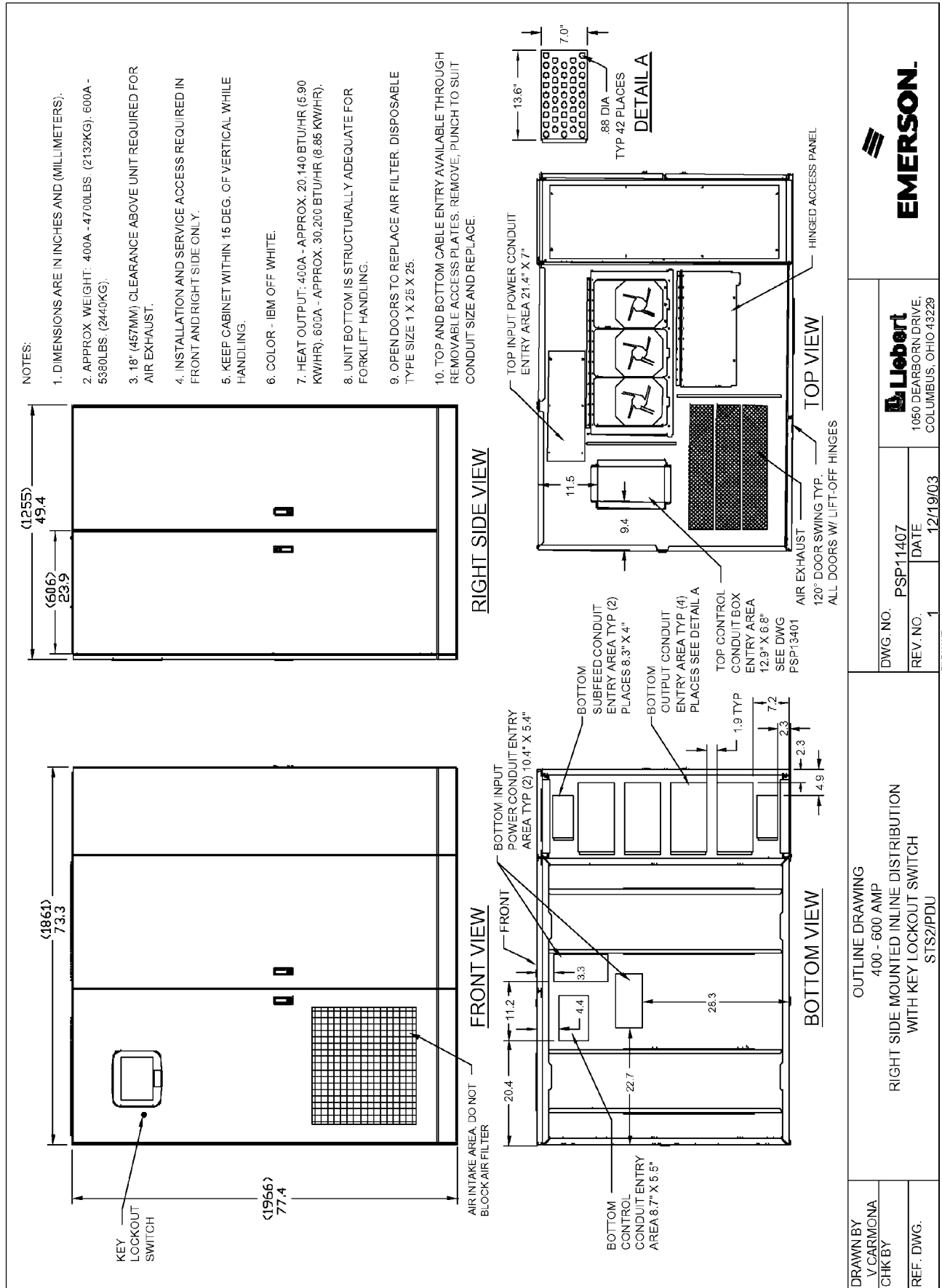
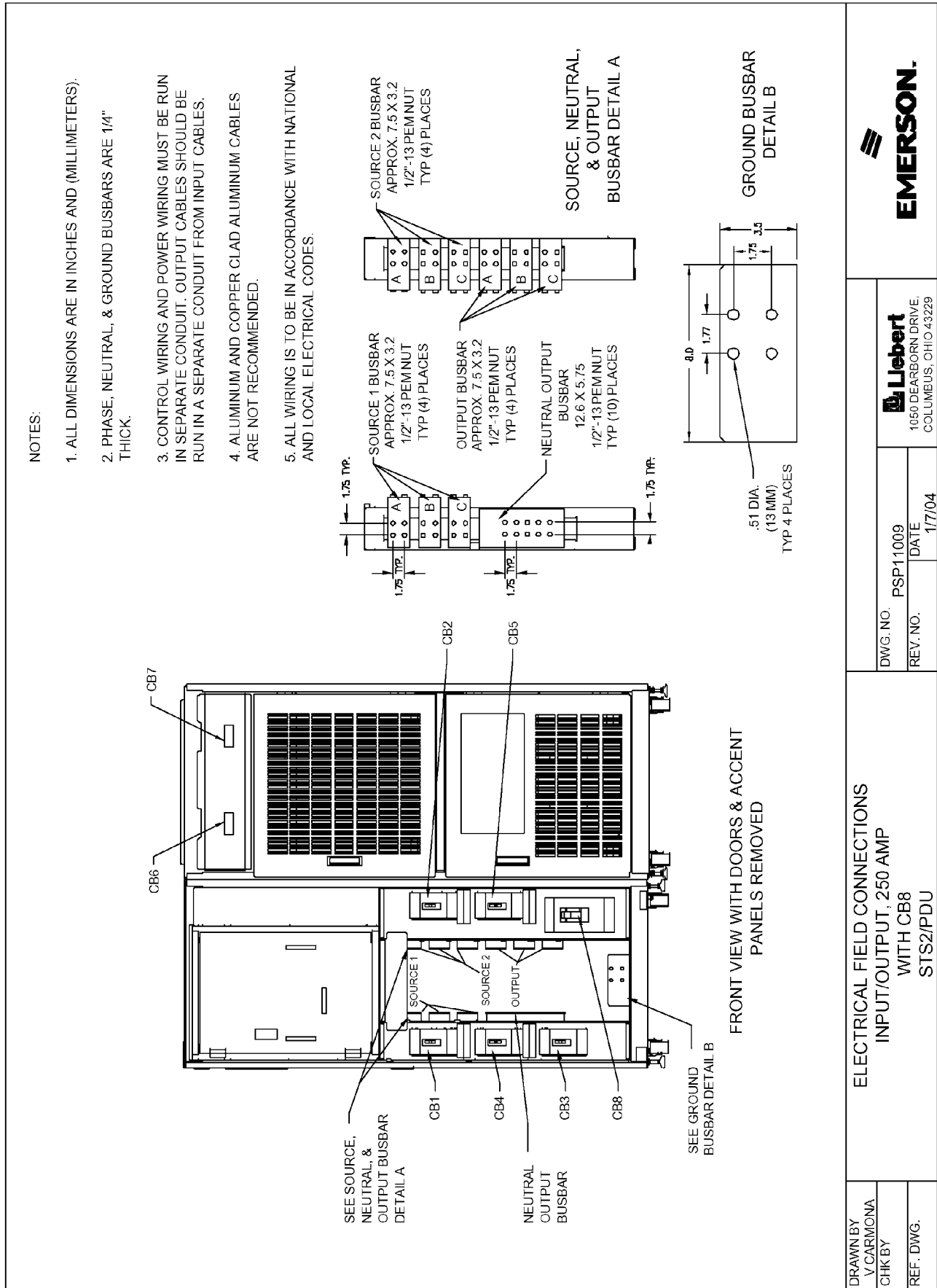

Figure 23 Electrical field connections, 250A STS2/PDU input/output with CB8



DRAWN BY
V.CARMONA

CHK BY

REF. DWG.

ELECTRICAL FIELD CONNECTIONS
INPUT/OUTPUT, 250 AMP
WITH CB8
STS2/PDU

DWG. NO. PSP11009

REV. NO. DATE 1/7/04

FILE NAME: STS/PDU/EF/CPSP11009



Figure 24 Electrical field connections, 250A STS2/PDU input with CB3

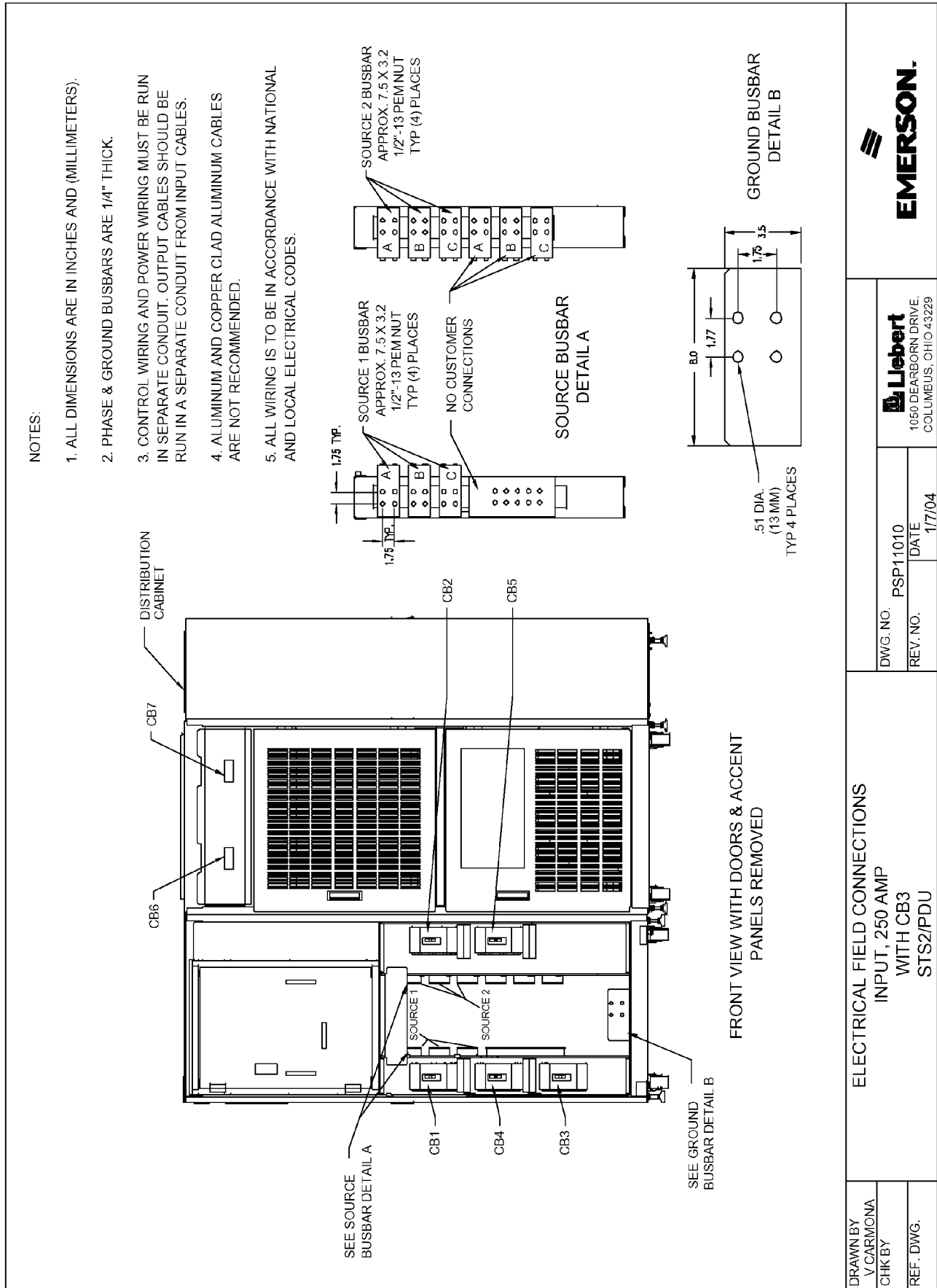

EMERSON.

Lebert
1050 DEARBORN DRIVE,
COLUMBUS, OHIO 43229

DWG. NO. PSP11010
REV. NO. DATE 1/7/04
FILE NAME: STS/PDU/FC/PS11010

ELECTRICAL FIELD CONNECTIONS
INPUT, 250 AMP
WITH CB3
STS2/IPDU

DRAWN BY V.CARMONA
CHK BY
REF. DWG.

Figure 25 Electrical field connections, 250A STS2/PDU input with CB3 & CB3A

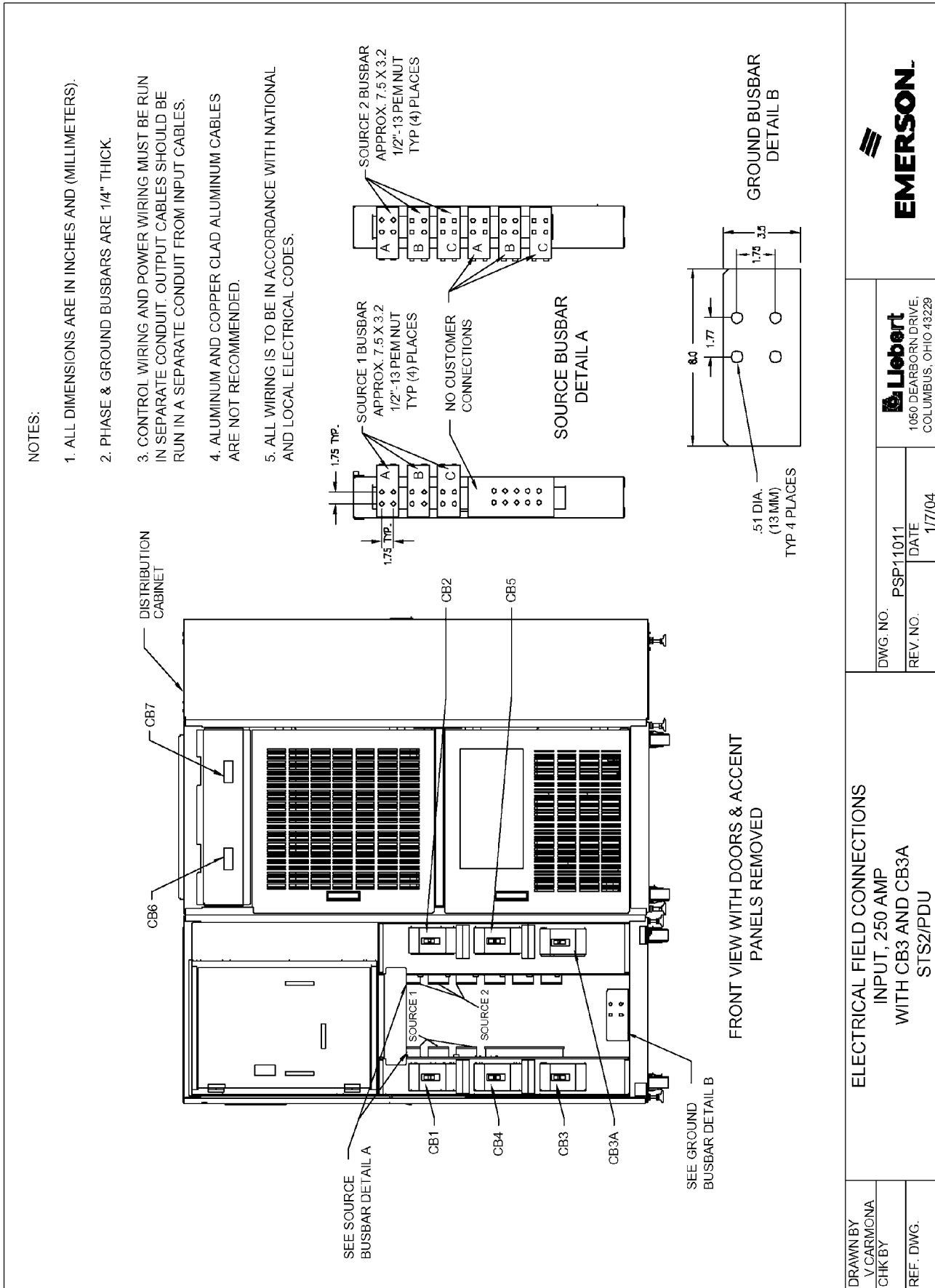

Figure 26 Electrical field connections, 400-600A STS2/PDU input with CB3

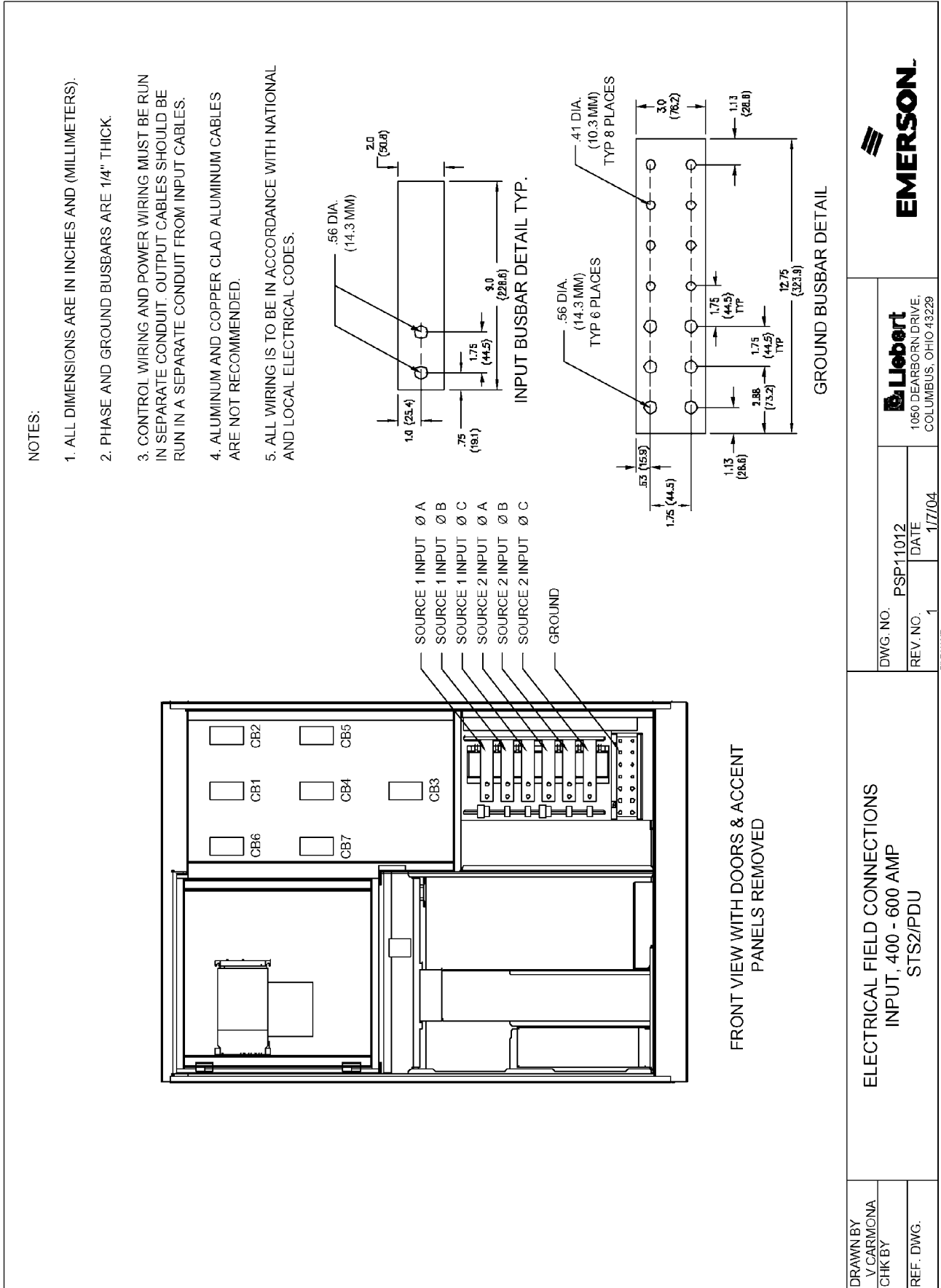

Figure 27 Electrical field connections, 400-600A STS2/PDU input with CB3 and CB3A

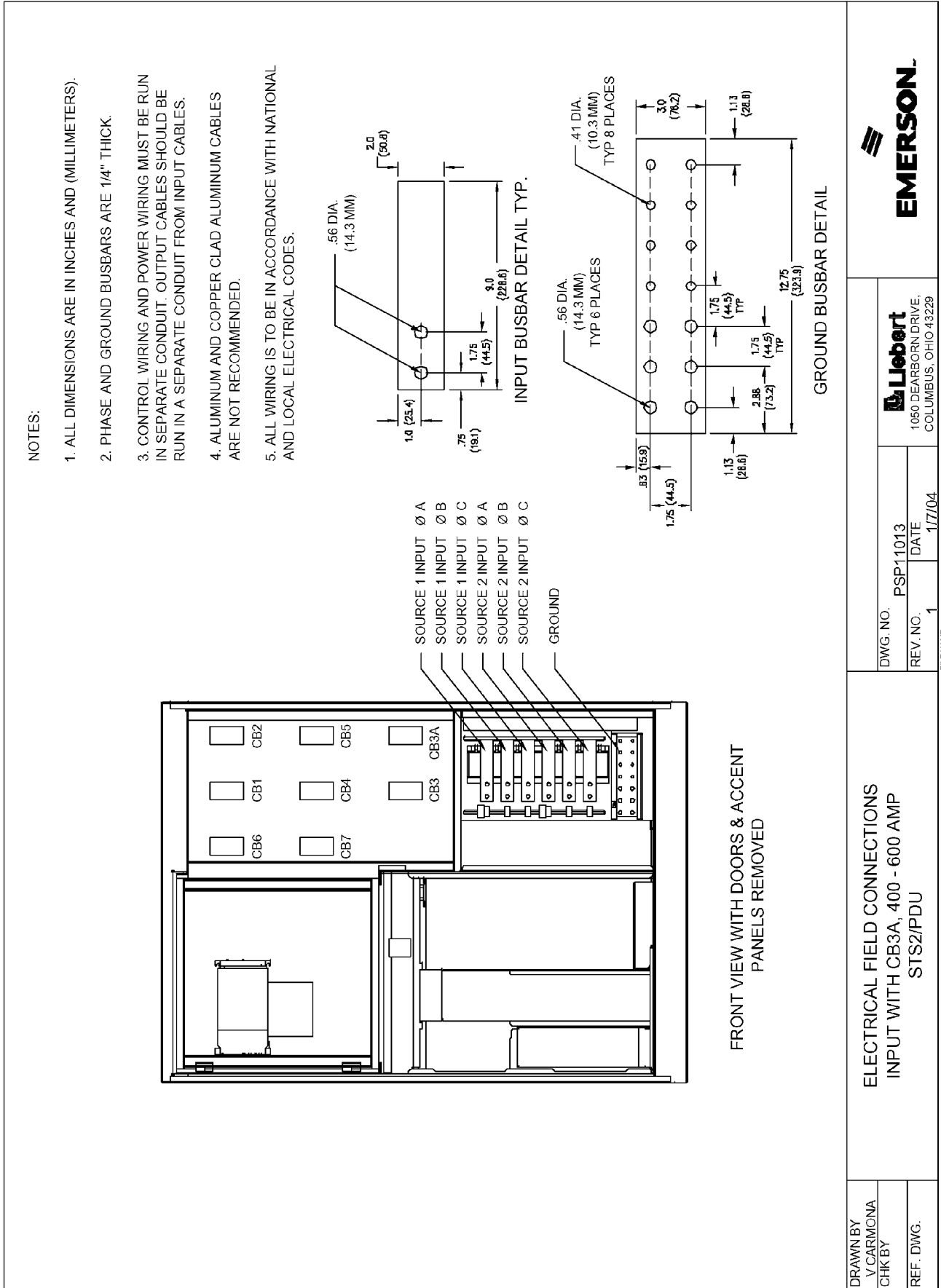

Figure 29 Electrical field connections, 800A STS2/PDU input with CB3 and CB3A

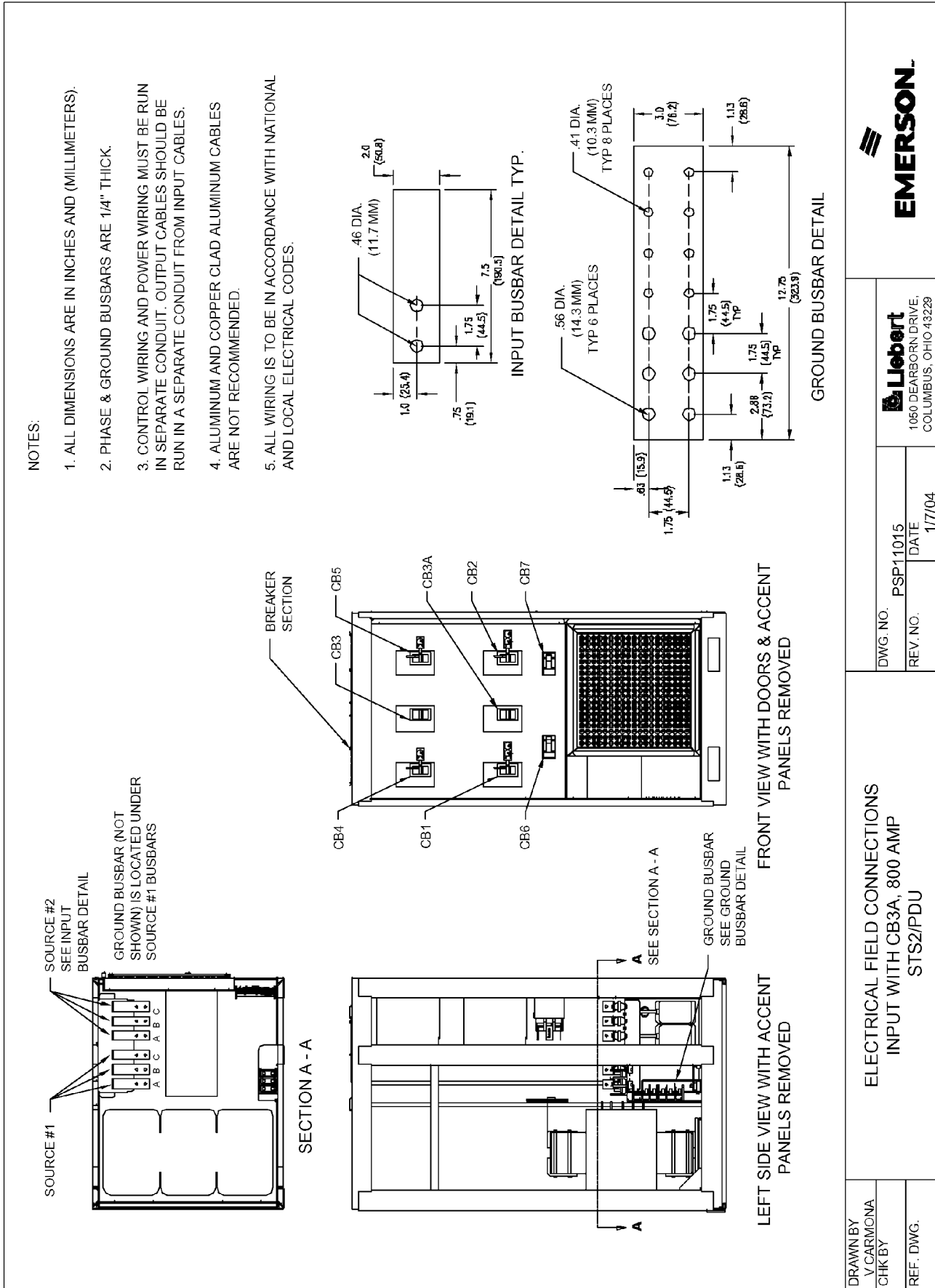
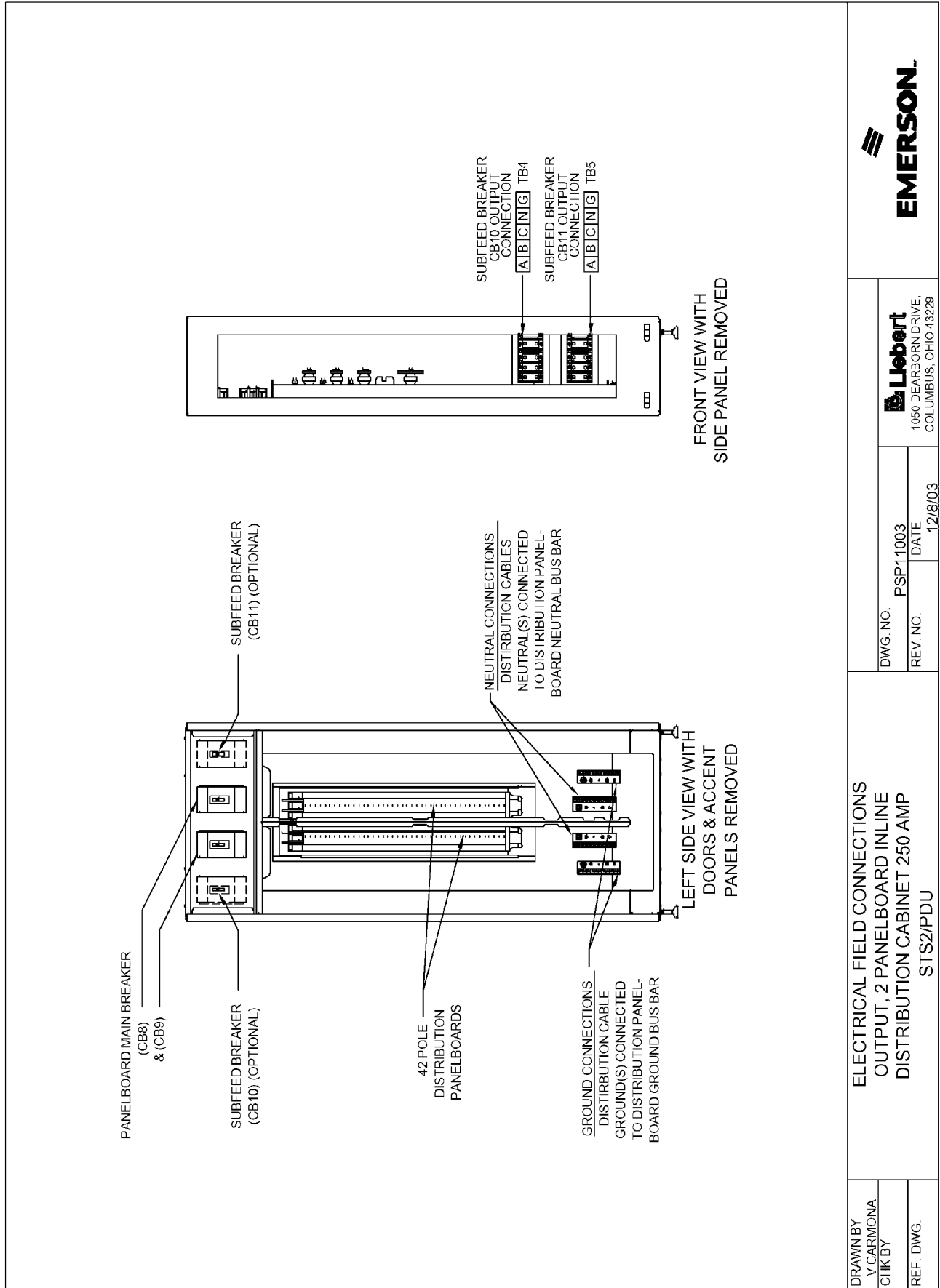

Figure 30 Electrical field connections, 250A STS2/PDU output with inline panelboards



Liabert
 1050 DEARBORN DRIVE,
 COLUMBUS, OHIO 43229

DWG. NO. PSP11003
 REV. NO. DATE 12/8/03
 FILE NAME: /STS2/PDU/FCSPSP11003

**ELECTRICAL FIELD CONNECTIONS
 OUTPUT, 2 PANELBOARD INLINE
 DISTRIBUTION CABINET 250 AMP
 STS2/PDU**

DRAWN BY V. CARMONA
 CHK BY
 REF. DWG.

Figure 31 Electrical field connections, 400-800A STS2/PDU output with inline panelboards

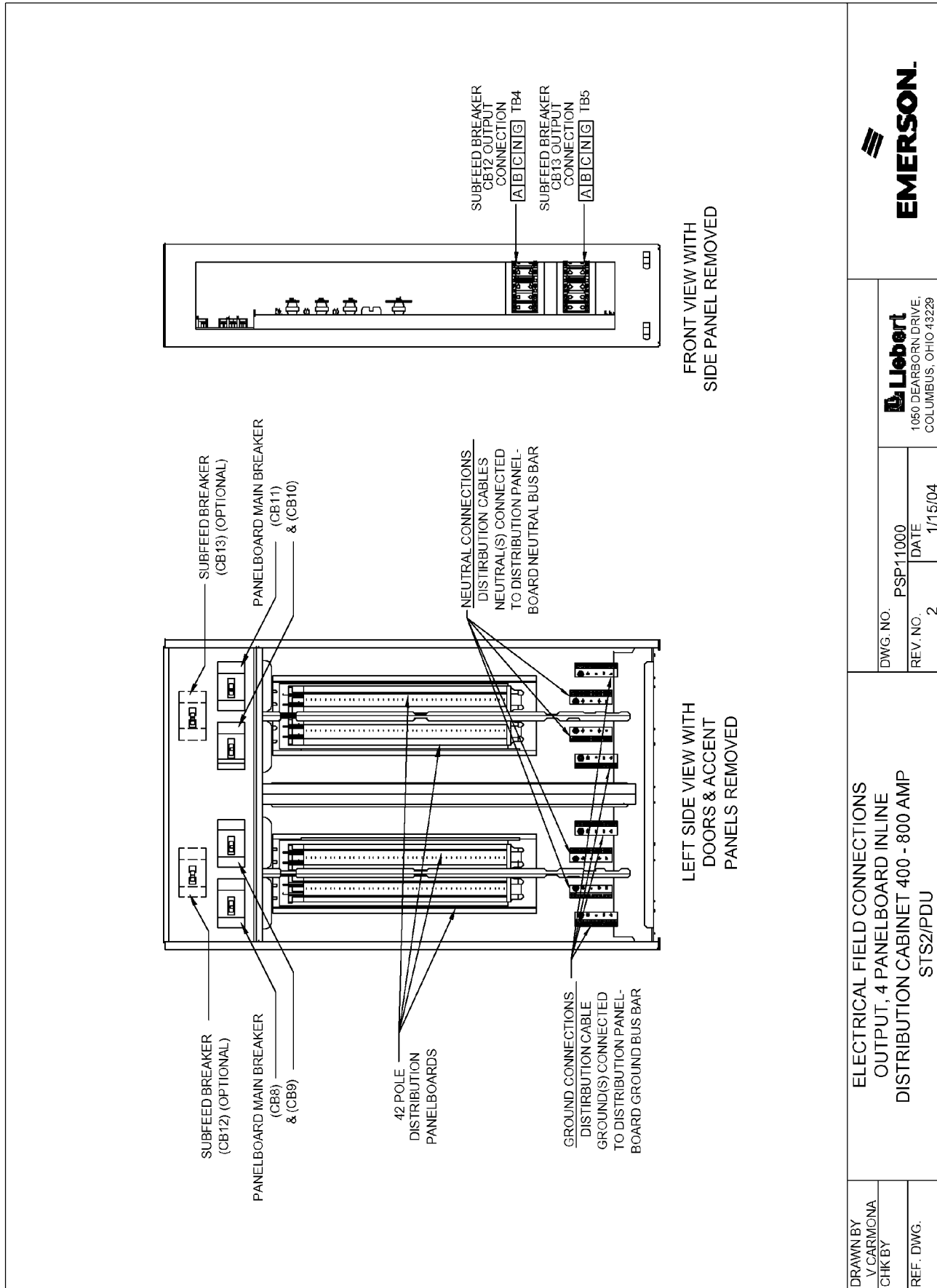

1050 DEARBORN DRIVE,
COLUMBUS, OHIO 43229

DWG. NO. PSP11000

REV. NO. 2 DATE 1/15/04

FILE NAME: 152-PDU/CF/SP11000-02

ELECTRICAL FIELD CONNECTIONS
OUTPUT, 4 PANELBOARD INLINE
DISTRIBUTION CABINET 400 - 800 AMP
STS2/PDU

DRAWN BY V.CARMONA

CHK BY

REF. DWG.

Figure 32 Electrical field connections, STS2/PDU output with I-Line panelboard

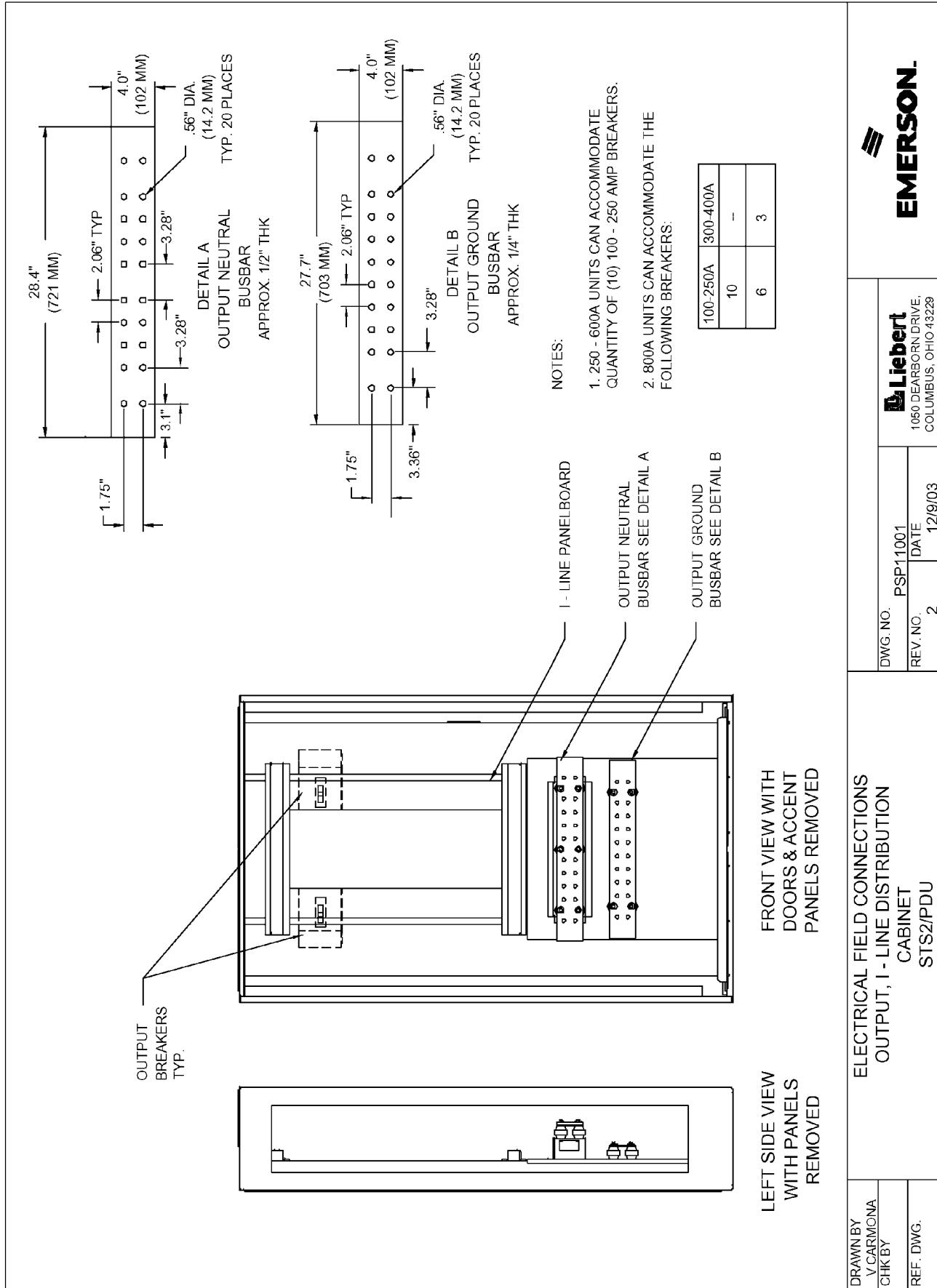

Figure 33 Electrical field connections, 400-600A STS2/PDU with right side output breaker

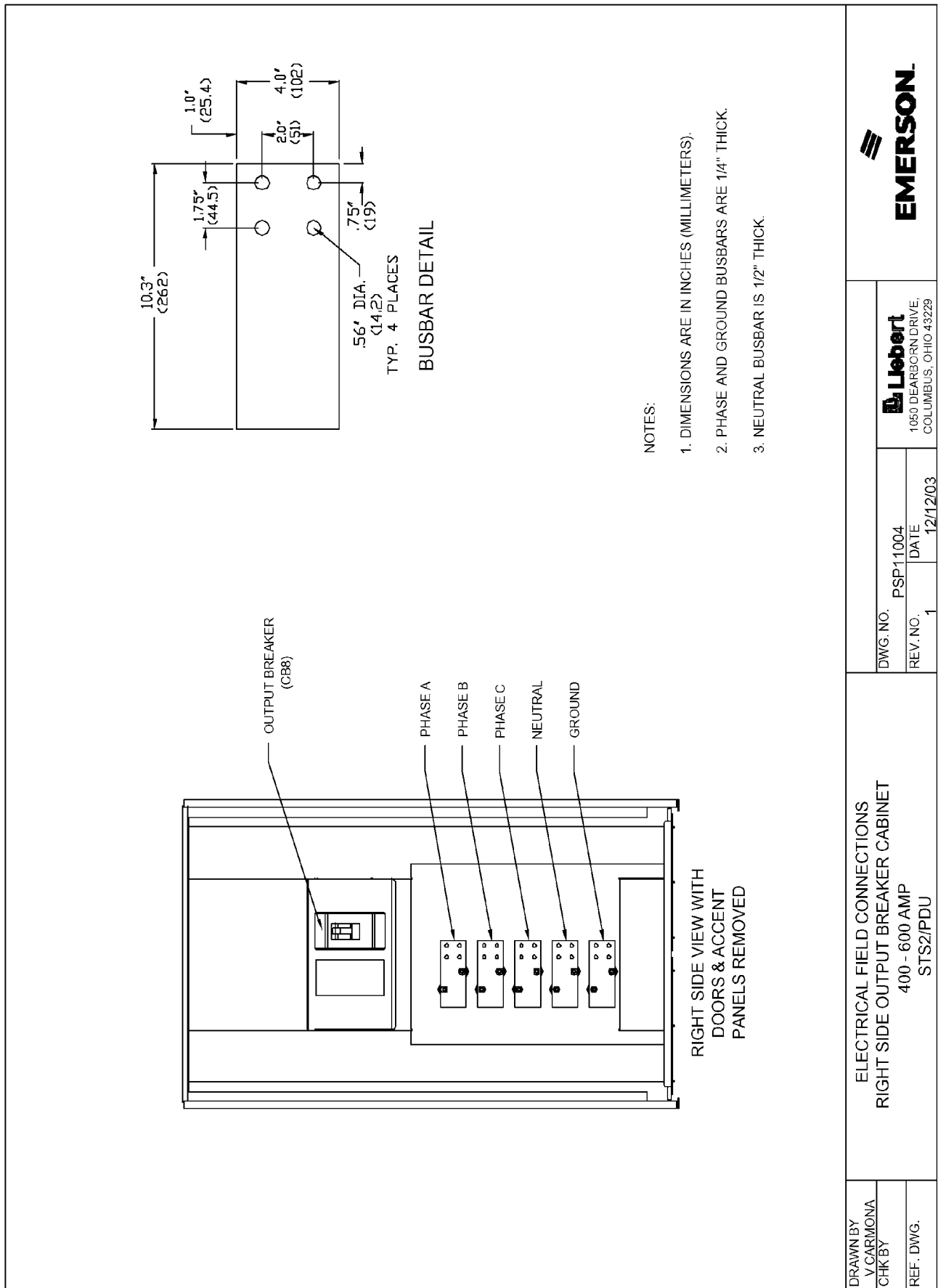

Figure 34 Electrical field connections, 400-600A STS2/PDU with left side output breaker

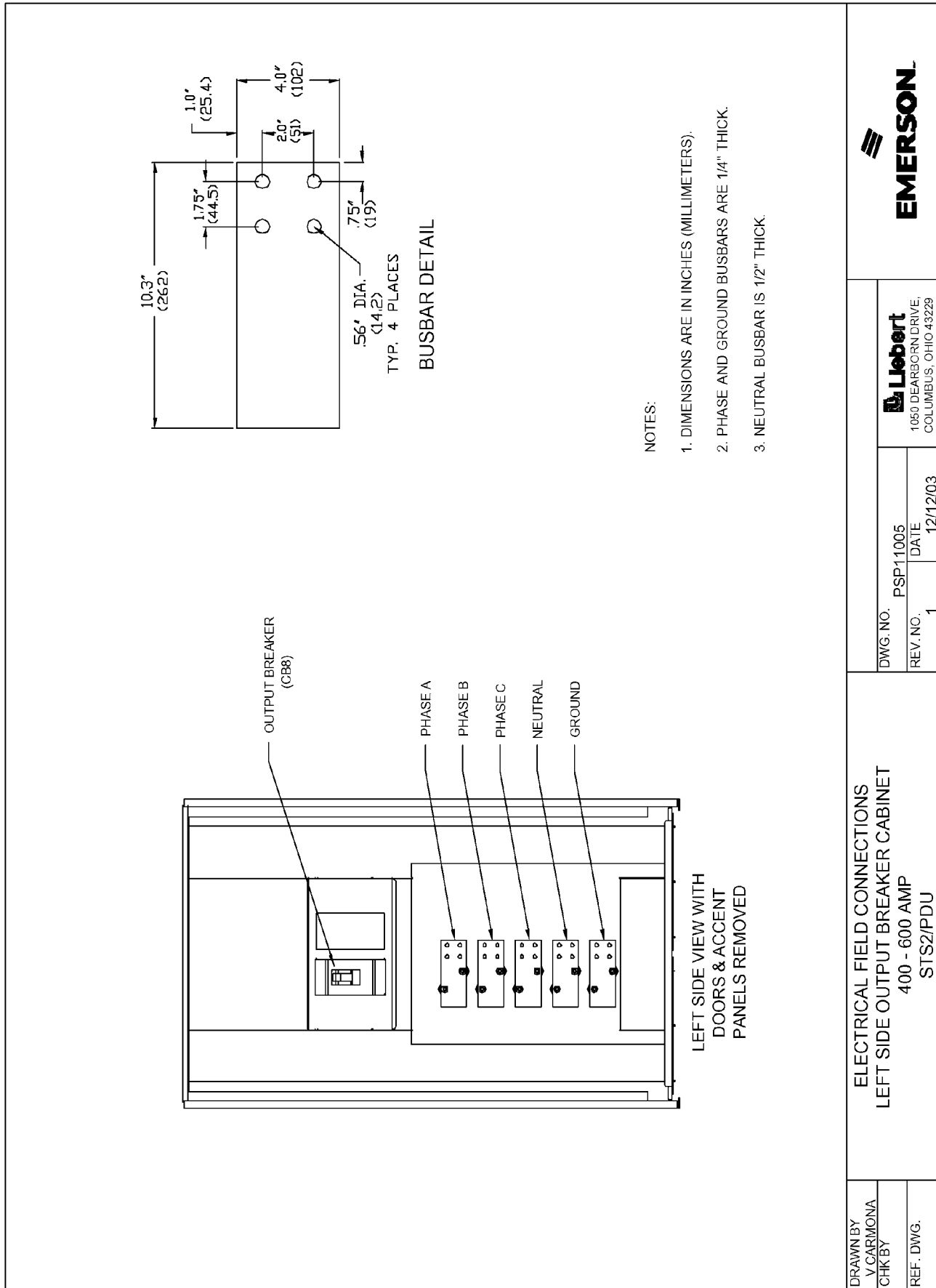
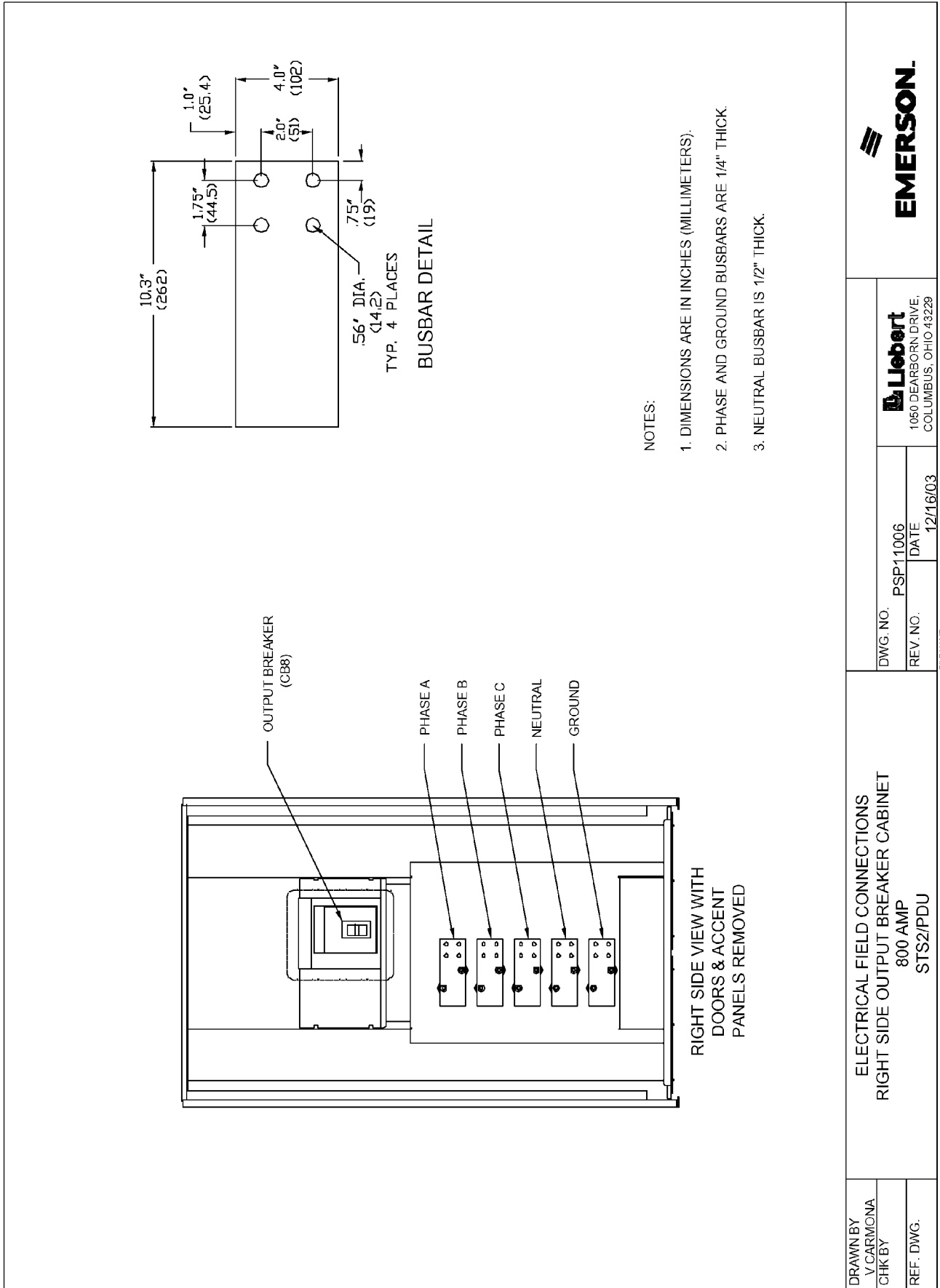

Figure 35 Electrical field connections, 800A STS2/PDU with right side output breaker



| | | | |
|-----------------------|--|---------------|---|
| DRAWN BY V.CARMONA | DWG. NO. PSP11006 | |  EMERSON. |
| | CHK BY | DATE 12/16/03 | |
| REF. DWG. | ELECTRICAL FIELD CONNECTIONS RIGHT SIDE OUTPUT BREAKER CABINET 800 AMP STS2/PDU | | FILE NAME: STS2-PDU-FC-PSP11006 |

Figure 36 Electrical field connections, 8600A STS2/PDU with left side output breaker

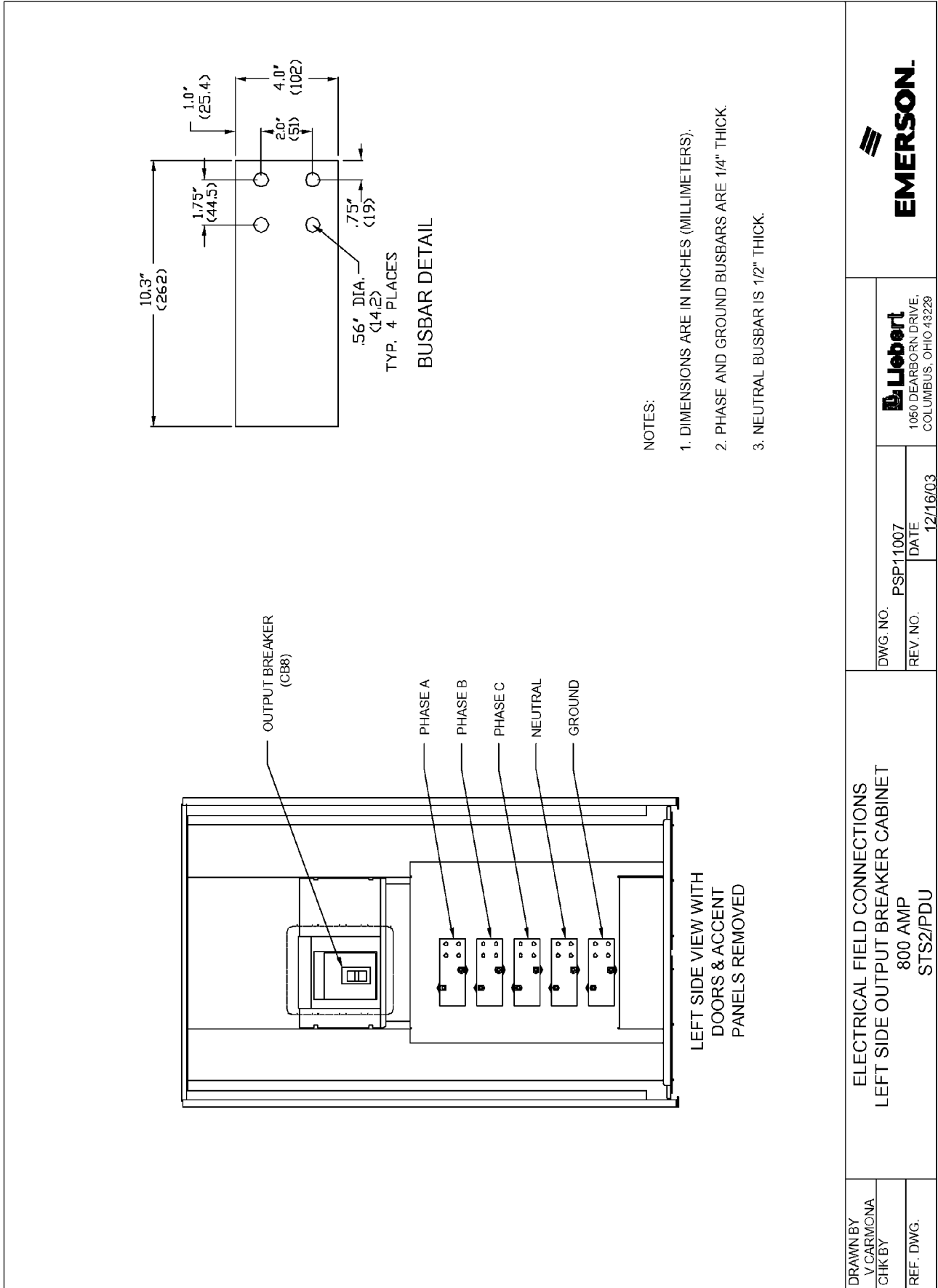
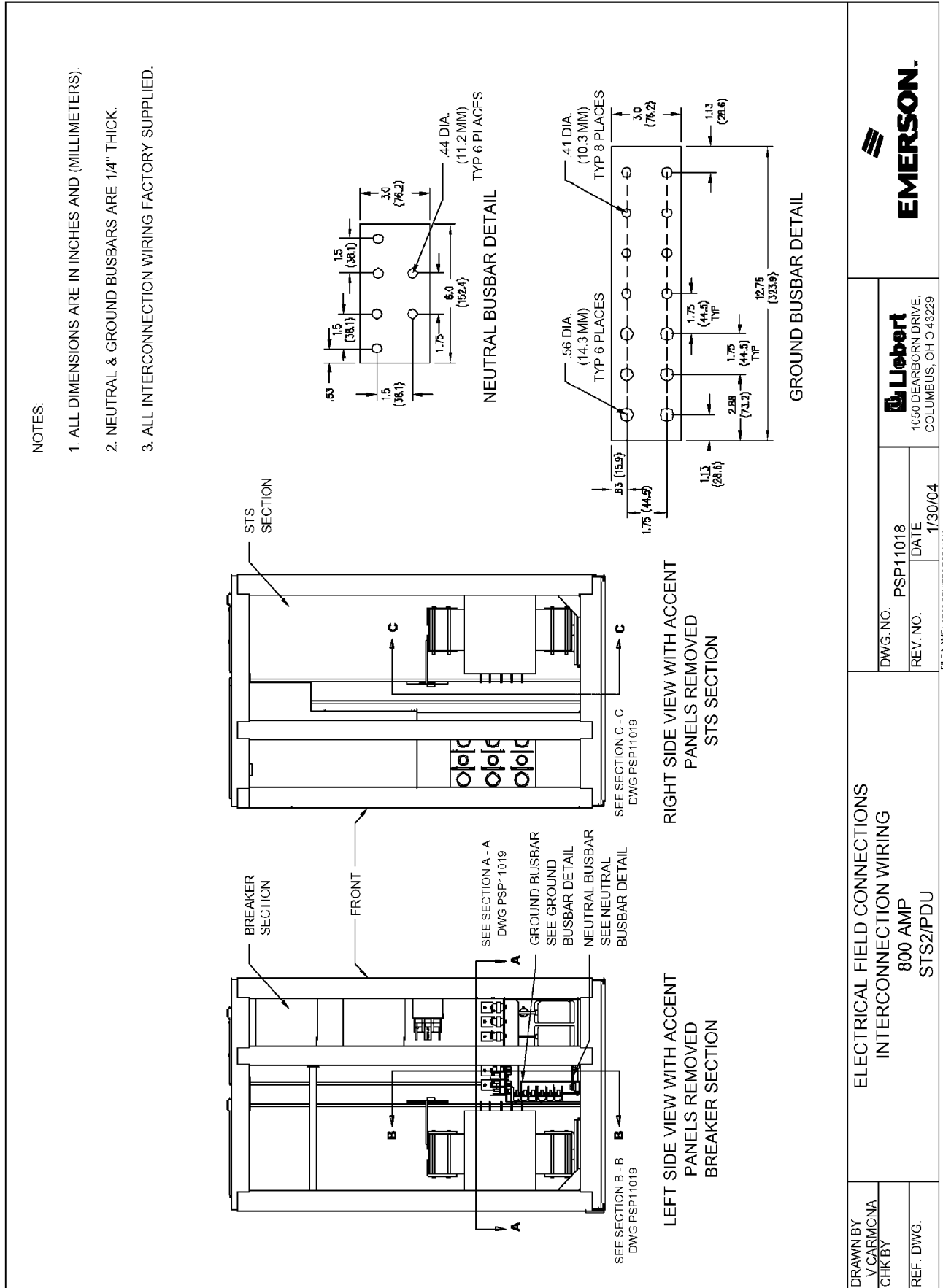

Figure 37 Electrical field connections, 800A STS2/PDU interconnect wiring



DRAWN BY
V.CARMONA
CHK BY
REF. DWG.

ELECTRICAL FIELD CONNECTIONS
INTERCONNECTION WIRING
800 AMP
STS2/PDU

DWG. NO. PSP11018
REV. NO. DATE
1/30/04

Lebert
1050 DEARBORN DRIVE,
COLUMBUS, OHIO 43229



Figure 38 Electrical field connections, 800A STS2/PDU interconnect wiring, breaker section

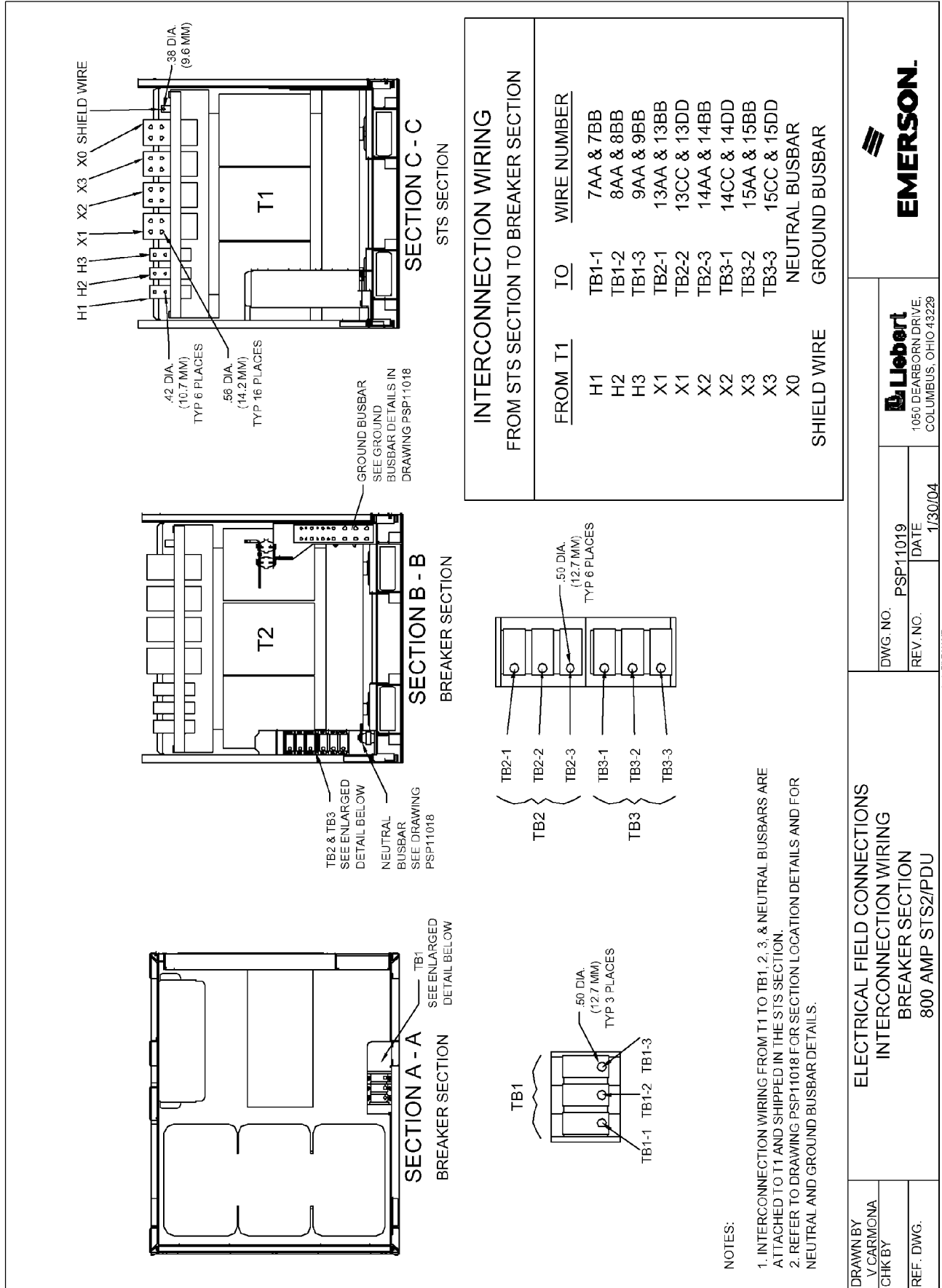
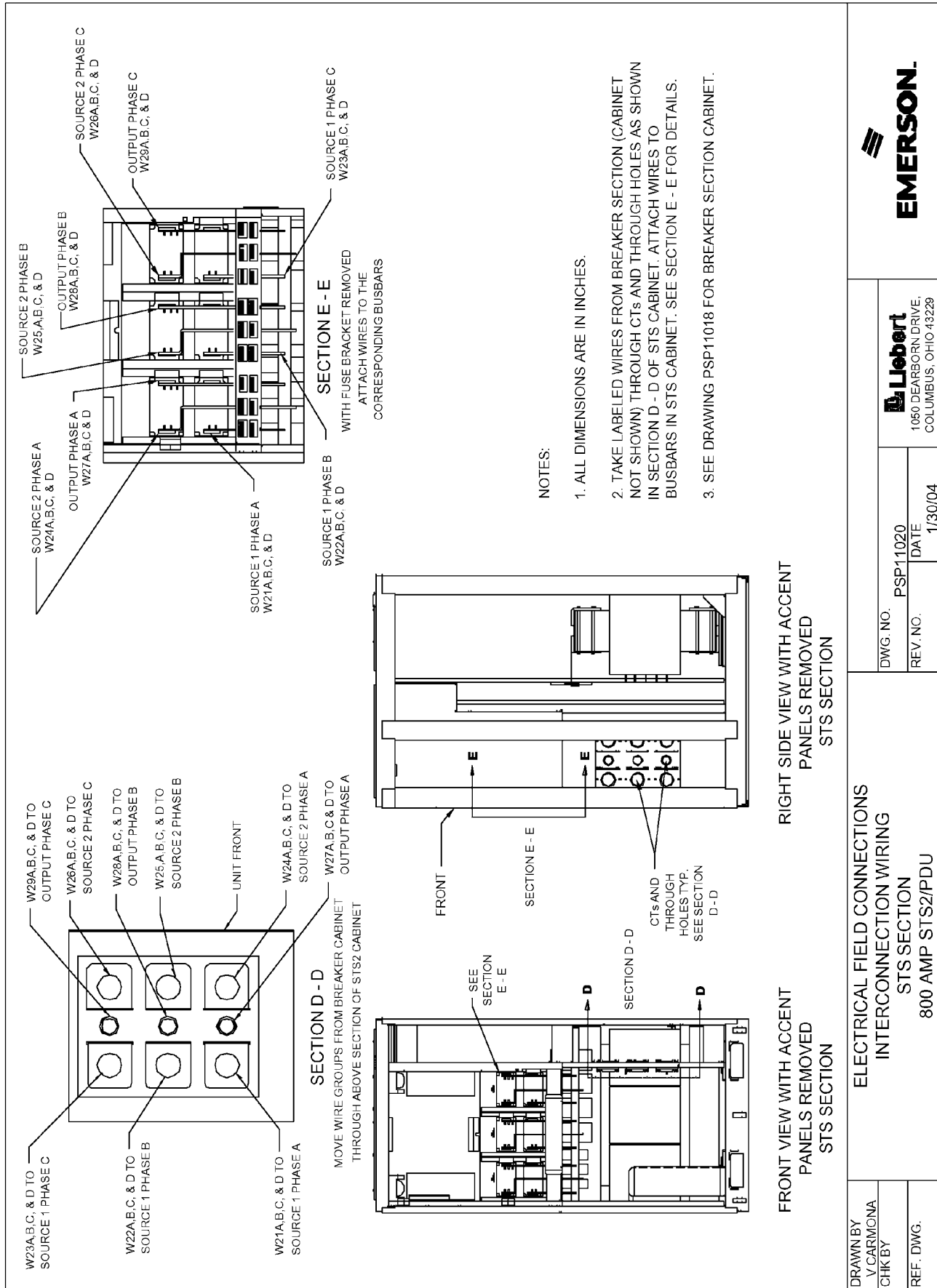

Figure 39 Electrical field connections, 800A STS2/PDU interconnect wiring, STS section



Leobert
1050 DEARBORN DRIVE,
COLUMBUS, OHIO 43229

DWG. NO. PSP11020
REV. NO. DATE 1/30/04
FILE NAME: STS2-PDU-FC-PSP11020

DRAWN BY V.CARMONA
CHK BY
REF. DWG.

Figure 40 Electrical field connections, 800A STS2/PDU interconnect wiring, left side distribution cabinet

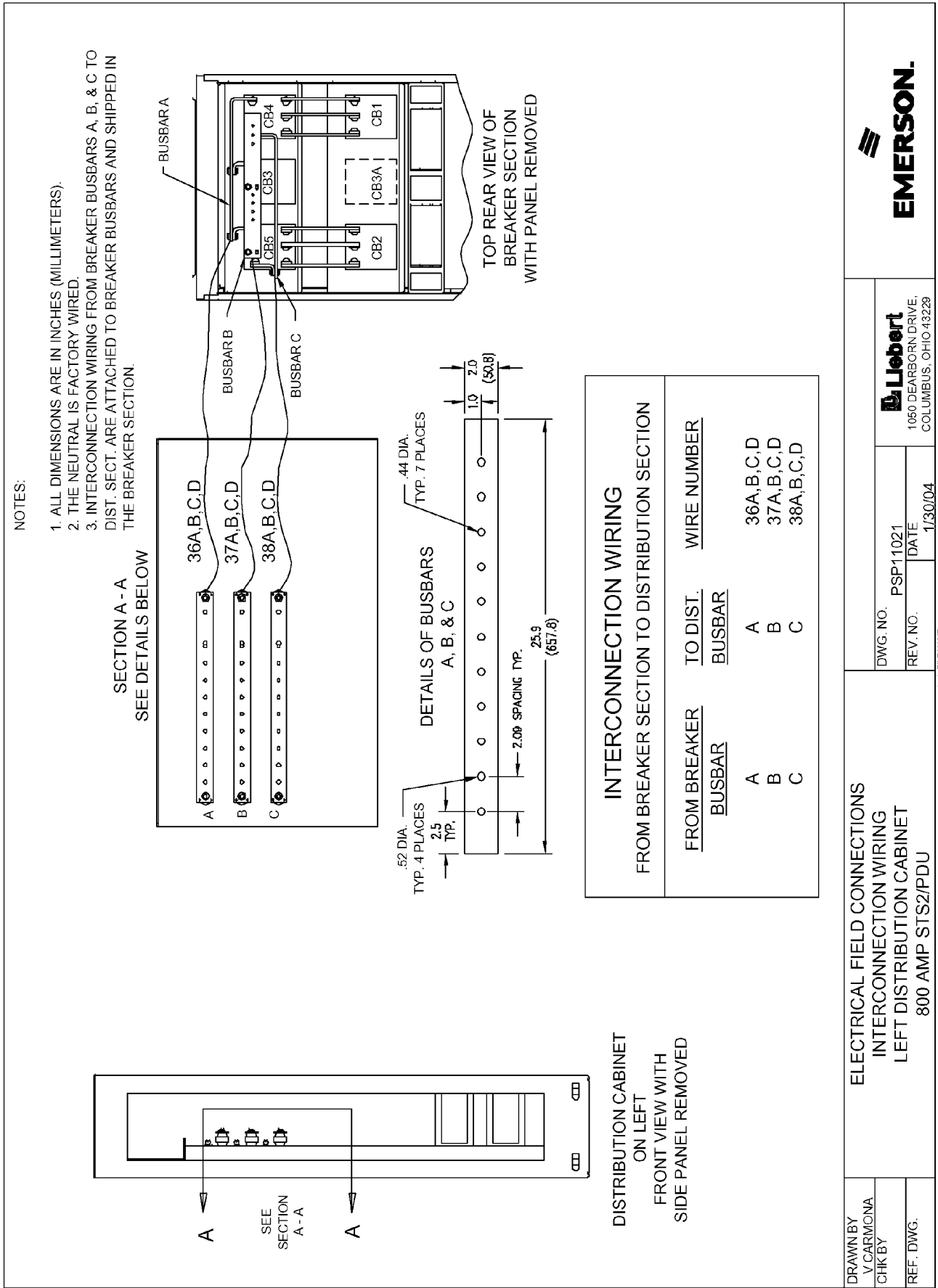

Liobert
1050 DEARBORN DRIVE,
COLUMBUS, OHIO 43229

DWG. NO. PSP11021
REV. NO. DATE 1/30/04
FILE NAME: STS2-PDU/FCSPSP11021

DRAWN BY V.CARMONA
CHK BY
REF. DWG.

Figure 41 Electrical field connections, 800A STS2/PDU interconnect wiring, left side one-line

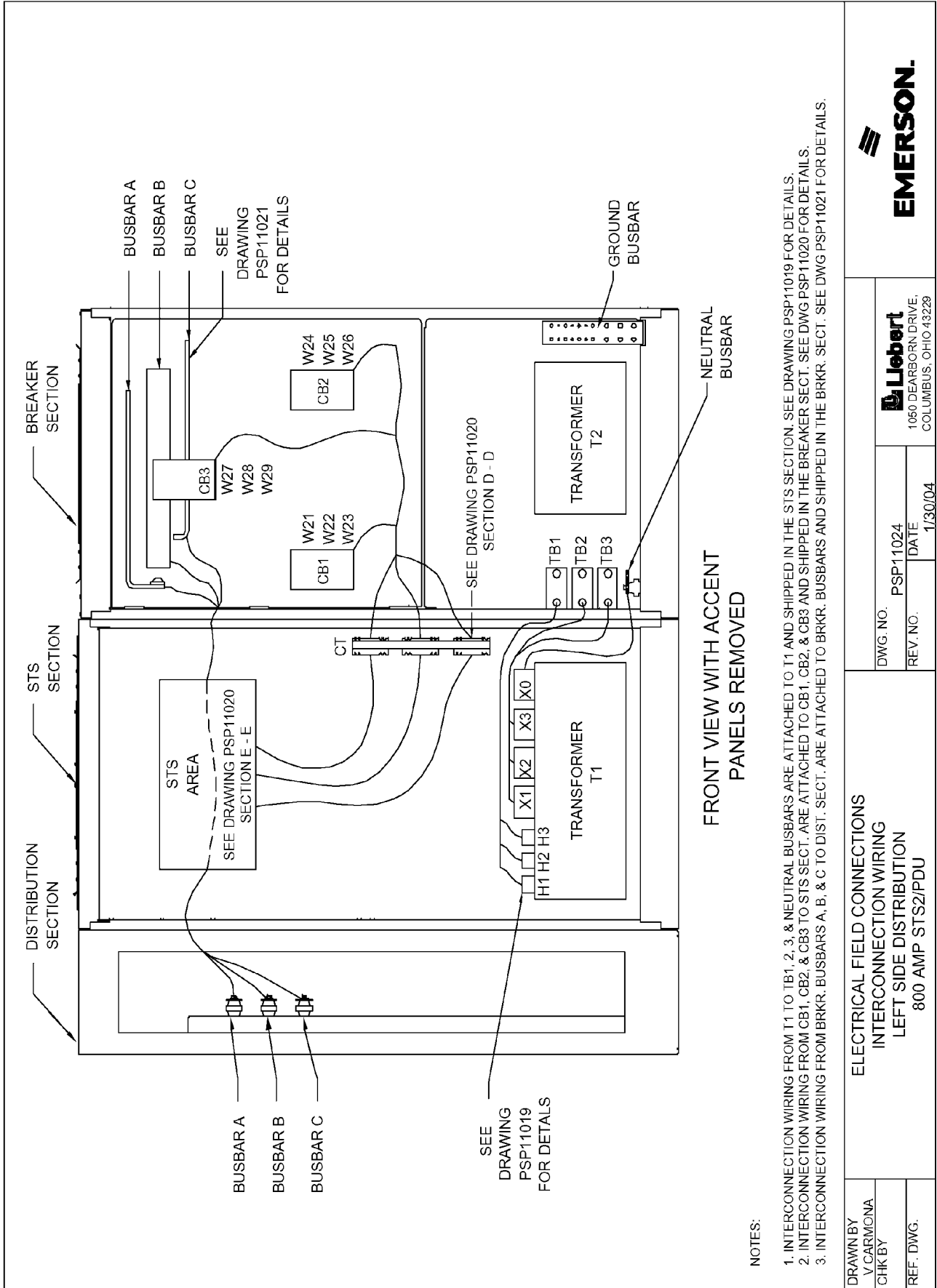

NOTES:

1. INTERCONNECTION WIRING FROM T1 TO TB1, 2, 3, & NEUTRAL BUSBARS ARE ATTACHED TO T1 AND SHIPPED IN THE STS SECTION. SEE DRAWING PSP11019 FOR DETAILS.
2. INTERCONNECTION WIRING FROM CB1, CB2, & CB3 TO STS SECT. ARE ATTACHED TO CB1, CB2, & CB3 AND SHIPPED IN THE BREAKER SECT. SEE DWG PSP11020 FOR DETAILS.
3. INTERCONNECTION WIRING FROM BRKR. BUSBARS A, B, & C TO DIST. SECT. ARE ATTACHED TO BRKR. BUSBARS AND SHIPPED IN THE BRKR. SECT. SEE DWG PSP11021 FOR DETAILS.



| | | | | | |
|--|-----------|----------------------|-----------------|---|---|
| DRAWN BY V.CARMONA | | DWG. NO. PSP11024 | |  1050 DEARBORN DRIVE, COLUMBUS, OHIO 43229 |  |
| CHK BY | REF. DWG. | REV. NO. | DATE 1/30/04 | | |
| ELECTRICAL FIELD CONNECTIONS INTERCONNECTION WIRING LEFT SIDE DISTRIBUTION 800 AMP STS2/PDU | | | | | |
| FILE NAME: STS2-PDU-FC-PSP11024 | | | | | |

Figure 42 Electrical field connections, 800A STS2/PDU interconnect wiring, left side one line with CB3A



NOTES:

1. INTERCONNECTION WIRING FROM T1 TO TB1, 2, 3, & NEUTRAL BUSBARS ARE ATTACHED TO T1 AND SHIPPED IN THE STS SECTION. SEE DRAWING PSP11019 FOR DETAILS.
2. INTERCONNECTION WIRING FROM CB1, CB2, & CB3A TO STS SECT. ARE ATTACHED TO CB1, CB2, & CB3A AND SHIPPED IN THE BREAKER SECT. SEE DWG PSP11020 FOR DETAILS.
3. INTERCONNECTION WIRING FROM BRKR. BUSBARS A, B, & C TO DIST. SECT. ARE ATTACHED TO BRKR. BUSBARS AND SHIPPED IN THE BRKR. SECT. SEE DWG PSP11021 FOR DETAILS.

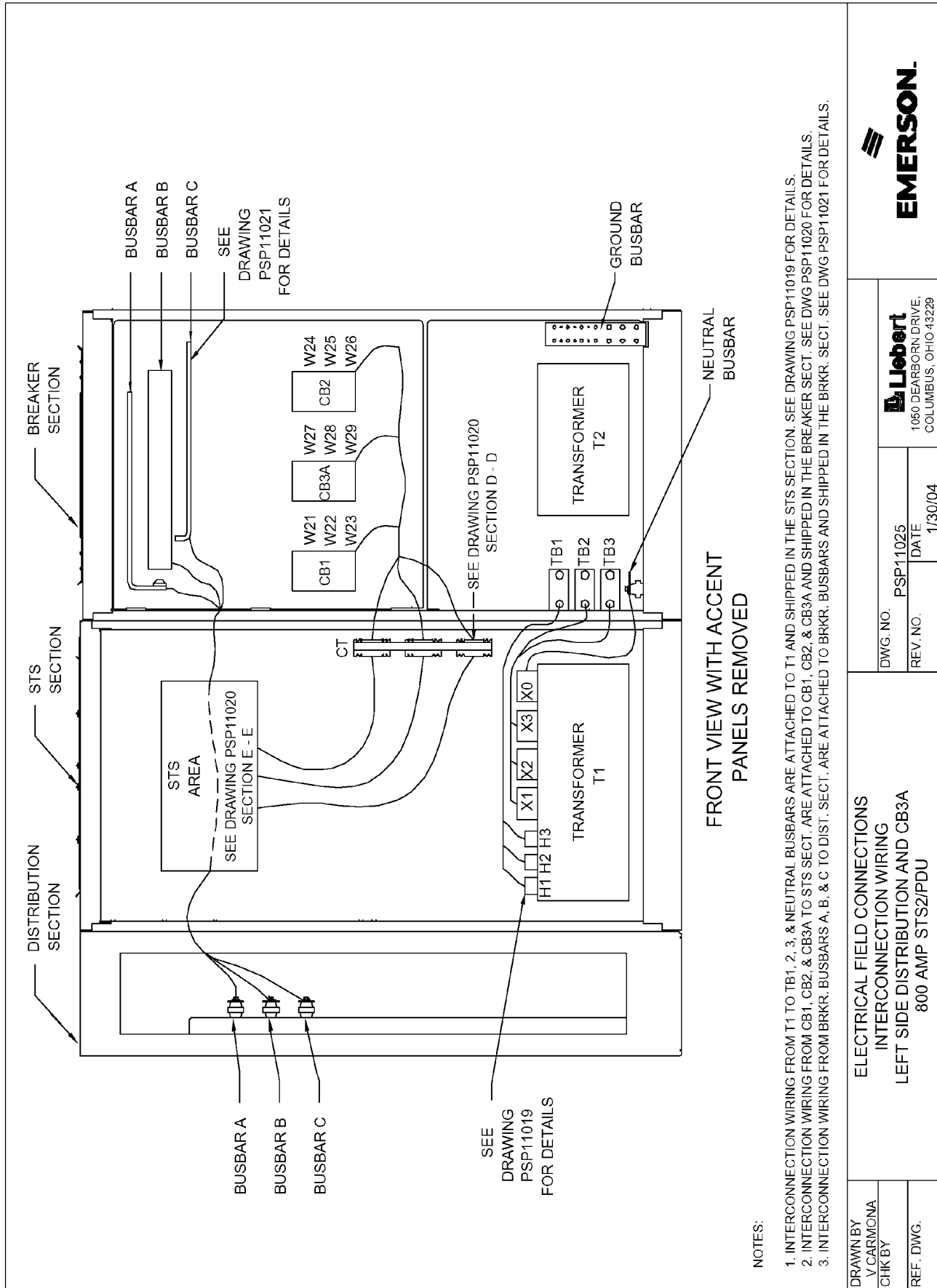
| | | | | | |
|---|--|----------------------|--|--|--|
| DRAWN BY V.CARMONA | | DWG. NO. PSP11025 | | EMERSON | |
| CHK BY | | REV. NO. | | 1050 DEARBORN DRIVE, COLUMBUS, OHIO 43229 | |
| REF. DWG. | | DATE 1/30/04 | | FILE NAME: STS2-PDU-FC-PSP11025 | |
| ELECTRICAL FIELD CONNECTIONS INTERCONNECTION WIRING LEFT SIDE DISTRIBUTION AND CB3A 800 AMP STS2/PDU | | | | | |

Figure 43 Electrical field connections, 800A STS2/PDU interconnect wiring, right side one line

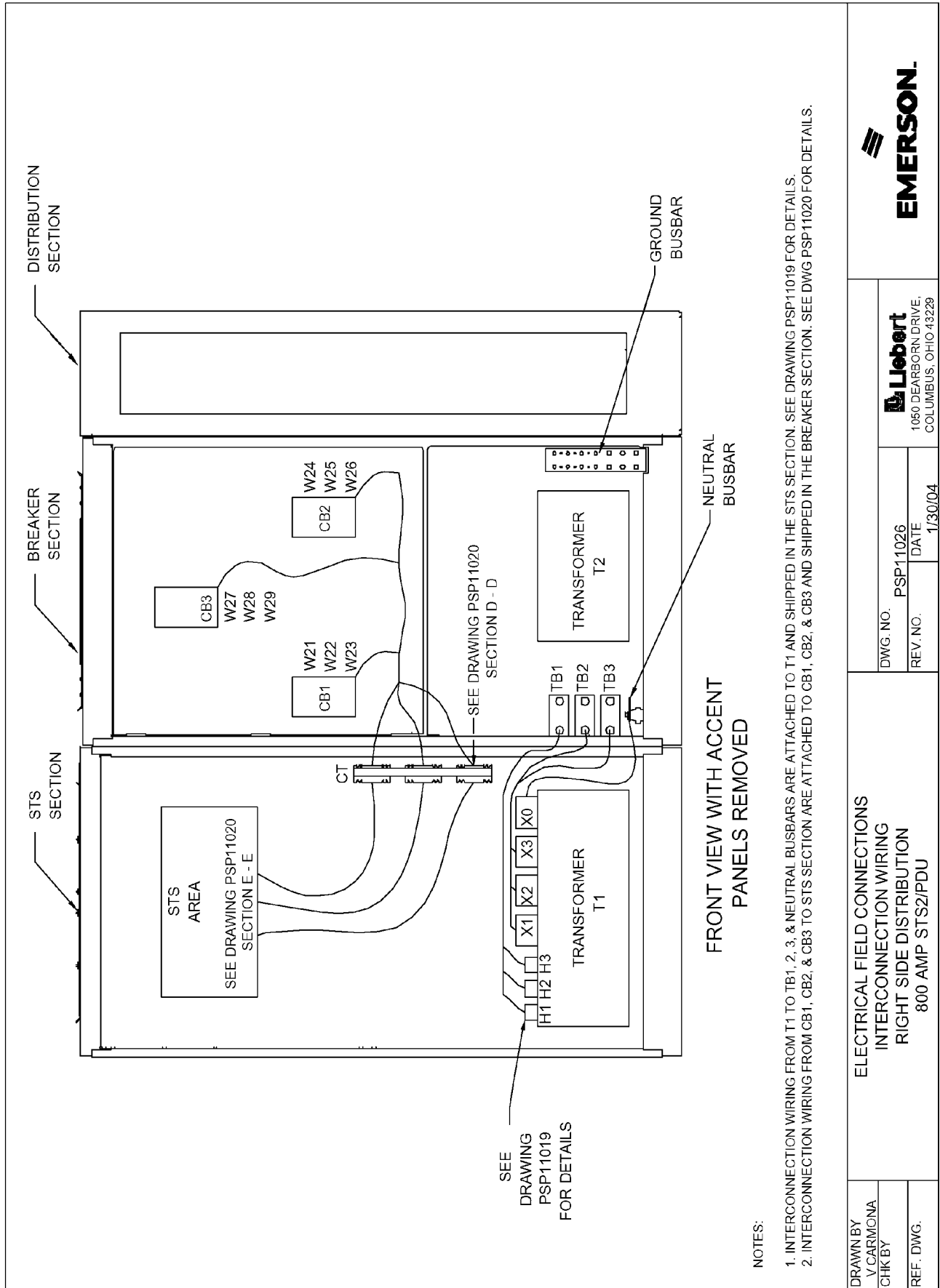

1050 DEARBORN DRIVE,
COLUMBUS, OHIO 43229

Figure 44 Electrical field connections, 800A STS2/PDU interconnect wiring, right side one line with CB3A

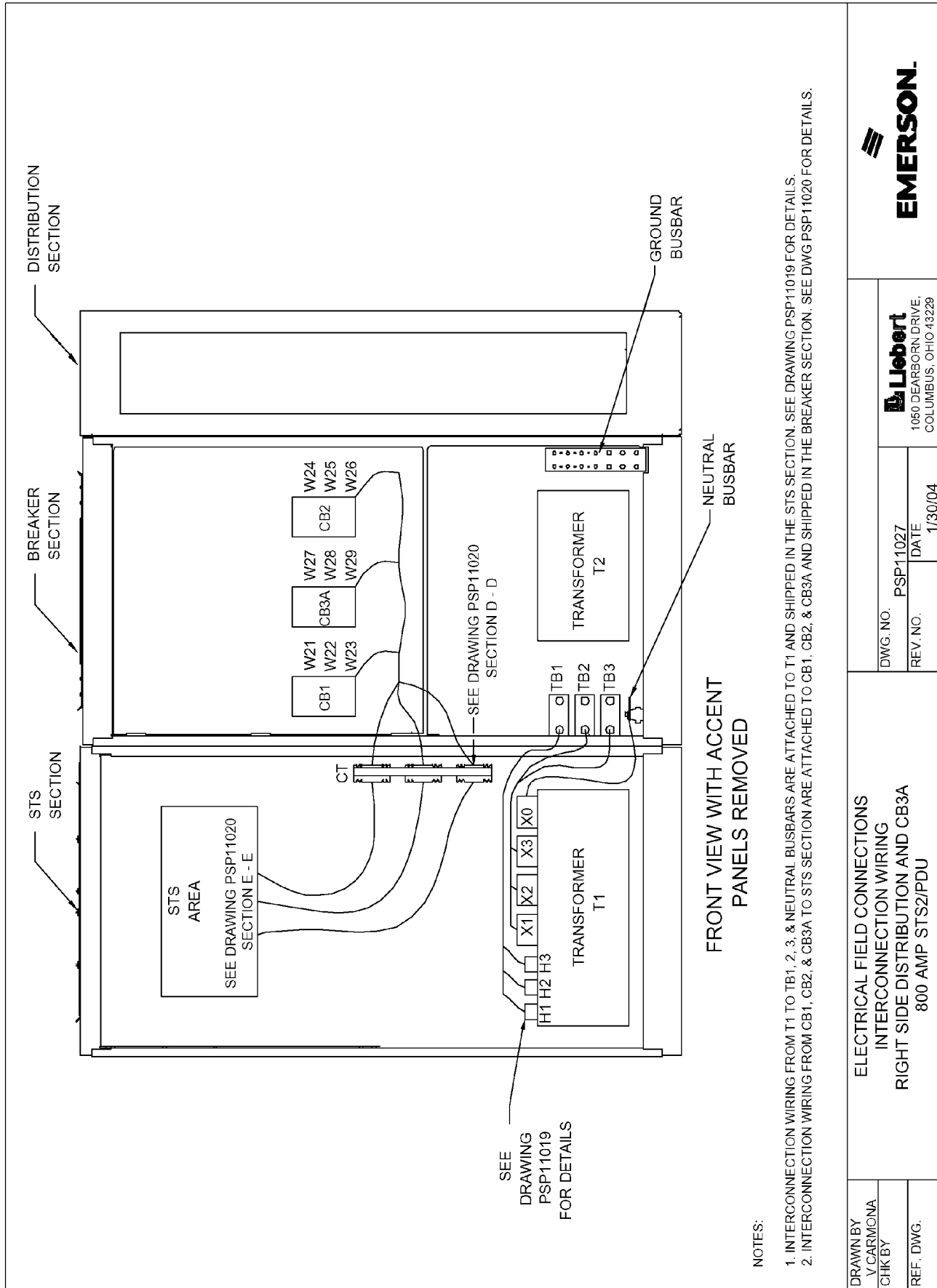
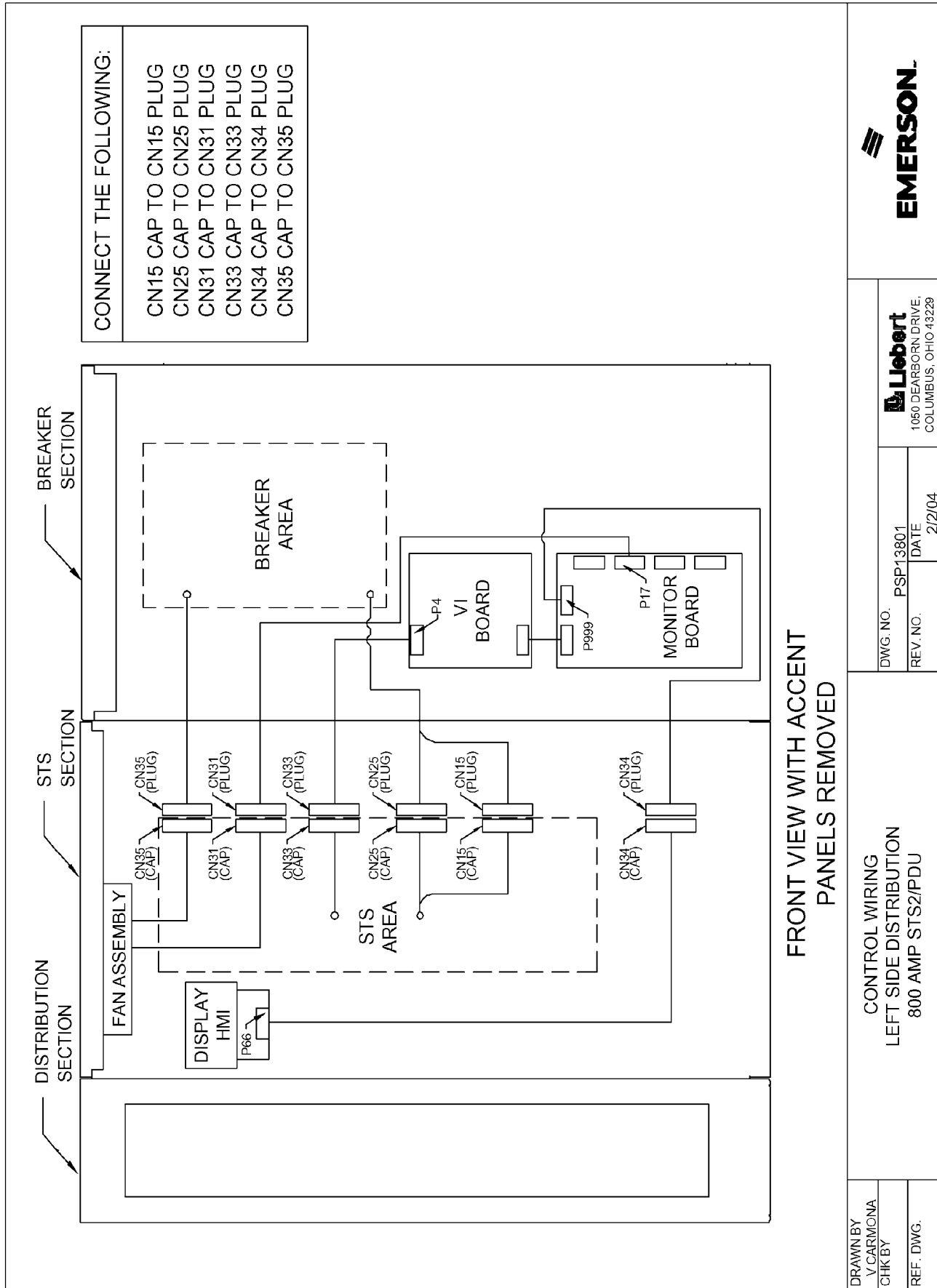

Figure 45 Control wiring, 800A STS2/PDU, left side distribution



DRAWN BY
V. CARMONA
CHK BY
REF. DWG.

CONTROL WIRING
LEFT SIDE DISTRIBUTION
800 AMP STS2/PDU

DWG. NO. PSP13801
REV. NO. DATE 2/2/04
FILE NAME: STS2-PDU-CONTROL-WIRE-PSP13801

Leibert
1050 DEARBORN DRIVE,
COLUMBUS, OHIO 43229



Figure 46 Control wiring, 800A STS2/PDU, right side distribution

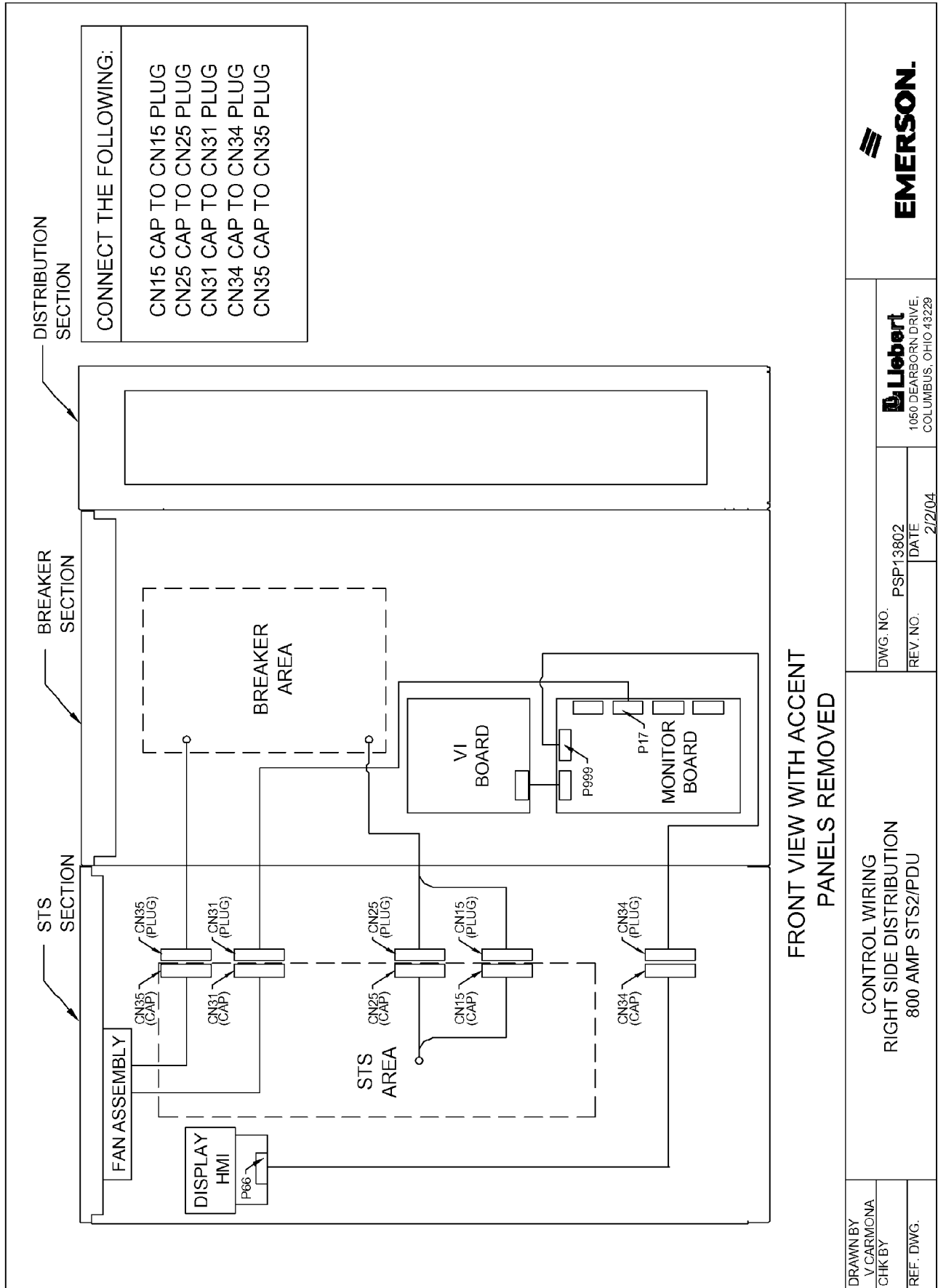

DRAWN BY
V. CARMONA
CHK BY
REF. DWG.

CONTROL WIRING
RIGHT SIDE DISTRIBUTION
800 AMP STS2/PDU

DWG. NO. PSP13802
REV. NO. DATE 2/2/04

Leibert
1050 DEARBORN DRIVE,
COLUMBUS, OHIO 43229

EMERSON.

FILE NAME - STS2-PDU-CONTROL-WIRE-PSP13802

Figure 47 Control connection location, 250A STS2/PDU

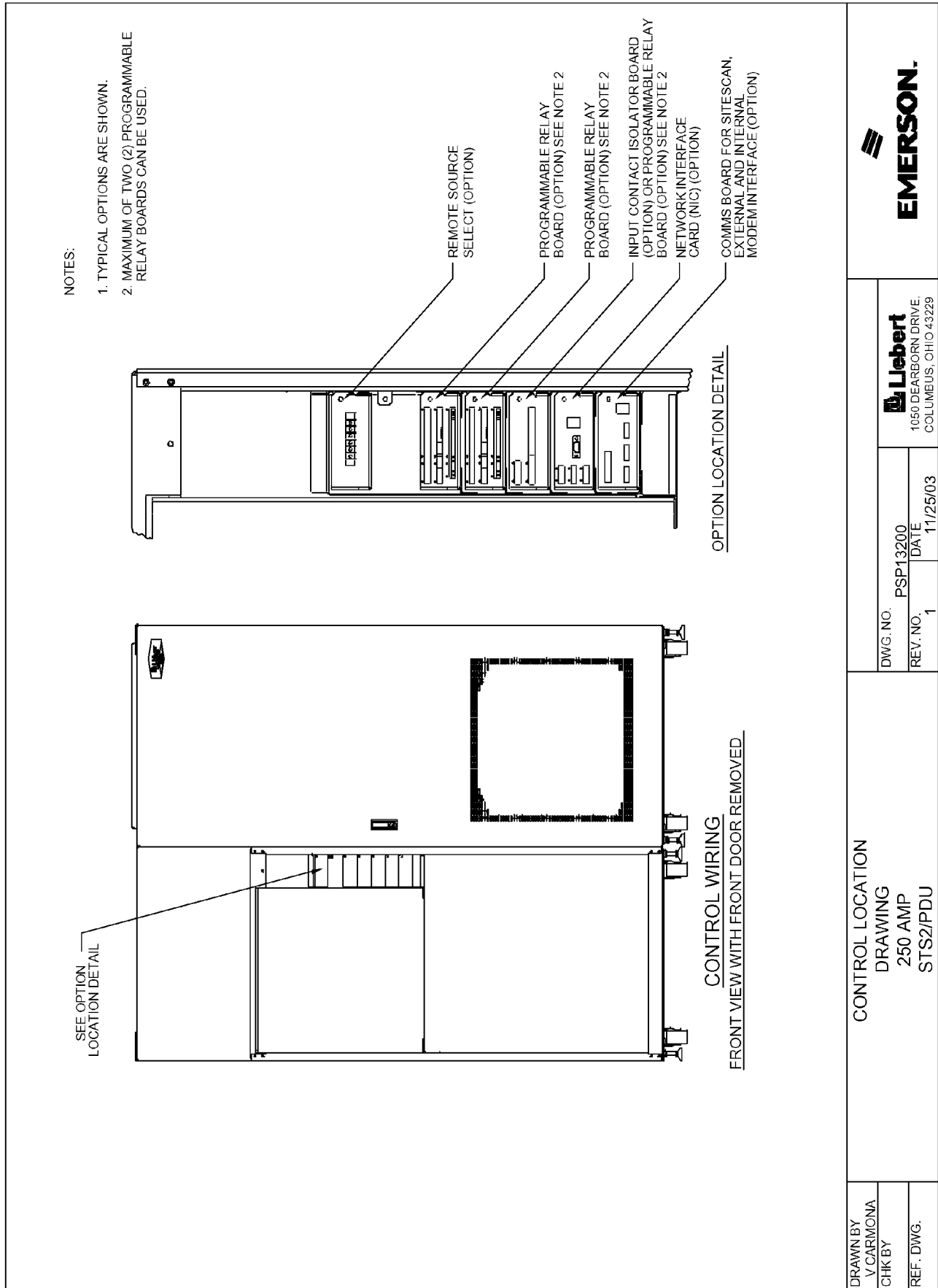
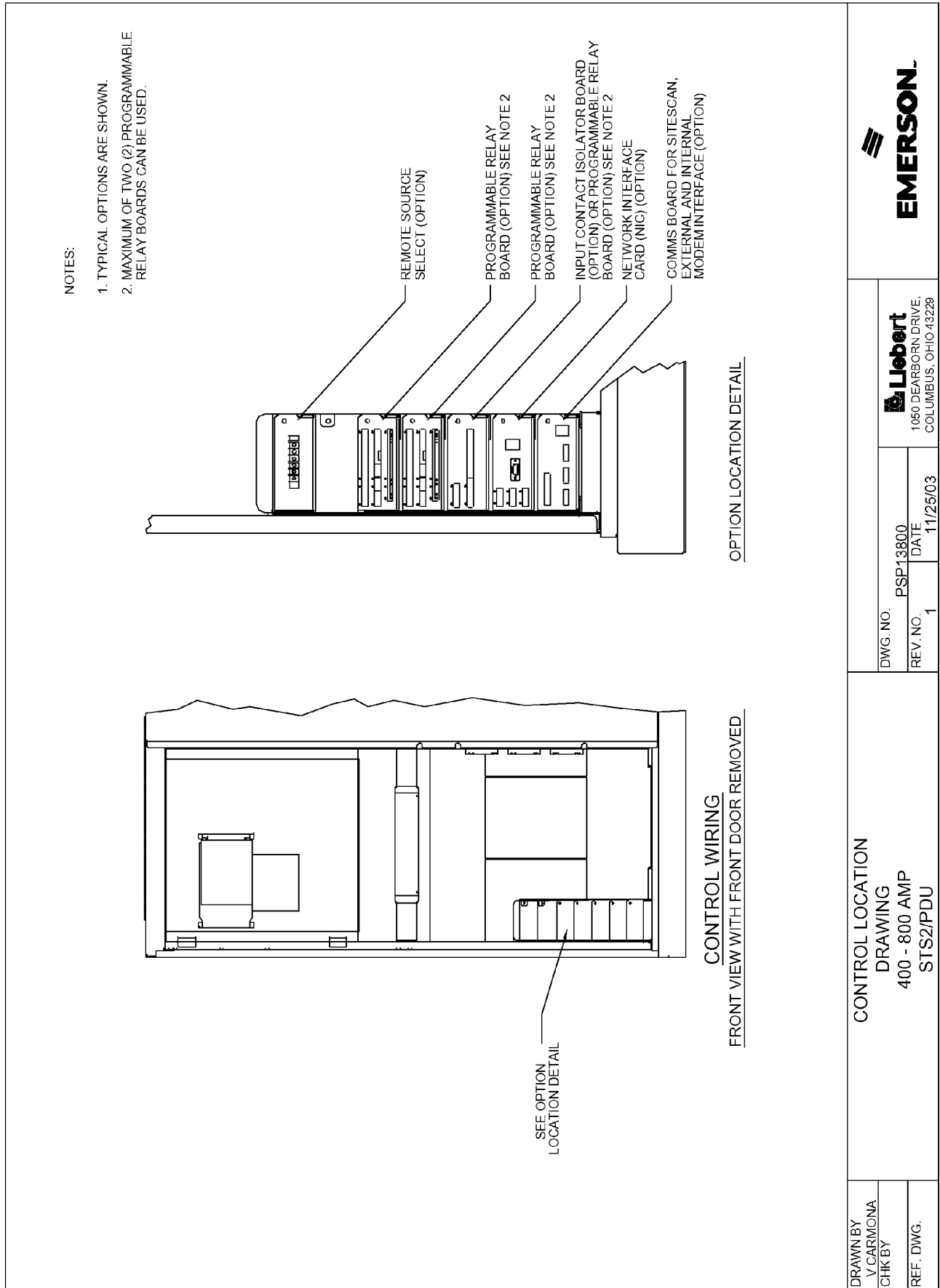

Figure 48 Control connection location, 400-800A STS2/PDU





| | | | | |
|------------------------|---|------------|--|--|
| DRAWN BY V. CARMONA | DWG. NO. PSP13800 | |  Leobert 1050 DEARBORN DRIVE, COLUMBUS, OHIO 43229 |  EMERSON |
| | CHK BY | REV. NO. 1 | | |
| REF. DWG. | CONTROL LOCATION DRAWING 400 - 800 AMP STS2/PDU | | FILE NAME: STS2PDU/CONTROLWIRE/PSP13800-01-01 | |

Figure 49 Control location drawing conduit box, top entry, 400-600A STS2/PDU

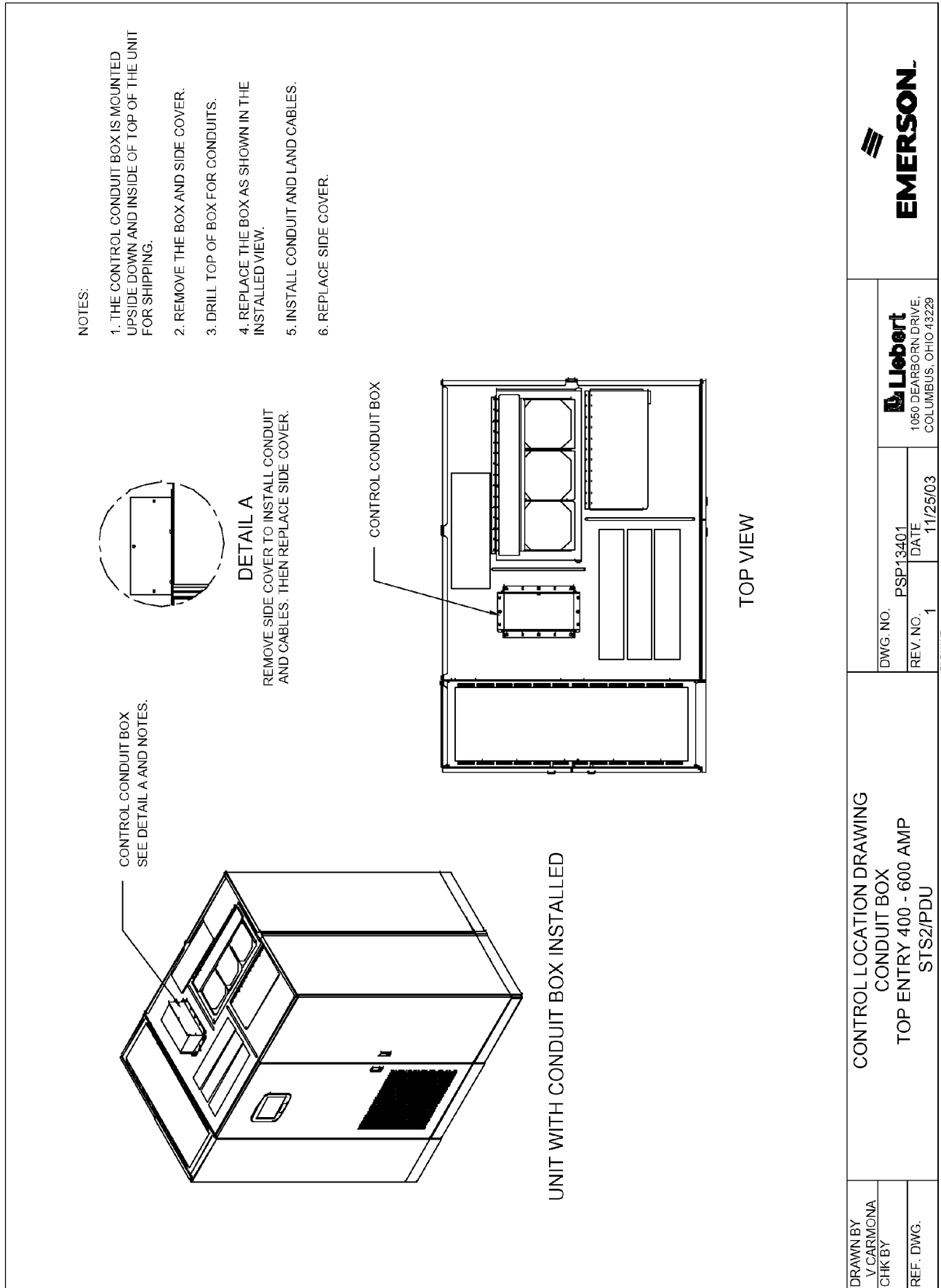

Figure 50 Control wiring for the programmable relay board option

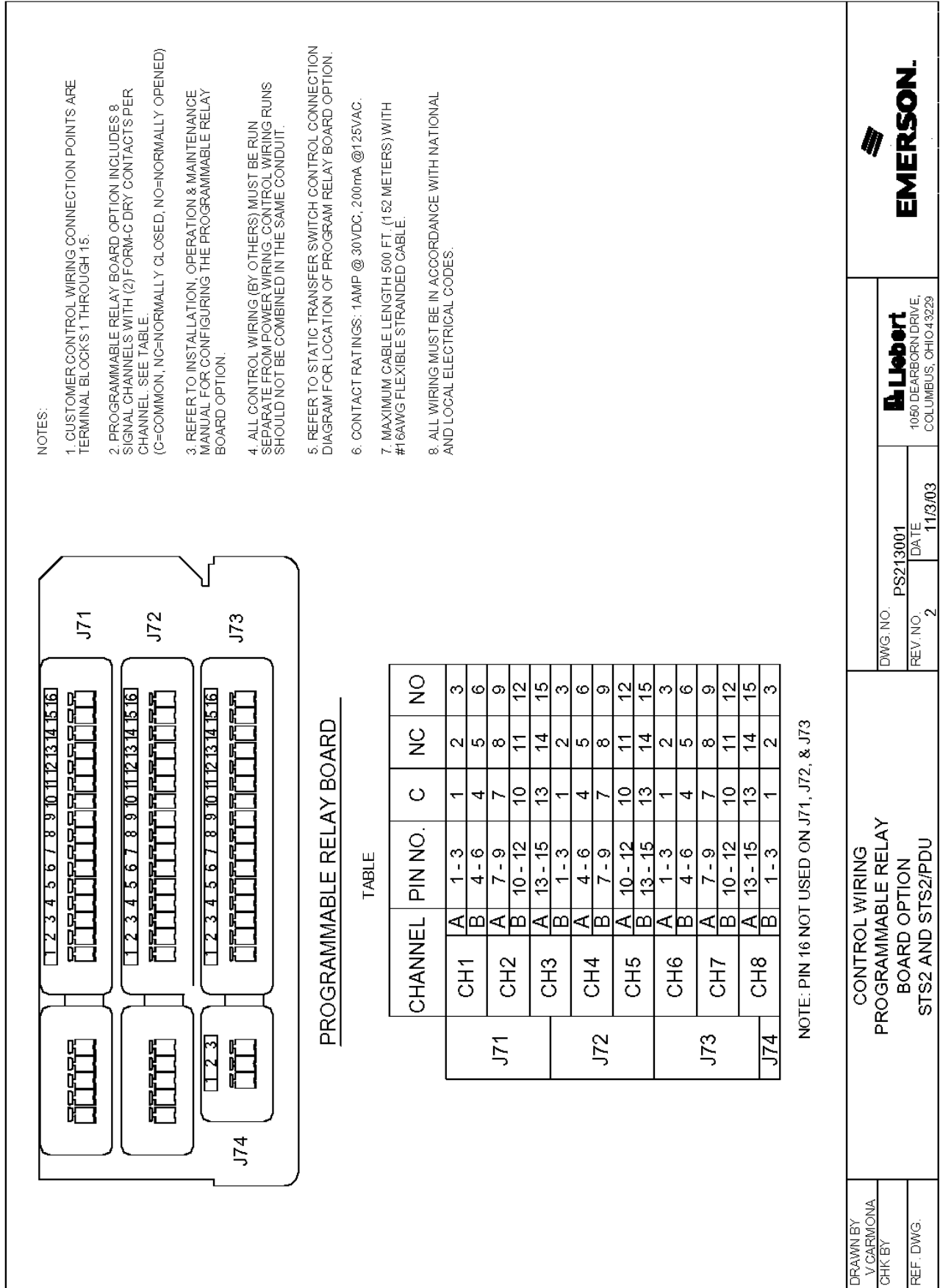

Figure 51 Control wiring for the input contact isolator board option

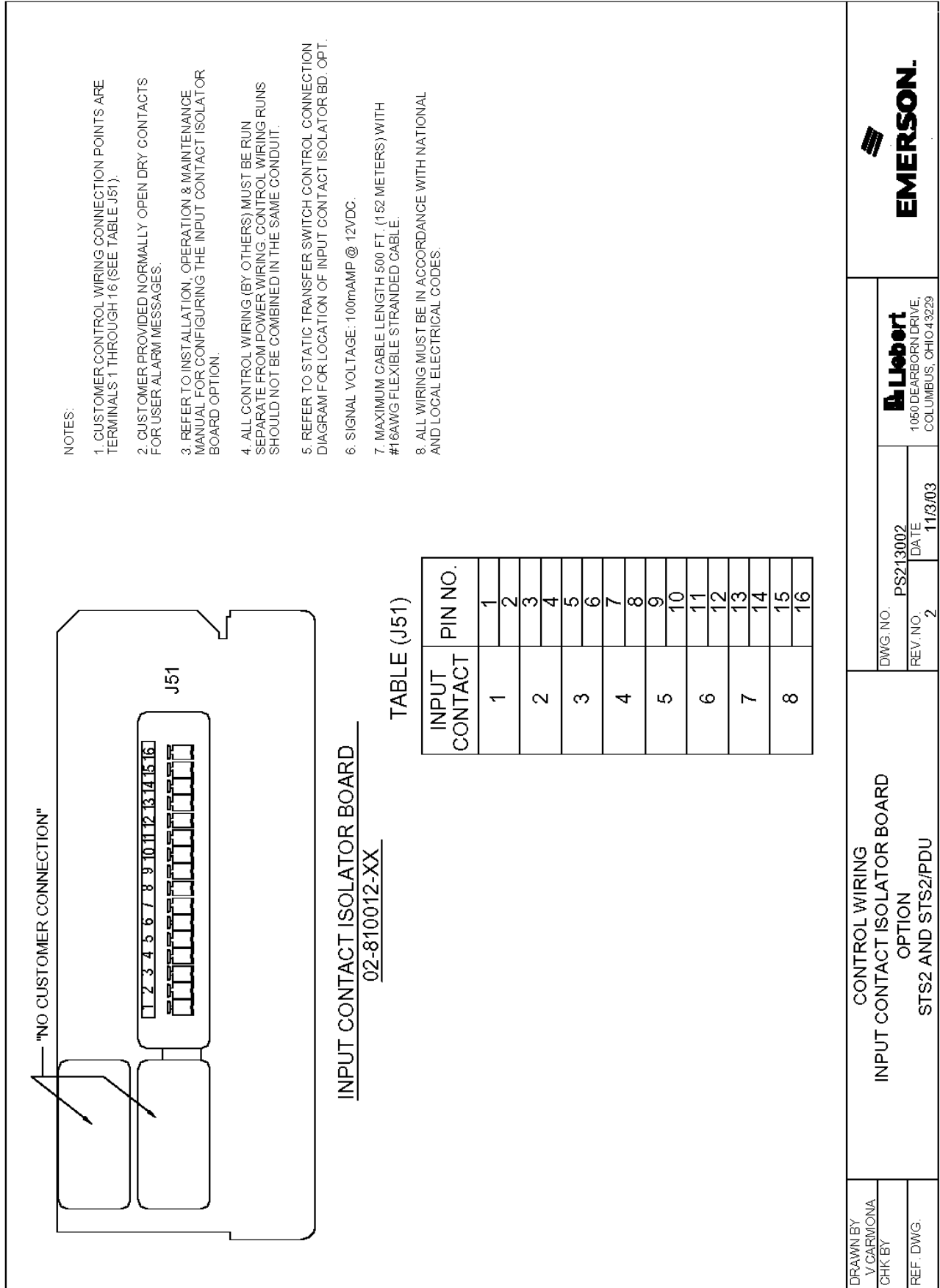

Figure 52 Control wiring for comms board

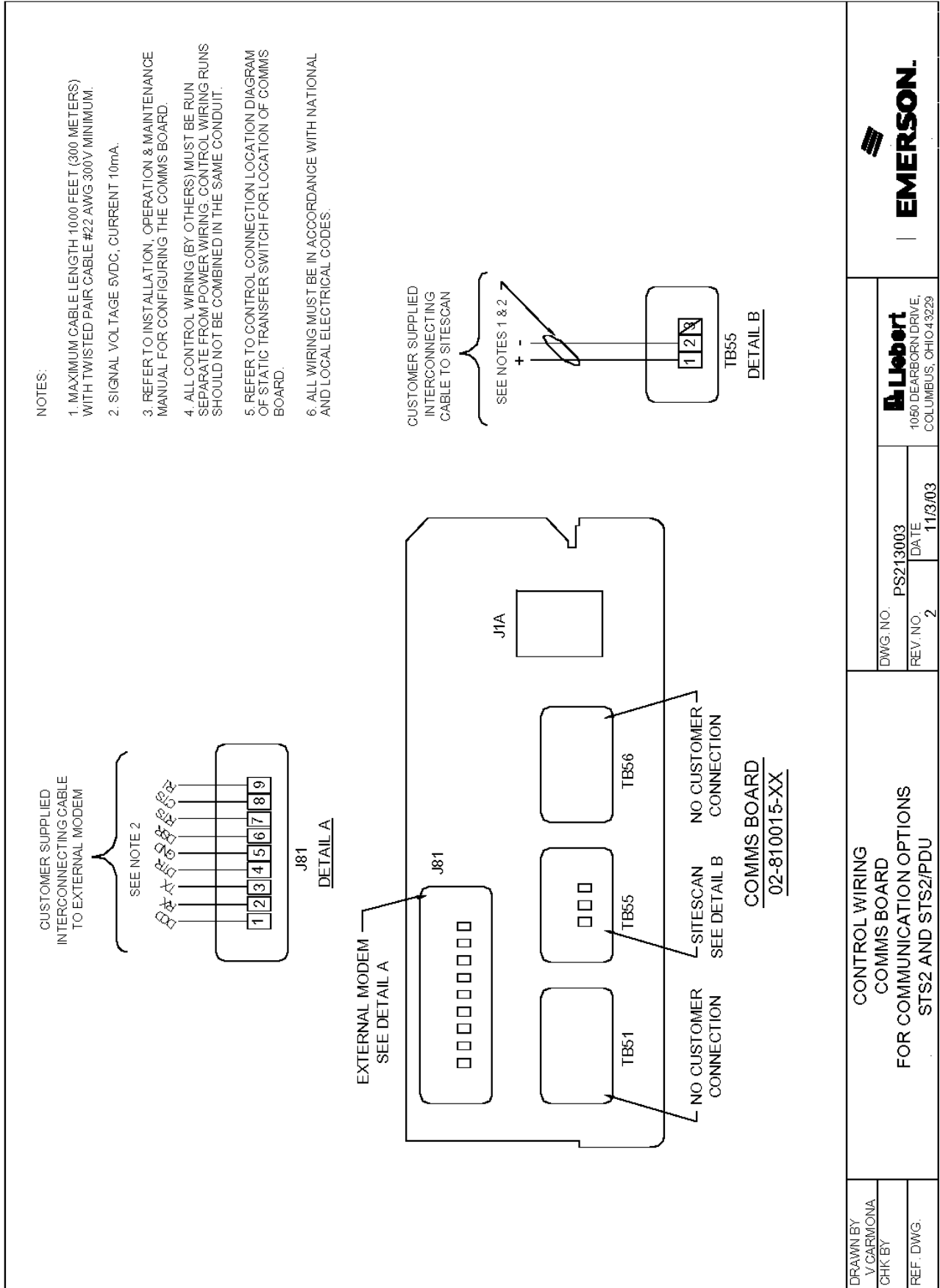

Figure 53 Control wiring for the internal modem option

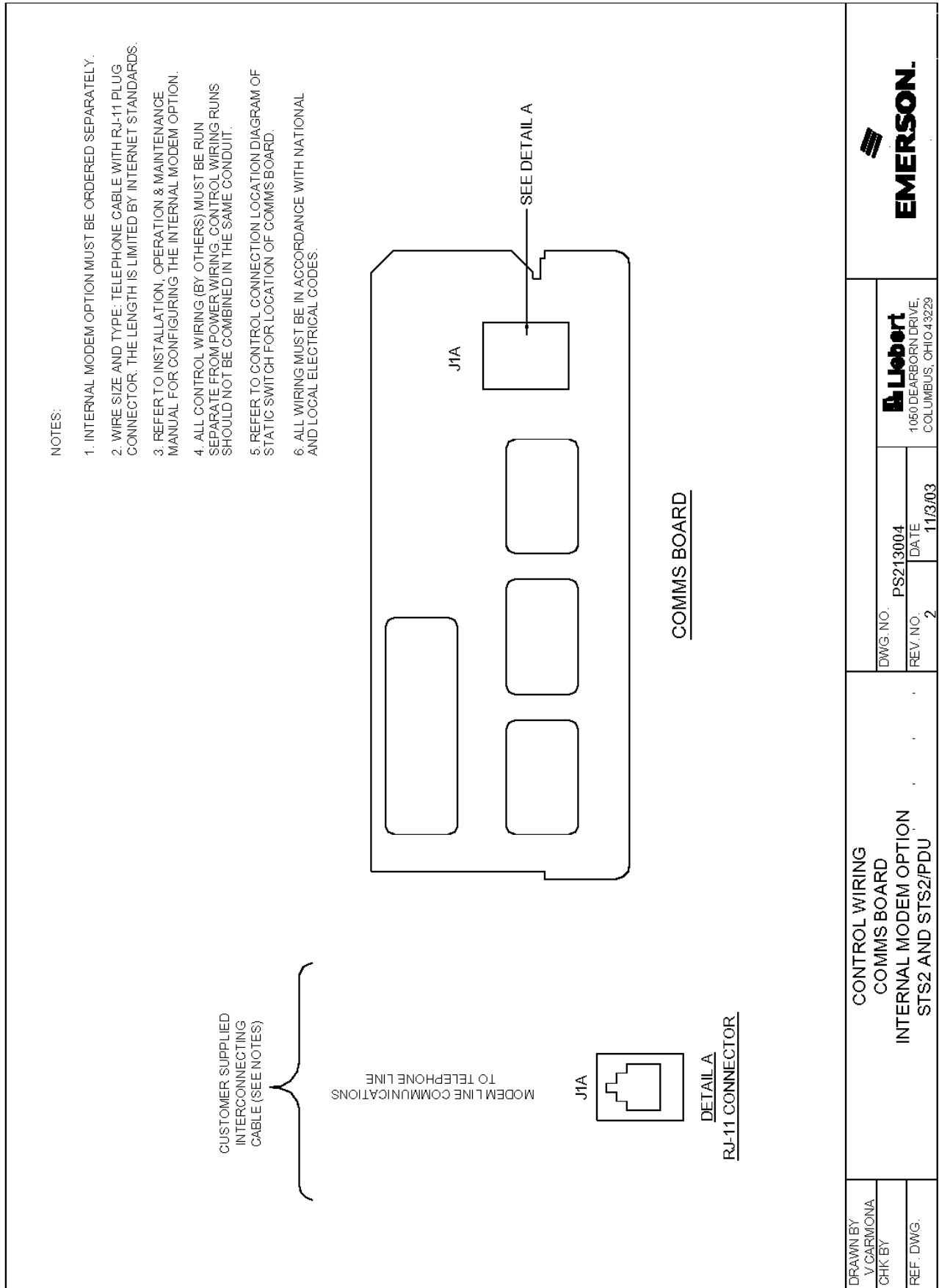

Figure 54 Control wiring for the Network Interface Card (NIC) option

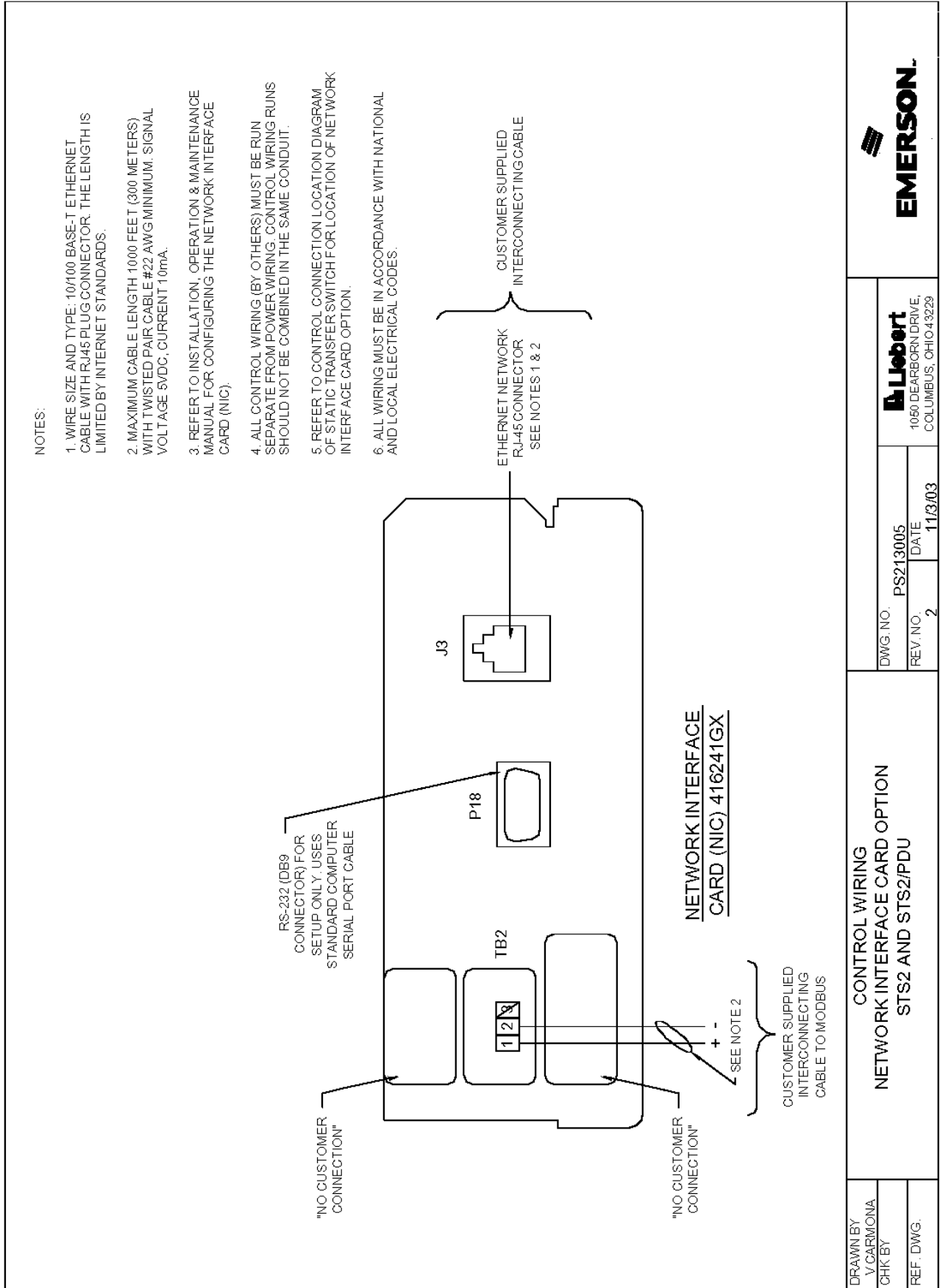

Figure 55 Control wiring for the RS-232 Port

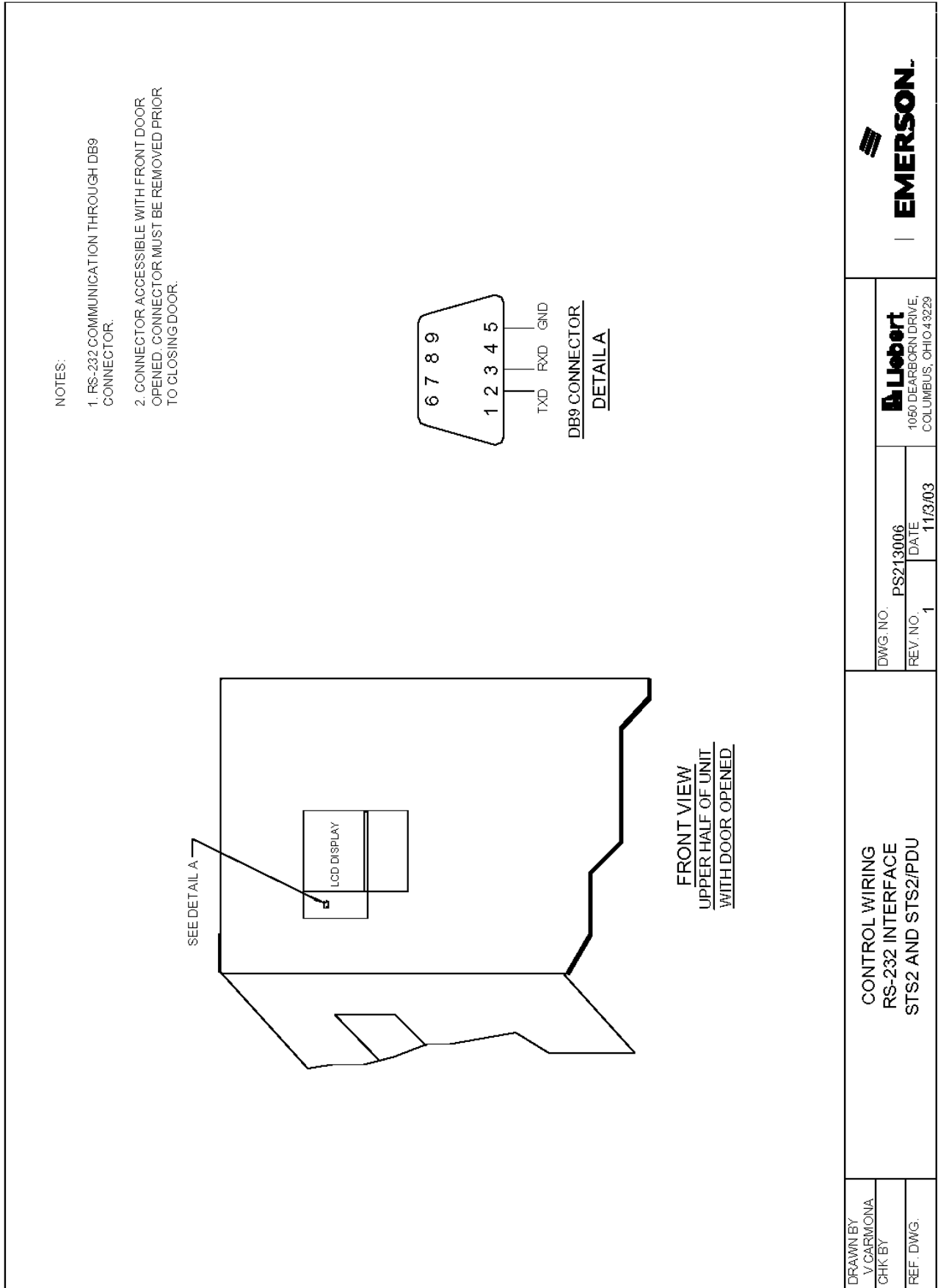

Figure 56 Control wiring for remote source selection option

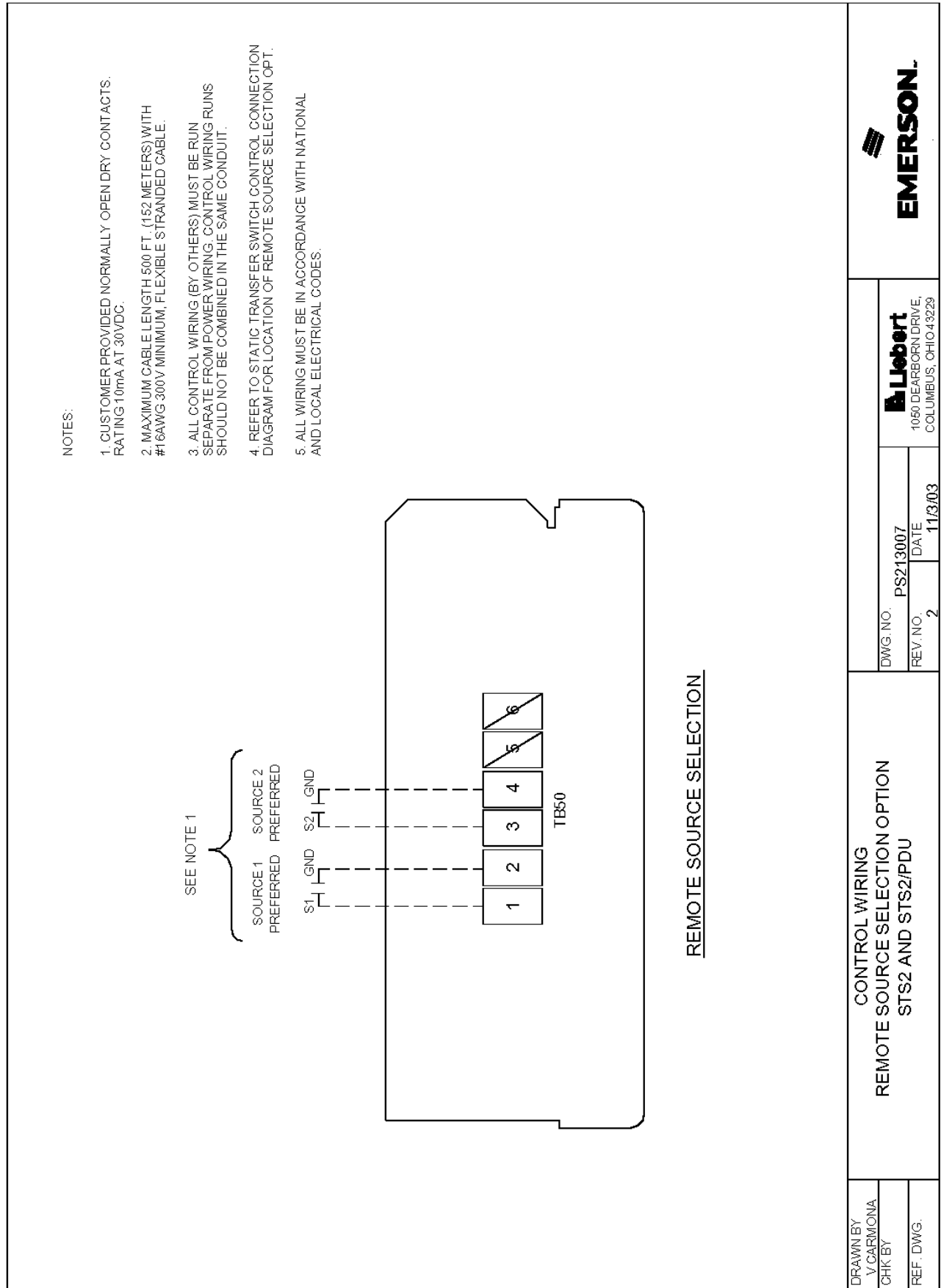

Figure 57 Color LCD touch screen display

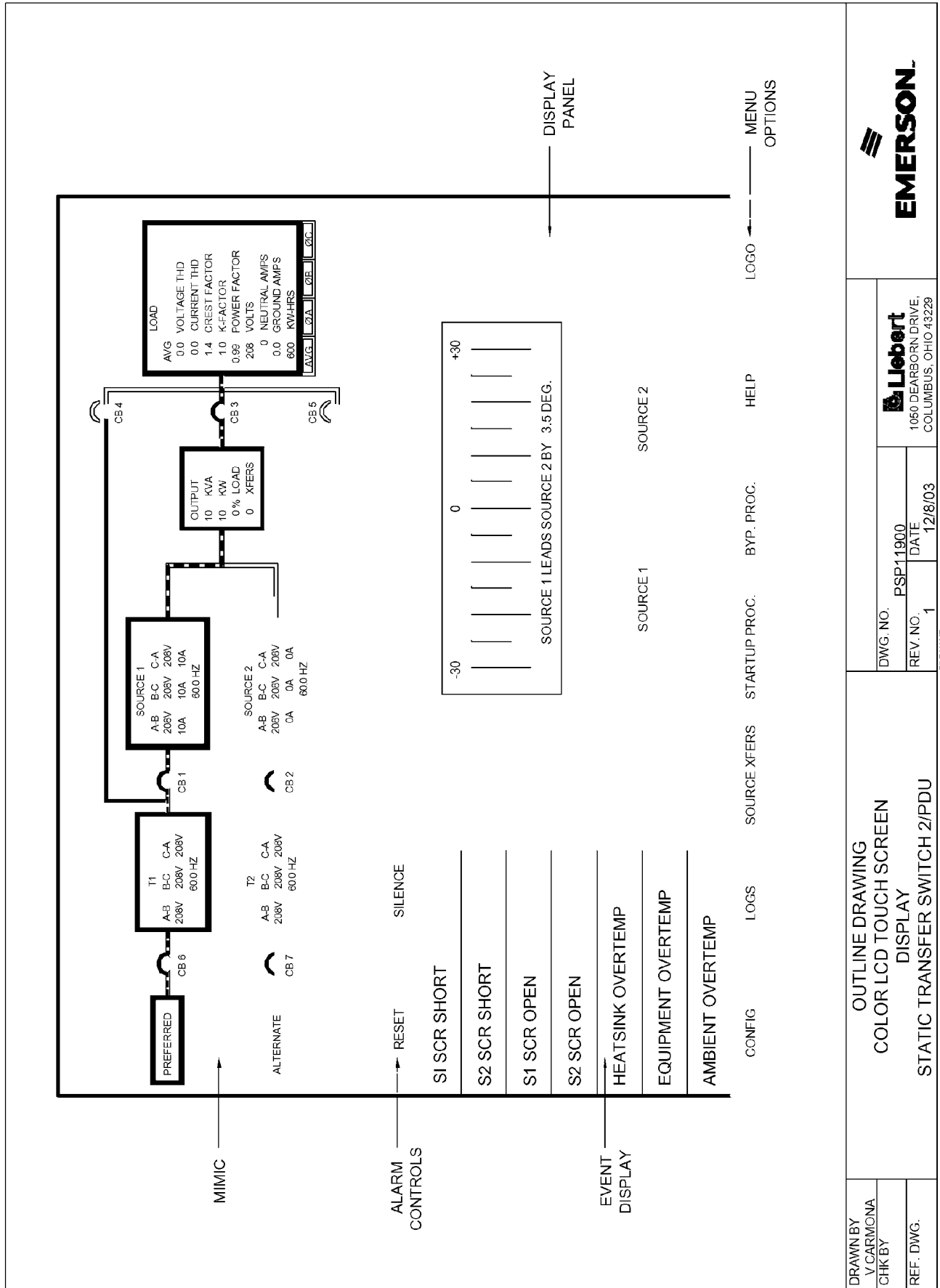

Table 9 Input circuit breaker schedule, 250-800A

| STS2/PDU Rating | STS2/PDU Input Volts | Circuit Breakers (See One-Line Diagrams) | Vendor | Type | Ampacity | Voltage | Interrupting Rating (Amps) |
|-----------------|----------------------|--|--------------|------|----------|----------|----------------------------|
| 250A | 208V | CB6 & CB7 | MERLIN GERIN | NJHN | 400A | 208-240V | 100K |
| | 480V | | | NFNN | 150A | 380-480V | 35K |
| | 600V | | | NFNN | 125A | 600V | 18K |
| 400A | 480V | CB6 & CB7 | MERLIN GERIN | NJHN | 250A | 380-480V | 65K |
| | 600V | | | NJHN | 200A | 600V | 25K |
| 600A | 480V | CB6 & CB7 | MERLIN GERIN | NJHN | 400A | 380-480V | 65K |
| | 600V | | | NJHN | 300A | 600V | 25K |
| 800A | 480V | CB6 & CB7 | MERLIN GERIN | NJHN | 500A | 380-480V | 65K |
| | 600V | | | NJHN | 400A | 600V | 25K |

Table 10 Output circuit breaker schedule, 250-800A

| STS2/PDU Rating | STS2/PDU Input Volts | Circuit Breakers (See One-Line Diagrams) | Vendor | Type | Ampacity | Voltage | Interrupting Rating (Amps) |
|-----------------|----------------------|--|--------------|------|----------|----------|----------------------------|
| 250A | 208V | CB8 | MERLIN GERIN | NJHN | 250A | 208-240V | 100K |
| 400A | 208V | CB8 | MERLIN GERIN | NJHN | 400A | 208-240V | 100K |
| 600A | 208V | CB8 | MERLIN GERIN | PJD | 600A | 208-240V | 100K |
| 800A | 208V | CB8 | MERLIN GERIN | PJD | 800A | 208-240V | 100K |

Table 11 Non-automatic breaker schedule, 250-800A

| STS2/PDU Rating | Circuit Breakers (See One-Line Diagrams) | Vendor | Type | Ampacity | Voltage | Withstand Current |
|-----------------|--|--------------|------|----------|----------|-------------------|
| 250A | CB1, CB2, CB3 CB3A, CB4, CB5 | MERLIN GERIN | NFHN | 250A | 208-240V | 100K |
| | | | | | 380-480V | 65K |
| 400A | CB1, CB2, CB3 CB3A, CB4, CB5 | MERLIN GERIN | NJHN | 400A | 208-240V | 100K |
| | | | | | 380-480V | 100K |
| 600A | CB1, CB2, CB3 CB3A, CB4, CB5 | MERLIN GERIN | NJHN | 600A | 208-240V | 100K |
| 800A | CB1, CB2, CB3 CB3A, CB4, CB5 | MERLIN GERIN | PJD | 1000A | 208-240V | 100K |

8.0 INTRODUCTION TO STS2/PDU OPERATIONS

8.1 System Description

A STS2/PDU provides an automatic, seamless transfer between input power sources to an output load. The STS2/PDU monitors the input sources, to ensure each source is operating within set parameters, as well as ensure that each source is within acceptable tolerances for a transfer between sources to be completed.

The STS2/PDU contains two static transfer switches in one enclosure to allow the unit to transfer its load between the two input sources without disruption to the output for longer than 1/4 of a cycle.

If a problem is detected with a primary (Preferred) input source and defined trigger points are reached, the STS2/PDU automatically switches the input to the other (Alternate) input source. The STS2/PDU continues to monitor both sources and can automatically transfer the load back to the preferred source, if so configured, when that source returns to acceptable operating parameters.

The system control logic automatically monitors the input sources and power output to ensure that they are operating within acceptable tolerances. The system logic manages the transfer between sources.

The STS2/PDU front panel contains a Color Graphical Display on an LCD touch screen display. The Color Graphical Display provides a menu-driven operator interface and a display of system information, status information, a one-line diagram (Mimic) of the STS2/PDU, active alarms and alarm history information.

The menu selections provide control of the preferred source, manual transfer initiation. Buttons provide for audible alarm silence and reset.

Through the touch screen, specific voltage, current and environmental parameters can be configured to trigger events that can sound an alarm, write to a history log and either transfer sources or inhibit a transfer.

Preferred input source selection, alarm reset and alarm silencing are done through buttons on the touch screen display.

Communication options provide external communication with the STS2/PDU through a modem, a network card, a programmable relay board, a contact isolator or an RS-422 port to Liebert's SiteScan.

8.1.1 Redundancy

Redundancy within the STS2/PDU prevents one component from being a single point of failure, should a problem occur. Redundant circuits and components are used to eliminate single points of failure.

Since the STS2/PDU has two input sources, no single component failure can cause a loss of power to the load. Redundant power supplies are provided which feed a DC dual-bus used throughout the unit to prevent any single-point power supply failure modes.

Three separate redundant control logic modules are built into the system. Each contains the logic necessary to run the STS2/PDU and control all transfers.

Redundant fans are provided if a primary fan fails. The redundant fans turn on to prevent overheating inside of the unit.

Should the front panel interface fail, the control logic continues to operate and the unit would transfer should a problem be detected on the preferred source. Information on the monitoring parameters would be available through the remote communication options, if available, or the DB9 (RS-232) connector located next to the LCD behind the front door. See **Figure 55** for details.

8.1.2 Reliability and Agency Requirements

The STS2/PDU is designed for high reliability and high availability with a critical bus Mean Time Between Failure (MTBF) exceeding 1,000,000 hours.

The STS2/PDU and all its options are designed, tested and certified, where applicable, to meet agency requirements as follows:

- UL 891: Standard for Switchboard, for UL and ULc listing
- UL 1008: Standard for Automatic Transfer Switches
- UL 67: Standard for Panelboard
- UL 1561: Standard for Dry Transformers
- UL 1459: Telephone equipment (Modem)
- NEC
- FCC Part 15 EMI emission limits for Class A computing devices.

The STS2/PDU uses conservatively rated components, minimizing the need to go to maintenance bypass. All normal maintenance and repair work can be done through the front panel of the unit. This access makes repairs and maintenance easier.

Gating and control logic are partitioned so that failure of one source's gating or sensing logic does not prevent the switch from transferring to the other source.

All control and logic components are mounted separate from the power components. The STS2/PDU is designed to minimize the exposure of hazardous voltages to allow safe servicing of the unit while the load is energized.

All electrical components requiring normal maintenance are replaceable without de-energizing the load, as long as one source is available. Solid-state switching devices are packaged to allow safe repair of those devices without having to de-energize the load. All non-automatic switches or circuit breakers are the plug-in or draw-out type to allow replacement without de-energizing the load. All other components, including transformers, power cables and connections, circuit breaker bases, etc., are replaceable from the front, rear or top of the unit—however, this requires all power to be removed from the unit for safety. All solid-state power switching devices are rated to prevent hazardous device failure in power systems with available fault currents up to the defined limits, as listed in **14.1.6 - Electrical Requirements**.

8.1.3 Factory Backup and Service Assistance

Because improper installation can cause a system to fail, a Liebert Global Services or a factory trained service technician should thoroughly inspect the unit to ensure it is properly installed and its operating parameters are properly configured.

Once the STS2/PDU is properly installed, you, as the on-site operator, can easily monitor the unit's operation utilizing the touch screen.

In the United States, if you need assistance or have questions, call 1-800-LIEBERT (1-800-543-2378).

Outside the 48 contiguous United States, contact Liebert Global Services, if available in your area.

For international areas not covered by Liebert Global Services, the Liebert authorized distributor can provide technical support.

8.2 Modes of Operation

8.2.1 Normal (Preferred Source)

Under normal operating conditions, the STS2/PDU routes power from the preferred input source to the output load. The unit monitors the voltage current and phase of each source to ensure that both are operating within set tolerances and that the alternate source is available, should a transfer be required.

8.2.2 Transfer

Should the preferred source fail or be outside acceptable voltage limits, the STS2/PDU transfers the input to the alternate source until the problem is rectified in the preferred source. The unit can be set to automatically transfer the input back to the preferred source or allow the transfer to be done only manually.

8.2.3 Transfer Inhibit

For a transfer to be completed between input sources, the sources must meet certain parameters or the transfer cannot take place. Uninterrupted transfer between sources is inhibited due to input source failure, sources out of sync, switch failure or the unit is in bypass mode.

8.2.4 Bypass

The Static Transfer Switch 2 Power Distribution Unit can be manually bypassed to allow the power from a source to directly flow to the output load. This bypass allows the unit's electronics to be serviced without dangerous voltages being present.

The STS2/PDU includes key-interlocked maintenance bypass breakers that allow either input source's electronics to be bypassed for maintenance without interruption of power to the load. The maintenance bypass allows all electronics to be isolated from the input, output and bypass connections. Bypass instructions are available from the touch screen and are discussed later in this manual.

8.3 Operator Controls

The STS2/PDU is equipped with an interface to configure and monitor the unit either locally or remotely. The Color Graphical Display is a touch screen LCD that provides a color diagram (Mimic) that displays the current status of the unit. System parameters are displayed and help is available to define events. See **Figure 58** below and **Figure 57** in **7.0 - Installation Drawings**. The touch screen menus allow the operator to initiate source transfers, view event and history logs and view bypass and other operational instructions.

Figure 58 STS2/PDU touch screen display

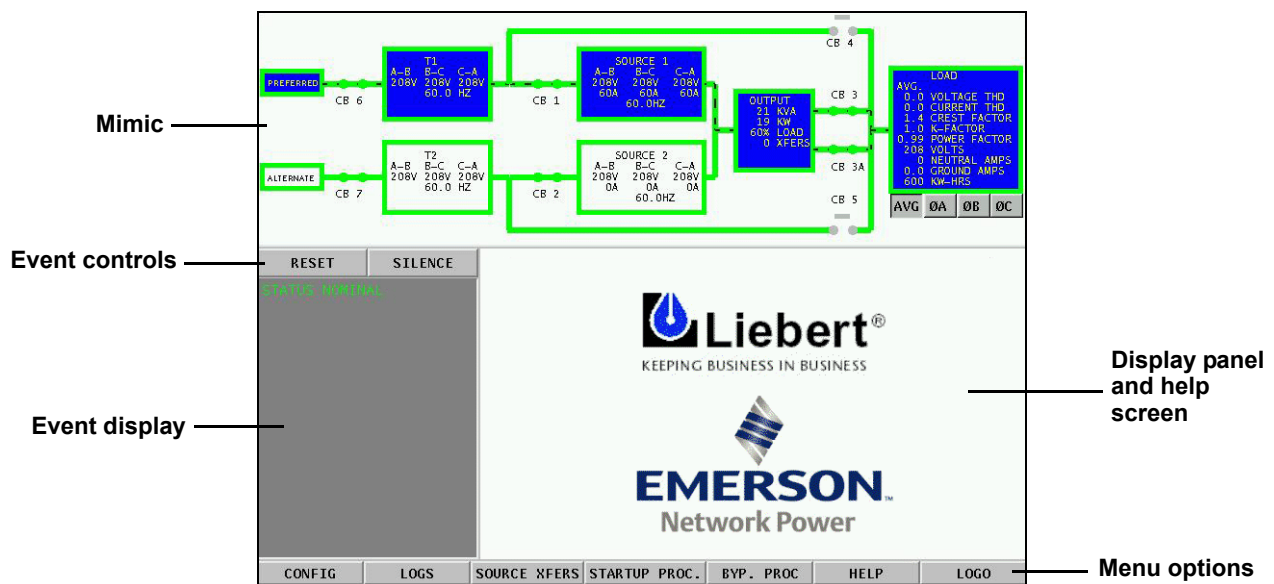

Touch screen control buttons allow you to reset alarms, silence the audible alarm, review configurations, event and history logs, preferred source, startup and bypass procedures and the help menu.

Qualified personnel, with a password, can use these menus to configure parameters, select a preferred source and do manual source transfers.

Units can be accessed from a terminal or a PC running terminal emulation software attached to the unit. Through the RS-232 access, you can monitor and configure the unit, plus remotely select a preferred source. See **12.1 - Using the RS-232 Port** for instructions on using the RS-232 interface.

9.0 THEORY OF OPERATION

9.1 General Description

The STS2/PDU contains all the equipment necessary to prevent an interruption in power flow to the AC load, should your primary source fail.

9.1.1 Static Transfer Switch 2 Power Distribution Unit

The STS2/PDU is a combination automatic static transfer switch and power distribution unit. The STS2/PDU shall include two isolation transformers connected to a solid-state, three-pole, dual-position static transfer switch designed to automatically and manually switch between two synchronized three-phase AC power sources without an interruption of power to the load longer than 4 milliseconds (1/4 cycle). Input, output, bypass circuit breakers and a distribution section shall be included to form an integrated system in a single freestanding enclosure.

The preferred source is the input source that normally carries the load when both sources are available. The preferred source is selectable by the user from the LCD panel or an optional Remote Source Selection. The unselected source is referred to as the alternate source and carries the load if the preferred source should fail or if a manual transfer is initiated.

The unit uses Silicon Controlled Rectifiers (SCRs) connected in paralleled, opposing pairs to function as an AC switch configuration. Three pairs of SCRs connect the AC load to the selected preferred input source as long as the preferred source is available. A second set of SCRs stands ready to transfer the AC load to the alternate input source should the preferred source fail. The switching action is a very fast, break-before-make with less than a 1/4 cycle break in the AC waveform.

During static switch transfers and retransfers, the conduction state of the SCRs is carefully monitored and controlled to prevent a current path from one source to the other. This technique prevents a faulted source from feeding into the other good source.

9.1.2 Source Transfer

The STS2/PDU allows manually initiated transfers between the two sources, providing the alternate source is within acceptable voltage limits and phase tolerances with the preferred source. You begin a manual transfer by selecting the inactive source as the preferred source. On a manual transfer, the STS2/PDU transfers between the two sources with less than one (1) millisecond interruption of power to the load. The transfer can only be completed when both sources are available and synchronized within the user-adjustable phase synchronization window. For sources where the two frequencies are not exactly in phase, manually-initiated transfers are delayed by the STS2/PDU until the two sources are within the defined phase synchronization window.

Source selection can also be done remotely using the Remote Source Selection option, if installed.

9.1.3 Automatic Transfer/Retransfer

If the preferred source is out of voltage and/or frequency limits, the load is automatically transferred to the alternate source. The default transfer voltage limits comply with the limits of the IEEE Std. 446-1995 computer voltage tolerance envelope.

If the unit is so configured, the load is retransferred automatically to the preferred source after the preferred source returns to within the acceptable voltage and frequency limits for at least the defined retransfer time delay and is in phase with the alternate source. You can enable and disable automatic retransfer to the preferred source through a user configuration setting.

Automatic Retransfer Inhibited

If the system makes five transfers from the preferred source to the alternate source in a five minute period, automatic retransfers back to the preferred source is disabled.

To clear this alarm condition, you must assign the alternate source as the preferred source. Also, the UV detection thresholds may need adjustment. See **Source Setpoints on page 101** for instructions on setting the UV detection.

This alarm also is cleared if the unit transfers to the preferred source due to an alternate source AC volt failure (i.e., an emergency transfer.)

9.1.4 Emergency Transfer

To ensure that power remains connected to the load, the STS2/PDU automatically performs an emergency transfer from one input source to the other when an outage occurs on the existing source.

The automatic transfer takes place if the other source's voltage is within acceptable limits and regardless of the phase difference between the two sources.

Emergency transfers occur with a loss of power on the output of less than 4 ms.

Emergency transfers from the alternate source to the preferred source are not affected by the Auto Retransfer Enabled/Disabled or Retransfer Delay user settings.

9.1.5 Load Current Transfer Inhibit

The STS2/PDU senses the load current. If the load current exceeds the preset level deemed to represent a load inrush or fault condition, the unit's logic disables manual and automatic transfers, even if the selected source's input voltage is outside the acceptable limits. This event triggers an I-Peak alarm. If so configured, the Load Current Transfer Inhibit is automatically reset after the current and voltage return to within normal parameters. This reset provides continued protection against a source failure. The Load Current Transfer Inhibit also can be programmed to require a manual reset. See **Step 14 in Source Setpoints on page 101** for details.

9.1.6 SCR Failure

The STS2/PDU continuously monitors the status of the SCR switching devices for proper operation. In the event of a shorted SCR on the input source powering the load, the STS2/PDU automatically triggers an alarm and trips open the other source isolation breaker. In the event of a shorted SCR on the other input source, the STS2/PDU automatically triggers an alarm and trips open the other source isolation breaker.

In the event of an open SCR, the switch automatically triggers an alarm and transfers the load to the other source. All open and shorted SCR alarm conditions are latched and require the system to be repaired and reset to restore normal operation.

9.1.7 On/Off Sequence

The STS2/PDU contains no master On/Off push button control. When connected to the input sources, the unit's logic power comes on automatically. The touch screen display is active as long as at least one input source is energized and the Control Power Disconnect (located inside the static switch) is closed.

9.2 Detailed Component Description

9.2.1 Controls

Operator Interface

The STS2/PDU Color Graphical Display unit contains a touch screen color LCD to provide the operator interface to control and configure the operation of the unit and quickly diagnose problems. A password and an optional keylock, if installed, are provided for security.

Hardware

- The STS2/PDU operator interface in the Color Graphical Display unit is designed to provide all of the information required to configure and monitor the unit's operation.
- The control logic performs automatic operations with minimal operator interface.
- Each STS2/PDU unit is equipped with a color LCD touch screen.
- The STS2/PDU can have optional communication ports installed. See **6.0 - Options** and **12.0 - Communication Interfaces** for more information on communication options.
- The RS-232 interface is used for configuration and status and event log monitoring.

Firmware

The operator interface enables you to monitor the STS2/PDU, to configure setpoints for transfers, monitor system parameters and access event and history logs. The firmware is accessible through the LCD touch screen or the RS-232 interface. The firmware includes:

- View and set the preferred source.
- View and configure setpoints.
- View alarms, faults and status.
- The mimic graphical representation of the systems operation.
- Menu driven monitoring and configuration.
- Step-by-step instructions to assist you in the start-up, shut-down and bypass operations.
- Help on event messages.
- Touch screen alarm reset and silence buttons.

Events in the system, both faults and alarms, are detected and displayed on the LCD. See **11.0 - Alarms and Faults** for more information on events.

- A set of event masks can be configured through the LCD to trigger a system response to an event. See **11.1 - Event Mask**.
- Report event conditions from other components of the system.
- Monitor and report changes in event condition states. If the event condition's state changes from inactive to active, a new event is detected. If the transition is from active to inactive, the event condition has cleared.
- Process new faults and alarms and clear inactive alarms.
- Provide the alarm reset and silence options.

9.2.2 Circuit Breakers and Non-Automatic Circuit Breakers

Input circuit breaker for each source provides over current protection for the STS2/PDU. Three non-automatic circuit breakers provide total isolation of the solid-state switching devices with an input non-automatic breaker for each source and a load isolation non-automatic breaker. Two non-automatic breakers provide for maintenance bypassing of the solid-state switching devices to either input source.

All breakers in the STS2/PDU are plug-in types, which allows any breaker to be replaced without de-energizing the output bus. The breakers have an interlock in the plug-in base, which prevents the switch from being withdrawn in the CLOSED position. The switch trips OPEN before it disconnects from the plug-in base.

See **14.2.5 - Circuit Breakers** for specifications and more information pertaining to the circuit breakers. See **Figures 23** through **36** for circuit breaker locations.

The circuit breaker schedule is provided in **Tables 9** through **11**.

9.2.3 SCRs

Brick-type SCRs are used rated to carry the full 100% rated load. The unit is a fuseless design with input circuit breakers providing overcurrent protection.

9.2.4 Logic Modules

The logic contains three separate redundant logic modules. The modules contain the logic necessary to run the STS2/PDU and control transfers and shunt trips under all circumstances, without any outside assistance once set-up and started properly.

9.2.5 Audible Alarm

An audible alarm is installed on the control board. This alarm is triggered by an alarm condition detected on the unit. The alarm can be turned off from the touch screen. Turning off the audible alarm does not clear or reset the condition that triggered the alarm.

9.2.6 RS-232 Port

An RS-232 serial port is provided to allow an external terminal to be connected as another user interface. See **12.1 - Using the RS-232 Port** for more information.

10.0 OPERATING INSTRUCTIONS



CAUTION

Before unit is placed into service for the first time, after equipment relocation or after the equipment has been de-energized for an extended period, a thorough equipment inspection and supervised start-up by qualified personnel are strongly recommended. Contact your local Liebert representative or Liebert Global Services at 1-800-543-2378 to arrange for equipment inspection and start-up.

After the initial equipment start-up, the following operating guidelines can be used for standard equipment operation. These guidelines should be reviewed for any special equipment modifications, special site conditions or company policies that may require changes to the standard equipment operation.

All programmable functions are preset at the factory to enable the unit to be brought up without the need to enter all selectable parameters.

The LCD touch screen is discussed in more detail in **13.0 - Touch Screen Display**.

See **Figures 23 through 36** for circuit breaker locations.

10.1 Normal System Turn-On

- Depending on the type of distribution used:
 - If equipped with output breaker CB8, open CB8.
 - If equipped with output inline panelboards, open panelboard main breakers CB8 and CB9 and, if supplied, CB10 and CB11.
 - If optional subfeed breakers are supplied, open subfeed breakers CB12 and CB13.

See **Figures 3 through 6** for location of breakers.

- Retract the bolts on the key interlocks for CB1 and CB2.
 - Extend the bolts on the key interlocks for CB4 and CB5, thus preventing CB4 or CB5 from being turned ON.
- Apply source/input power to both STS2/PDU inputs by closing CB6 and CB7.

The touch screen control panel should become active and operate properly when at least one of the inputs is energized.
 - Verify that nominal input voltages are applied to both inputs (Source 1 and Source 2).

The input voltages, selected preferred source, breaker and switch status and alarms are indicated on the Mimic screen.

Figure 59 STS2/PDU touch screen display

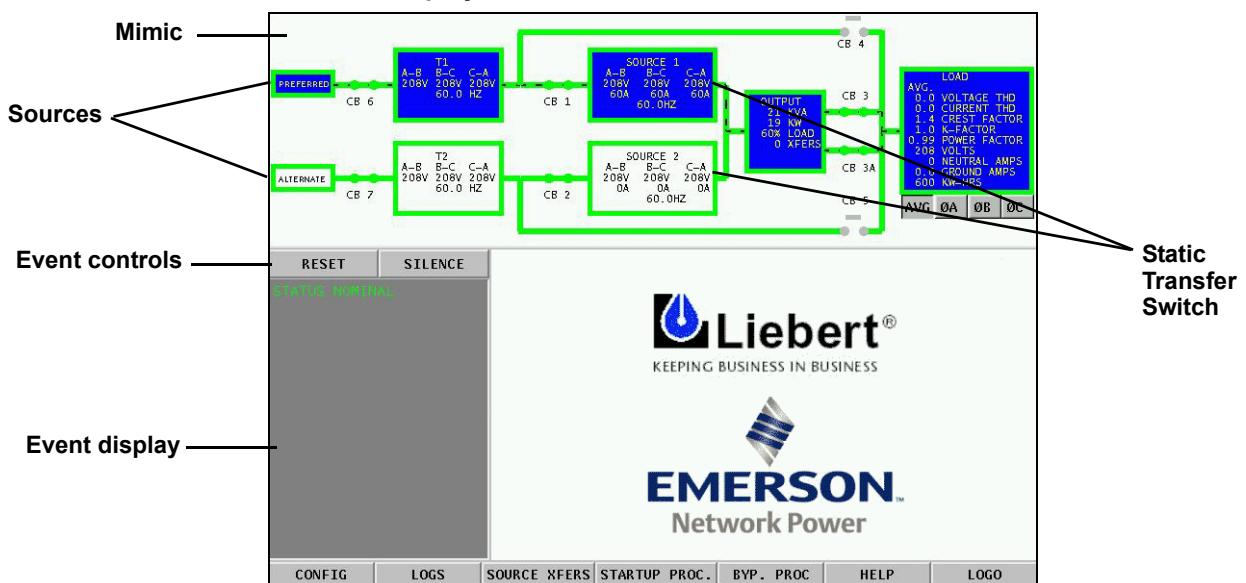

4. Close CB1.
5. Verify that Source 1 voltages are nominal and that CB1 breaker status is correctly indicated on the Monitor/Mimic screen.
6. Close CB2.
7. Verify that Source 2 voltages are nominal and that CB2 breaker status is correctly indicated on the Mimic screen.
8. Verify that boxes for the preferred source and corresponding Static Transfer Switch 2 Power Distribution Unit are highlighted on the Mimic screen, indicating which side of the Static Transfer Switch 2 Power Distribution Unit is on.
9. Close Output Breaker CB3 (for redundant output configurations, also close CB3A).
10. Verify that CB3, the Output box and the Load box are highlighted, indicating that CB3 is closed and the STS output is energized. On units with I-line panelboard, the panelboard is also energized.

**NOTE**

For redundant output configurations, CB3 descriptions apply to CB3 and CB3A.

11. Press the RESET button on the touch screen to reset any previous alarms.
12. Check the Event Display and the Mimic to verify there are no active alarms. If any active alarms are displayed, refer to **11.0 - Alarms and Faults** for a description of the alarms and possible causes. Correct all active alarm conditions before proceeding.
13. If unit is equipped with output breaker CB8, close CB8. The output and load are energized.
14. If unit is equipped with output inline panelboards, close panelboard main breakers CB8 and CB9 and, if supplied, CB10 and CB11. Turn on panelboard breakers. If optional subfeed breakers are supplied, close subfeed breakers CB12 and CB13.
15. Turn on the load equipment as directed in the load equipment manufacturer's recommendations.

10.2 Manual Transfer / Preferred Source Selection

The Source Transfer option (Source Xfers) in the touch screen menu allows you to select a preferred source. Transfers are only permitted when the voltage and current are within their proper operating range and the sources are synchronized. The Source Transfer screen indicates the synchronization between the two sources, while the voltage and frequency are displayed on the Mimic. See **Figure 60**. Transfer is inhibited if the deviation exceeds the parameter set in Source Setpoints. See **User Settings on page 101**.

**NOTE**

*If one source will be de-energized for an extended period (hours or days), set the STS2/PDU to bypass mode for the remaining source. Without using bypass, if a failure occurs in the switch components for the remaining source, the STS2/PDU does not have a second source to switch to and the load would not receive power. See **14.2.12 - Maintenance Bypass** for bypass instructions.*

Figure 60 Source Transfer screen

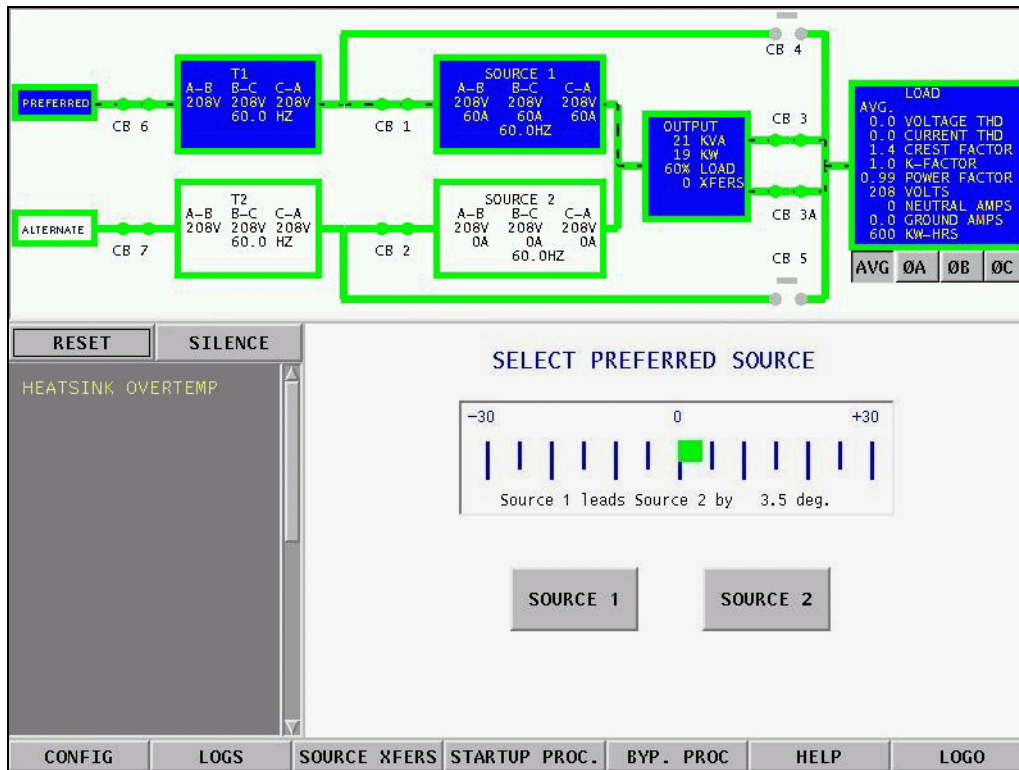

To manually select the preferred source:

1. Close the input breakers CB6, CB7, CB1 and CB2.
2. Select SOURCE XFERS from the menu bar.

The Select Preferred Source screen is displayed in the Event Display.

3. Check the Mimic to verify that Source 1 and Source 2 input voltages are correct.
4. Select SOURCE 1 or SOURCE 2 as your preferred source.

This source is now monitored as the preferred source throughout the various configurations set up through the touch screen.

5. Verify that the correct source is designated as the preferred source and that the input source changes to the desired source.

The Mimic is updated to indicate the new preferred source. The source is now highlighted with blue and that source is labeled as the preferred source.

If the Transfer Inhibit message is displayed, check for alarm messages on the Active Status window. Correct alarm conditions before attempting a source transfer.



NOTE

The preferred source may also be changed via the optional Remote Source Selection option, thereby initiating a transfer remotely

10.3 Enabling Remote Source Selection

If your system is equipped with the optional Remote Source Selection option, it must be enabled.

From the Color Graphical Display:

1. Select CONFIG from the menu bar.
2. Select SYSTEM SETTINGS from the Configuration menu.
3. Select SYSTEM OPTIONS from the System Settings menu.
4. Select YES for the REMOTE SOURCE SELECT choice.

10.4 Maintenance Bypass

The STS2/PDU is equipped with two key-interlocked, bypass breakers, CB4 and CB5, to allow manual bypass of the switch electronics for either input source in the event of switch failure or for maintenance of the switch. Refer to **Figure 3**. While operating on maintenance bypass, all voltages are removed from the static transfer switch electronics to facilitate safe repair, without de-energizing the load using a make-before-break switching sequence.

However, the unit can be bypassed using a make-before-break switching sequence only to the same source to which that the switch is connected, as indicated by the highlighted static transfer switch box on the Mimic screen.

In the event of source or switch failure, the unit should be bypassed only to the current input source. For convenience, instructions for the bypass procedure can be displayed on the touch screen by selecting the BYP. PROC option from the menu bar.

The Mimic is used to verify the status of the unit during the bypass procedures. In the unlikely event that the Color Graphical Display is not available, open the front door and look through the slots in the control door. If you can see green LEDs on the gate driver board through that slot, then the unit is connected to the source referenced on the label below that slot. See **Figure 61**.

Figure 61 Gate board viewing slot locations

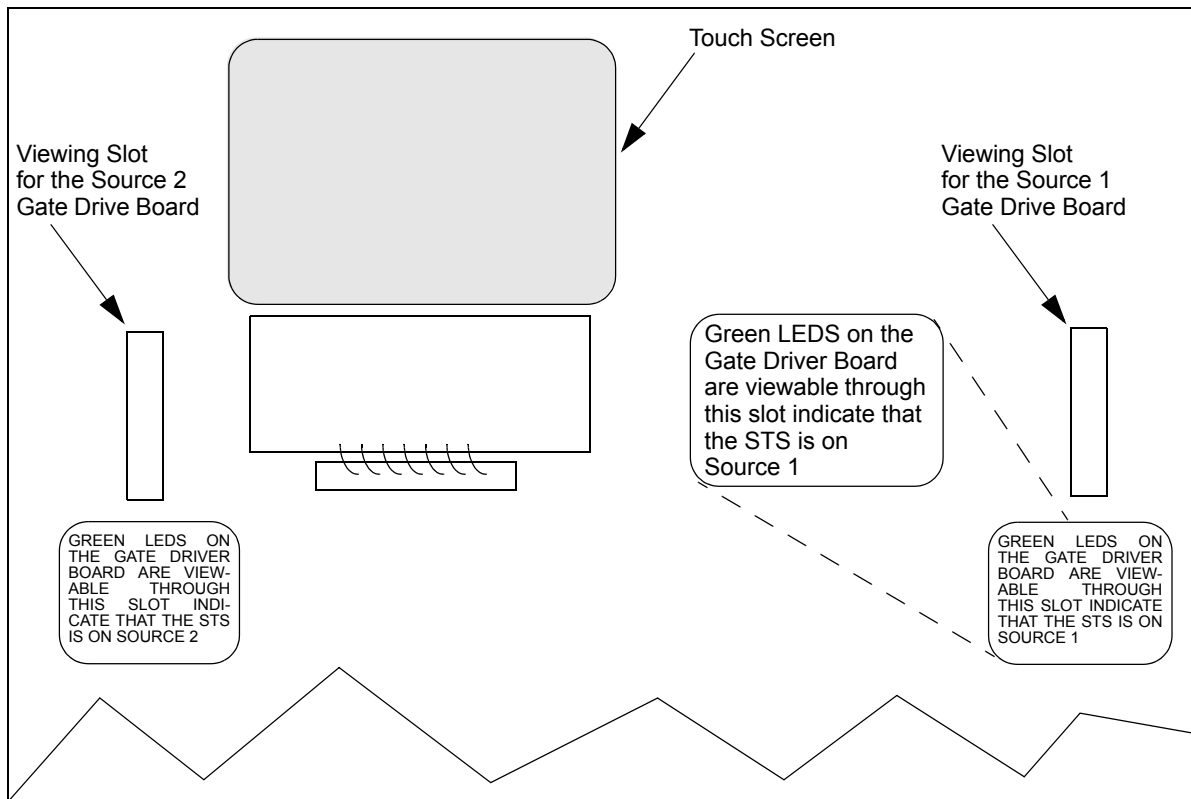

10.4.1 Bypass Procedures for Source 1

To bypass the switch for Source 1:

**NOTE**

If you wish to bypass the Source 1 static transfer switch but Source 2 is presently active, you must first transfer to Source 1. See 10.2 - Manual Transfer / Preferred Source Selection.

1. Verify Source 1 is supplying power via the Mimic.
 - If the Color Graphical Display is not available, check the gate driver board LEDs through the slots in the control panel. See **Figure 61**.
2. Remove interlock key from CB5 and place it in the CB4 interlock.
3. Open the alternate source input breaker CB2.
4. Rotate and remove the interlock key.
5. Insert the key in the CB4 bypass breaker interlock.
6. Rotate interlock keys in CB4 bypass breaker interlock to retract interlock.
7. Close bypass breaker CB4.
8. Verify the breaker status on the Mimic screen.
9. Open source input breaker CB1.
10. Rotate the interlock key and remove it to lockout the breaker.
11. Secure the key, per your site's lockout/tagout procedure.
12. Open output breakers CB3 and CB3A (if supplied) to remove power from static switch.

To return to the normal mode:

1. Remove the key from CB5 and insert it in the CB1 breaker interlock.
2. Rotate key to retract interlock.
3. Close source input breaker CB1.
4. Verify the Source 1 and CB1 breaker status on the Mimic screen.
5. Close output breakers CB3 and CB3A (if supplied).
6. Verify CB3 and CB3A breaker status and STS SOURCE 1 and OUTPUT boxes are highlighted on the Mimic screen.
7. Open bypass breaker CB4.
8. Rotate the keys in CB4 interlock to extend the interlock.
9. Remove the proper key from CB4 interlock and insert it into CB2 breaker interlock.
10. Rotate the key to retract the CB2 breaker interlock.
11. Close source input breaker CB2.
12. Verify the STS SOURCE 2 box and CB2 breaker status on the Mimic screen.
 - If the Color Graphical Display is not available, check the gate driver board LEDs through the slots in the control panel. See **Figure 61**.

10.4.2 Bypass Procedures for Source 2

To bypass the switch for Source 2:



NOTE

If you wish to bypass the Source 2 static transfer switch but Source 1 is presently active, you must first transfer to Source 2. See 10.2 - Manual Transfer / Preferred Source Selection.

1. Verify Source 2 is supplying power via the Mimic.
 - If the Color Graphical Display is not available, check the gate driver board LEDs through the slots in the control panel. See **Figure 61**.
2. Remove the interlock key from CB4 and place it in CB5 interlock.
3. Open the alternate source input breaker CB1.
4. Rotate and remove the interlock key.
5. Insert the key in the CB5 bypass breaker interlock.
6. Rotate interlock keys in the CB5 bypass breaker interlock to retract the interlock.
7. Close bypass breaker CB5.
8. Verify the breaker status on the Mimic screen.
9. Open source input breaker CB2.
10. Rotate the interlock key and remove it to lockout the breaker.
11. Secure the key, per your site's lockout/tagout procedure.
12. Open output breakers CB3 and CB3A (if supplied) to remove power from static switch.

To return to normal mode:

1. Insert the key in the CB2 breaker interlock.
2. Rotate the key to retract the interlock.
3. Close source input breaker CB2.
4. Verify Source 2 and CB2 breaker status on the Mimic screen.
5. Close output breakers CB3 and CB3A (if supplied).
6. Verify CB3 and CB3A breaker status and STS SOURCE 2 and OUTPUT boxes are highlighted on the Mimic screen.
7. Open bypass breaker CB5.
8. Rotate the keys in CB5 interlock to extend the interlock.
9. Remove the proper key from CB5 interlock and insert it into CB1 breaker interlock.
10. Rotate the key to retract the CB1 breaker interlock.
11. Close source input breaker CB1.
12. Verify the STS SOURCE 1 box and CB1 breaker status on the Mimic screen.
 - If the Color Graphical Display is not available, check the gate driver board LEDs through the slots in the control panel. See **Figure 61**.

10.5 Normal System Shutdown

The STS2/PDU can be shut down from either the static switch mode or the bypass mode.

10.5.1 Shutdown in Static Transfer Switch Mode

When the STS2/PDU is operating on static transfer switch mode (not maintenance bypass mode):

1. Turn off the load equipment per manufacturer's recommendations.
2. Open CB8 or panelboard breakers and mains if supplied
3. Open CB3 to turn off the static switch output.
 - Open CB3A if the Static Transfer Switch 2 Power Distribution Unit has a redundant output configuration.
4. Open the input switches CB1 and CB2.
5. To completely de-energize the unit, open CB6 and CB7.

10.5.2 Shutdown in Maintenance Bypass Mode

When the Static Transfer Switch 2 Power Distribution Unit is operating on bypass:

1. Turn off the load equipment per manufacturer's recommendations.
2. Open CB8 or panelboard breakers and main if supplied
3. Open the bypass switch (CB4 or CB5) to turn off the static transfer switch output.
4. To completely de-energize the unit, turn open CB6 and CB7.

11.0 ALARMS AND FAULTS

Alarms and faults are events that are triggered when the operation of the Static Transfer Switch 2 Power Distribution Unit falls outside of the defined parameters. These events can also be triggered by: user actions, such as changing configurations, clearing logs, etc.; failed components such as a fan failure, an SCR that is open or shorted, etc.; and system status, such as open circuit breakers, load on alternate source, etc. These events can provide a warning or trigger the system to make a change, such as switch sources or the recording of a history log.

The STS2/PDU monitoring system detects and annunciates a comprehensive set of fault and alarm conditions. Faults and alarm messages are can be viewed on the LCD touch screen or via the RS-232 port.

On the LCD touch screen, the events are shown in the Status Display panel in the lower left corner of the touch screen and written to the Event log. You can touch a message to view a definition of an event and a tip for troubleshooting. See **13.0 - Touch Screen Display** for more information about the touch screen.

If you are monitoring the system through the RS-232 port, see **Table 13** for the commands to view event logs and alarm and fault lists.

Event actions can be triggered by the settings configured from the Event Masks. See **11.1 - Event Mask** for more information.

Faults — A fault indicates that a component of the STS2/PDU has failed or has been damaged. In the Event Display, faults are indicated in red.

Alarms — An alarm is an event caused by a significant abnormal system condition. In the Event Display, alarms are indicated in yellow. The setpoints for many of the alarms are configurable through the User Settings. Many alarms clear themselves when the condition is resolved. If an alarm event mask is set to latch, the alarm messages remain active until the alarm condition has been corrected and the RESET button is pushed. See **11.1 - Event Mask** for more information on latching.

When the system is furnished with an optional internal or external modem and a telephone line is connected to the modem, the system can be programmed to automatically dial out upon occurrence of any of certain designated alarms. The auto-dial feature can be configured for alarms using the Event Mask option in the touch screen. See **Configuring the Modem on page 105** for instructions on for setting up your modem.

11.1 Event Mask

The STS2/PDU gathers, processes and reports faults and alarms, collectively referred to below as events. The Event Mask dialog box allows you to set the system's response for specific alarms and faults that are generated.

The following mask types are available for each event:

- **Latch** — If a latch is enabled for the selected event, that event remains active even if the originating event condition clears. A latched event may only be cleared by pushing the RESET button.
- **Dial Out** — If the selected event is triggered, the system automatically calls the specified telephone numbers through the modem. For example, a page could be sent or an event could be sent to an external terminal, via the modem. See **12.0 - Communication Interfaces** for more information on configuring communications options.
- **Event Log** — The selected event is date/time stamped and recorded to the Event Log when the event is triggered.
- **Audible** — If the selected event is triggered, an audible beeper or horn is sounded by the STS2/PDU. The beeper continues while this event is active or latched or until the SILENCE button is pushed.

See **Event Masks on page 100** for instructions on setting the mask type via the touch screen display. See the **12.1.4 - Setting Event Masks with the Terminal** for instructions on configuration using the RS-232 port.

11.2 Event and History Logs

The system tracks events through the Events Log and tracks significant events through the History Logs. These logs allow you to quickly spot trends or diagnose problems that the unit may have had. Both logs are written in nonvolatile memory.

The logs can be accessed from the touch screen menu or the RS-232 port. See **13.7.1 - Logs** for more instructions on viewing the logs from the touch screen. See **Table 13** for the RS-232 interface commands used to access the logs.

11.2.1 Event Log

The events are tracked in sequence of occurrence. The sequence of occurrence is identified by date, time and frame number. The last 512 events are stored in a nonvolatile memory and can be viewed from the Event Log.

Event logs wrap, meaning when the log is full, the oldest event is deleted when a new event is written to the log.

The Event Log tracks:

- # — the sequence number in which the event occurred since the log was last cleared.
- Message — the event that occurred, such as Ambient Over temp., Source 1 Fail, etc.
- Type — either a Fault or Alarm. See **11.0 - Alarms and Faults** for further details on these events.
- ID — the event identifier.
- Date and Time — when the event occurred.
- Faults — the number of fault events logged.
- Alarms — the number of alarm events logged.
- User Alarms — the number of alarm events logged that were triggered by user-created alarms, such as those alarms created with the Input Contact Isolator settings.
- Total — the sum of all the events currently logged.

11.2.2 History Log

When a designated major alarm occurs, the History Status buffer is frozen, capturing 64 sequential frames before and after the alarm condition. When the History Status buffer is frozen, a History Log is created.

Two History Logs are available to track major alarms. This log includes the triggering event plus the surrounding events and the system voltages, currents, frequency, power, source selection and breaker positions at the time of the event. The History Log displays the 64 sequential frames, in 4-millisecond intervals, of the Present Status screens surrounding the event.

If you are viewing the log from the touch screen, the Mimic and the Event Display show the data that was present as the alarm was triggered. The data is displayed as frames are played.

The History Log allows you to replay the events leading up to the alarm and the events right after the alarm to see the status of the switch at that time and diagnose the cause of the alarm. The History Log is triggered when certain events are tripped that have the Freeze option enabled.

You can run through the frames sequentially. The sequence of the events is identified by date, time and frame number. The History Log frames are stored in a nonvolatile memory buffer that is continuously overwritten until a designated fault condition occurs. When the fault occurs to trigger a freeze, the History Log stores the next 23 frames, then freezes until it is reset. The History Log then keeps 40 frames before the fault, the frame where the fault occurred, plus the next 23 frames.

The History Log should not be reset until the fault condition that caused the buffer to freeze is reviewed and investigated by a qualified service technician. After the alarm condition has been corrected, the History Log can be cleared.

The History Log has the following fields:

- **Replay Rate** — indicates how long it takes for the replay to play. Use the UP and DOWN buttons to set the time.
- **Status** — the status of the STS2/PDU at the point of the current frame in the replay. The History log has three statuses: Frozen, Not Frozen and Retrieving Data, please stand by.
- **Critical Event** — The event which triggered this log to be written. The event is indicated in red on the bar graph.
- **Frame Number** — the current frame in the replay. A negative number indicates the replay is at a point before the triggering event occurred.

11.3 Alarm Notes

The I-PK on Source 1 and I-PK on Source 2 alarms inhibit automatic transfer due to an overload or load fault. These alarms can be set for either auto or manual alarm reset.

In the auto reset mode, the alarm is reset as soon as the load current and source voltage return to are inhibited until the conditions return to normal and the user manually presses the RESET button. In either case, the cause of the Source 1 or Source 2 Ipeak overload should be investigated and resolved (such as by reducing the overload condition or clearing the output fault) before returning the switch to normal operation.

These events indicate a device failure. The device must be replaced and the system must be restarted for the fault to clear. A shorted SCR automatically trips open a source input switch (CB1 or CB2) to prevent transfers in the event of an SCR failure. The SCR failure must be investigated and repaired before returning the switch to normal operation. Both source input switches must be opened (such as when the unit is placed in maintenance bypass for servicing) before a shorted or open SCR alarm can be reset.

11.4 List of Messages

Table 12 lists available event messages, a definition of the event and the functions that are activated with the event by default. The functions are indicated as follows:

- D** — The indicated event initiates the **Auto-Dial** sequence through the optional modem.
- A** — The indicated event activates the **Audible** alarm.
- F** — The indicated event triggers a **Freeze** of the History Log.
- L** — The indicated event **Latches**. A latched alarm remains displayed until the alarm condition has cleared and the RESET button has been pressed.
- E** — By default, all faults and alarms are written to the Event Log. See **12.1.4 - Setting Event Masks with the Terminal**.

All of these functions, except Freeze, can be reconfigured to trigger for each event, using the Event Mask option. See **11.1 - Event Mask**. The Freeze function is hard-coded and cannot be changed for a event.

Table 12 Event messages

| ID | Alarm Message | Description/Cause | Action |
|----|---------------------|---|------------|
| 1 | S1 SCR SHORT | One or more of the SCRs for Source 1 have shorted and failed. | D, F, A, E |
| 2 | S2 SCR SHORT | One or more of the SCRs for Source 2 have shorted and failed. | D, F, A, E |
| 3 | S1 SCR OPEN | One or more of the SCRs for Source 1 is open. | D, F, A, E |
| 4 | S2 SCR OPEN | One or more of the SCRs for Source 2 is open. | D, F, A, E |
| 5 | PRIMARY FAN FAIL | A primary cooling fan has failed and the unit is now being cooled by a secondary fan, which is not monitored. | D, A, E |
| 6 | CONTROL MODULE FAIL | Control logic module has failed. | D, A, E |
| 7 | PWR SPLY DC A FAIL | Power supply DC bus A has failed. | D, A, E |
| 8 | PWR SPLY DC B FAIL | Power supply DC bus B has failed. | D, A, E |
| 9 | PWR SPLY S1 AC FAIL | Power supply Source 1 AC has failed. | D, A, E |
| 10 | PWR SPLY S2 AC FAIL | Power supply Source 2 AC has failed. | D, A, E |
| 11 | PWR SPLY LOGIC FAIL | A power supply module has failed. | D, A, E |
| 12 | OUT VOLT SENSE FAIL | The output volt sense module failed | D, A, E |
| 13 | S1 VOLT SENSE FAIL | The Source 1 volt sense module failed. | D, A, E |
| 14 | S2 VOLT SENSE FAIL | The Source 2 volt sense module failed. | D, A, E |
| 15 | S1 SCR SENSE FAIL | The Source 1 SCR sense module failed. | D, A, E |
| 16 | S2 SCR SENSE FAIL | The Source 2 SCR sense module failed. | D, A, E |
| 17 | S1 CURR SENSE FAIL | The Source 1 SCR current module failed. | D, A, E |
| 18 | S2 CURR SENSE FAIL | The Source 2 SCR current module failed. | D, A, E |
| 19 | S1 GATE DRIVE FAIL | The Source 1 gate drive module failed. | D, A, E |
| 20 | S2 GATE DRIVE FAIL | The Source 2 gate drive module failed. | D, A, E |
| 21 | INTERNAL COMM FAIL | Internal CAN communications failed. | D, A, E |
| 23 | CB1 SHUNT TRIP FAIL | CB1 shunt trip failed. | D, A, E |
| 24 | CB2 SHUNT TRIP FAIL | CB2 shunt trip failed. | D, A, E |
| 27 | EQUIPMENT FAN FAIL | One of the equipment fans failed | D, A, E |
| 28 | INPUT 1 SURGE FAIL | Source 1 input surge suppression module failed | D, A, E |
| 29 | INPUT 2 SURGE FAIL | Source 2 input surge suppression module failed | D, A, E |
| 64 | HEATSINK OVERTEMP | Heatsink has exceeded the recommended temperature. | A, E |
| 65 | EQUIPMENT OVERTEMP | Cabinet has exceeded the recommended temperature | A, E |
| 67 | S1 UV | Source 1 under voltage, fast detection. | A, E |
| 68 | S1 UV (RMS) | Source 1 under voltage, slow detection. | A, E |
| 69 | S1 OV | Source 1 over voltage | A, E |
| 70 | S1 OF/UF | Source 1 over frequency/under frequency | A, E |
| 71 | S1 FAIL | Source 1 failure. | A, E |
| 72 | S2 UV | Source 2 under voltage, fast detection. | A, E |
| 73 | S2 UV (RMS) | Source 2 under voltage, slow detection. | A, E |
| 74 | S2 OV | Source 2 over voltage. | A, E |
| 75 | S2 OF/UF | Source 2 over frequency/under frequency. | A, E |
| 76 | S2 FAIL | Source 2 failure. | A, E |
| 77 | S1 OVERCURRENT | Source 1 over current. | A, E |
| 78 | S2 OVERCURRENT | Source 2 over current. | A, E |
| 79 | S1 I-PEAK | I-PK on Source 1. | D, F, A, E |
| 80 | S2 I-PEAK | I-PK on Source 2. | D, F, A, E |

Table 12 Event messages (continued)

| ID | Alarm Message | Description/Cause | Action |
|--|--|---|------------|
| 81 | SOURCES OUT OF SYNC | Source 1 and Source 2 are out of synchronization. | A, E |
| 82 | LOAD ON ALT SOURCE | The output load is running on the alternate source. | A, E |
| 83 | AUTO REXFER INHIBIT | Automatic retransfer is inhibited. | A, E |
| 84 | CB1 (S1) OPEN | Source 1, Circuit Breaker 1 is open. | A, E |
| 85 | CB2 (S2) OPEN | Source 2, Circuit Breaker 2 is open. | A, E |
| 86 | CB4 (S1 BYP) CLOSED | Source 1 on bypass, Circuit Breaker 4 is closed. | A, E |
| 87 | CB5 (S2 BYP) CLOSED | Source 2 on bypass, Circuit Breaker 5 is closed. | A, E |
| 88 | CB3 (OUTPUT) OPEN | Output circuit breaker (CB3) is open. | A, E |
| 89 | CB3A (OUTPUT) OPEN | Output circuit breaker (CB3A) is open. | A, E |
| 90 | S1 PHASE ROT ERROR | Source 1 phase rotation error. | A, E |
| 91 | S2 PHASE ROT ERROR | Source 2 phase rotation error. | A, E |
| 92 | TRANSFER INHIBITED | Transfer inhibited. | A, E |
| 93 | OUTPUT UV | Output is under voltage. | D, F, A, E |
| 94 | HISTORY LOG FULL | Both History Logs have been written and no more history logs can be written without clearing one of the logs | A, E |
| 96 | INPUT 1 OV INPUT | Source 1 over voltage | A, E |
| 97 | INPUT 1 UV INPUT | Source 1 under voltage | A, E |
| 98 | INPUT 2 OV INPUT | Source 2 over voltage | A, E |
| 99 | INPUT 2 UV INPUT | Source 2 under voltage | A, E |
| 100 | LOAD OVERCURRENT | Output over current | A, E |
| 101 | GROUND OVERCURRENT | Ground over current | A, E |
| 102 | NEUTRAL OVERCURRENT | Neutral over current | A, E |
| 103 | LOAD VOLTAGE THD | Voltage THD has exceeded the set limit | A, E |
| 104 | INPUT 1 CB6 OPEN | Source 1 input Circuit Breaker 6 is open | A, E |
| 105 | INPUT 2 CB7 OPEN | Source 2 Input Circuit Breaker 7 is open | A, E |
| 106 | INPUT 1 OF/UF | Source 1 over frequency/under frequency | A, E |
| 107 | INPUT 2 OF/UF | Source 2 over frequency/under frequency | A, E |
| 120 121 122 123 124 125 126 127 | INPUT CONTACT #1 INPUT CONTACT #2 INPUT CONTACT #3 INPUT CONTACT #4 INPUT CONTACT #5 INPUT CONTACT #6 INPUT CONTACT #7 INPUT CONTACT #8 | Input Contact # x is an optional alarm input. The alarm name can be programmed with an alarm name from the Input Contactor Isolator settings option under the Comm Options. See Configuring the Input Contact Isolator Settings on page 108 . The alarm is sent to Monitor DSP. The LCD logs the alarm with the programmed name. Monitor DSP logs it with the generic name which is how it is reported to the SVT query. | A, E |
| 128 | CONFIG MODIFIED | A setpoint configuration has changed. | E |
| 129 | PASSWORD CHANGED | The password for touch screen access has been modified and saved. | E |
| 130 | TIME REPROGRAMMED | The system's time has been reset and saved. | E |
| 131 | DATE REPROGRAMMED | The system's date has been reset and saved. | E |
| 132 | EVENT LOG CLEARED | The event log has been erased. | E |
| 133 | HIST LOGS CLEARED | Both History Logs have been erased. | E |
| 134 | XFER COUNT CLEARED | Transfer counter reset to 0 | E |
| 135 | KWH COUNT CLEARED | KW-Hrs counter reset to 0 | E |

12.0 COMMUNICATION INTERFACES

The STS2/PDU monitoring system offers several choices for communications.

The RS-232 terminal port is standard on all units. The port is inside the front door, to the left of the touch screen front panel mounting as shown in **Figure 55**. This port is primarily used as an alternate user interface to configure, control and diagnose the system. Commands for the RS-232 port are shown in **Table 13**.

Several other communications options are also available. Those options are located a Communications compartment. See **Figures 47** and **48** for the location of the communications options.

Connections to the communication ports are made by wiring to terminal boards located in the Communications compartment. The communications options listed below reference the control wiring drawing for each option.

- Internal modem (optional) — the connection to this modem is through a standard RJ-11 port. This port automatically dials the programmed telephone number when a designated alarm occurs. Automatic dial attempts are made to the first phone number at periodic intervals for 30 minutes. After that time, auto dial attempts are made to the second phone number at periodic intervals for the next 30 minutes. The process is repeated until a successful connection is made. Upon successful connection, the system transmits the status information and then hangs up. System status and history information can be requested and date and time can be changed through the modem. The modem commands are shown in **Table 13**. See **Figure 53** for more information on the internal modem.
- Network Interface Card (NIC) (optional) — the NIC provides connectivity to any TCP/IP-based Ethernet network to allow the device to communicate with network management systems (NMS) via SNMP. Events can be transmitted to the NMS to provide remote status monitoring, plus fault and alarm detection. The NIC includes an RJ-45 port for an Ethernet connection, via Category 5 cable. The NIC can also integrate the system with an existing Building Management System (BMS) or out-of-band monitoring, using Modbus, a standard multi-drop protocol. The NIC has redundant communication paths that make it possible to connect to a BMS using Modbus while simultaneously communicate to a NMS through SNMP. See **Figure 54** for more information on the NIC. If you have questions about the NIC, refer to the OpenComms Network Interface Card installation and user guide.
- Input Contact Isolator (ICI) Board (optional) — provides an interface for up to eight user inputs. External messages and alarms can be routed to the unit, via the ICI. See **Configuring the Input Contact Isolator Settings on page 108** for instructions on configuring the connections. See **Figure 51** for wiring details.
- Programmable relay board (PRB) (optional) — up to two PRBs can be installed in the STS2/PDU to route STS2/PDU events to external devices. See **Configuring the Programmable Relay Board Settings on page 109** for default settings and instructions for reconfiguring the relays. See **Figure 50** for wiring details.
- Comms Board (optional) — includes a terminal block to provide a DTE connection to an external modem. This board also provides a direct connection to a SiteScan terminal, via an RS-422. SiteLink-12 or SiteLink-4 is required for SiteScan to communicate with the STS2/PDU. See **Figure 52** for wiring details.

Data link requirements are Full Duplex Asynchronous RS-232 format.

Communications options are also discussed in **6.0 - Options**.

12.1 Using the RS-232 Port

The RS-232 port is configured with a baud rate of 9600 with 8 Data Bits, 1 Stop Bit, No Parity and no hardware handshaking.

12.1.1 Connecting and Using a Terminal

An RS-232 connection can be used to connect the STS2/PDU to either a terminal or a PC running terminal emulation software. If you are unsure of the cable pin out, see **14.2.10 - Terminal Port Connections**.

1. Connect the terminal to the STS2/PDU by plugging the cable from the terminal into the RS-232 port. This connection can be made at any time.
2. After making the connection, verify the communications link by pressing <ENTER> on the terminal keyboard.

The interface communications system responds as indicated below:

Repeating command -->

Illegal command!

<?> or <HELP?> displays the RS-232 command set

<?> <command> or <HELP?> <command> displays specific help for the command SVTP-Control>

The SVTP-Control > prompt indicates that RS-232 communications are established.

- If you receive no response or prompt, verify that the connector is properly plugged into the port and the PC or terminal serial interface is working properly.
3. Enter the desired commands, as listed in **Table 13**.

For additional help type <?> <command> or <HELP?> <command>

Refer to the corresponding menu options in **13.0 - Touch Screen Display** for more details about the commands.

Some terminal commands require a password to function. Use the PWD command and a valid password to gain access.

Table 13 Terminal commands

| Keys | Function |
|--------|--|
| ? | Displays this help menu or specific help with a command |
| AA? | Displays active alarms |
| AF? | Displays active faults |
| CEL | Clears the event log |
| CHL | Clears the history logs |
| DATE? | Displays current system date |
| DATE | Sets system date |
| EL? | Displays the entire event log |
| HELP? | Displays this help menu or specific help with a command |
| HLn? | Displays the history log #n, if frozen |
| LOGOUT | Logs user out of unprotected mode |
| PS? | Displays the preferred source |
| PS n | Sets the preferred source to #n |
| PWD | Allows users to access protected commands |
| QUIT | Modem only. Ends the session and hangs up the modem. |
| SH | Silences the horn |
| SPT? | Displays all current setpoints |
| SPTx | Displays current setpoints for group x. See 12.1.2 - Configuring the STS2/PDU via the Terminal for a description of groups. |
| SR? | Displays status reports |
| TIME? | Displays current system time |
| TIME | Sets system time |
| UPMDR? | Displays metering data |
| VER? | Displays firmware versions |

12.1.2 Configuring the STS2/PDU via the Terminal

The SPT command is used to configure the systems setpoints. The SVT syntax for the setpoints consists for four parameters:

SPT [group] [item] [value] where the parameters are:

- SPT — is the terminal command that is used to configure setpoints.
- group — the group under the setpoint command which contains the desired settings.
- item — the item number within the selected group.
- value — the desired value for this item.

Only the specific options words listed in this section use a hexadecimal value. Other settings, depending on what they are, use other input types. For example, System ID uses a text string; nominal voltages and currents use standard numeric integers; and modem baud rate uses an enumeration where

0 = 2400, 1 = 9600, & 2 = 19200 bps.



NOTE

Spaces are placed between each parameter, but not between characters or numbers in a parameter. Using an underline here to represent a space, an example of a the syntax is: SPT_2_6_0081. The value parameter is 0081.

This section provides instructions for setting these parameters, with an example of building an SPT command for System and User settings.

Groups Parameter

The setpoints are grouped for ease of configuration. For example, Event Masks are group 4 and System Settings are group 2. The numbers shown below are entered for the group parameter. For example, start of a System Settings command is SPT 2.

The group parameters are:

- 1 = System Ratings
- 2 = System Settings
- 3 = User Settings
- 4 = Event Mask Settings

For example, the start of a System Settings command is SPT 2, where SPT is the system setpoints command and 2 is the group parameter for System Settings.

See **12.1.4 - Setting Event Masks with the Terminal** for instructions on configuring Event Mask parameters.

Item Parameter

Each setting within the group is indexed by an item number as shown below in **Table 15**. These item numbers are also displayed on the terminal when you list the configuration setting for a particular group.

Continuing with the example, to configure an Options_1 setting under System Settings, the command would begin with SPT 2 6 where 6 is the value Options_1. Note the space between each parameter.

Value Parameter

Item settings, depending on what they are, use various value types. **Table 14** provides a list of the possible value types and their description.

Table 14 Value types

| Type | Definition |
|-------------|---|
| Numeric | An integer numeric value in the units indicated by the item name. For example, a System Voltage Rating of <i>480</i> would indicate <i>480 volts</i> . |
| Scaled | Similar to the Numeric, this value type is an integer that has been scaled, usually to remove decimal points that would normally appear within the value. In this case, a value of <i>2.5</i> may actually be input as simply <i>25</i> . For all Scaled types, the scaling appears in Table 15 . |
| String | Certain settings are represented by alphanumeric character strings, such as setting the System Model Number to <i>ProductName</i> . |
| Enumeration | This type uses an indexed list to represent possible choices. One example is the Modem Baud Rate which uses a value of <i>0</i> to select 2400 bps, <i>1</i> for 9600 bps and <i>2</i> for 19200 bps. |
| Bit-packed | This type of value uses a <i>hexadecimal binary word</i> , where each of the sixteen <i>bits</i> in the word has the value of <i>1 (True)</i> or <i>0 (False)</i> . Although somewhat difficult to use, it packs a large amount of data within a single entry. A detailed description of this type appears in section 12.1.3 - Setting Bitpacked Options With the Terminal . |
| Event Masks | This type is a specially formatted and is used to customize the behavior of each fault and alarm in the system. See 12.1.4 - Setting Event Masks with the Terminal for instructions on configuring Event Mask parameters. |

Table 15 shows the various groups, the settings contained within and the type of value it requires.

Table 15 Group settings and values

| Group | Item: | Description | Value Type | Value Notes |
|---|-----------|-------------------------------------|-------------|-------------------------------------|
| Group 1: System Ratings | 1 | Input Volts (PDU) | Integer | Set per system spec. |
| | 2 | Volts | Integer | Set per system spec. |
| | 3 | Current | Integer | Set per system spec. |
| | 4 | Frequency | Scaled | Desired freq. x 10 (600 = 60 Hz) |
| Group 2: System Settings | 1 | Language | Enumeration | [Not supported at this time] |
| | 2 | System Model Number | String | 14 Character max. |
| | 3 | System ID Number | String | 8 Character max. |
| | 4 | System Tag Number | String | 8 Character max. |
| | 5 | System Order Number | String | 8 Character max. |
| | 6 | Options_1 | Bitpacked | 14 Character max. |
| | 7 | Autodial Primary Line | String | 20 Character max. |
| | 8 | Autodial Secondary Line | String | 20 Character max. |
| | 9 | Autodial Pager Number | String | 20 Character max. |
| | 10 | Autodial Pager PIN | String | 10 Character max. |
| | 11 | Modem Init String | String | 20 Character max. |
| | 12 | Modem Baud Rate | Enumeration | 0 = 2400, 1 = 9600, & 2 = 19200 bps |
| | 13 | Modem LGS Check - Day | Bitpacked | |
| | 14 | Modem LGS Check - Time | Bitpacked | |
| | 15 | Comms Options 1 | Bitpacked | See section 12.1.3. |
| | 16 | Comms Options 2 | Bitpacked | See section 12.1.3. |
| Group 3: User Settings | 1 | SRC1 Fast Undervoltage Setpoint | Integer | In % of nominal below nominal |
| | 2 | SRC1 Slow Undervoltage Setpoint | Integer | In % of nominal below nominal |
| | 3 | SRC1 Slow Undervoltage Detect Delay | Integer | In number of lines cycles |
| | 4 | SRC1 Overvoltage Setpoint | Integer | In % of nominal above nominal |
| | 5 | SRC1 Overvoltage Detect Delay | Integer | In 1/4 lines cycles |
| | 6 | SRC1 I peak Transfer Setpoint | Integer | x 10 |
| | 7 | SRC2 Fast Undervoltage Setpoint | Integer | In % of nominal below nominal |
| | 8 | SRC2 Slow Undervoltage Setpoint | Integer | In % of nominal below nominal |
| | 9 | SRC2 Slow Undervoltage Detect Delay | Integer | In number of lines cycles |
| | 10 | SRC2 Overvoltage Setpoint | Integer | In % of nominal above nominal |
| | 11 | SRC2 Overvoltage Detect Delay | Integer | In 1/4 lines cycles |
| | 12 | SRC2 I peak Transfer Setpoint | Integer | x 10 |
| | 13 | Max. Transfer Phase Angle | Integer | In degrees |
| | 14 | Output Frequency Deviation | Integer | Freq. in Hz x 10 |
| | 15 | ReTransfer Delay Time | Integer | In seconds |
| | 16 | Horn Volume | Integer | Range: 1-10 |
| | 17 | Critical Option Enabling | Bitpacked | See section 12.1.3. |
| | 18 | Non-Critical Option Enabling | Bitpacked | See section 12.1.3. |
| Group 4: Event Mask Settings | 1 to 63 | Event Mask settings for faults | Event Mask | See section 12.1.3. |
| | 64 to 143 | Event Mask settings for alarms | Event Mask | See section 12.1.3. |

12.1.3 Setting Bitpacked Options With the Terminal

Five sets of options and features settings are available through the terminal to control the system operation.

Under System Settings for the SPT command, these items denote which options are INSTALLED:

- 6 — Options_1
- 14 — Comms Options 1
- 15 — Comms Options 2

Under User Settings, for the SPT command, these items denote which features are ENABLED:

- 17 — Critical Option Enabling
- 18 — Non-Critical Option Enabling

The value parameter settings are in the form of a bit-packed word (in hexadecimal notation). In other words, each bit indicates a particular setting for the option or feature. The bit assignments for the options and features are as follows:

Options_1

- bit0 — HasDualOutputBreaker
- bit1 — HasPDU
- bit2 — Has4PoleTransferSwitch
- bit3 — HasShuntTrip
- bit4 — HasWyeOutputXfmr
- bit5 — HasExternalPrecisionTimeSource
- bit6 — HasSFA
- bit7 — HasRemoteSourceSelect
- bit8 through bit15 — not used (set to 0)

Comms Options 1

- bit0 — HasIntModem
- bit1 — HasExtModem
- bit2 — HasNIC
- bit3 — not used (set to 0)
- bit4 — HasSiteScan
- bit5 — not used (set to 0)
- bit6 — not used (set to 0)
- bit7 — HasOpenCommsDigitalInputBrd
- bit8 — HasOpenCommsDigitalOutputBrd_1
- bit9 — HasOpenCommsDigitalOutputBrd_2
- bit10 — HasRemoteStatusPanelBrd_1
- bit11 — not used (set to 0)
- bit12 — not used (set to 0)
- bit13 — not used (set to 0)
- bit14 — EnableDialIn
- bit15 — EnableDialOut

Comms Options 2

- bit0 — EnablePager
- bit1 — EnableOCDINormallyClosed
- bit2-3 — OCDO1Assignment (0=User Defined, 1=Standard Set or 2=AS400)
- bit4-5 — OCDO2Assignment (0=User Defined, 1=Standard Set or 2=AS400)
- bit6 through bit15 — not used (set to 0)

Critical Option Enabling

- bit0—EnableManual_IPeakReset
- bit1—EnableAutoRestart
- bit2 through bit15 - not used (set to 0)

Non-Critical Option Enab

- bit0 — EnableAutoReXfer
- bit1 through bit15 — not used (set to 0)

The bits are set in reverse order, from bit 15 on the left to bit 0 (zero) on the right. The bits are grouped in four sets of four bits each, as such:

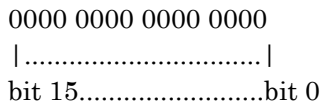

Since each bit represents a setting, a bit can be enabled or disabled:

- 1 = installed option or enabled feature
- OR
- 0 = option not installed or feature not enabled

Enabling or disabling the bits in each group creates a binary value for that group. For example, if the fourth bit in a group is set to 1, the group’s binary value is 0001.

Each group is translated into a hexadecimal equivalent. The group with the value of 0001 has a hex equivalent of 1.

You can use **Table 16** below to help with the conversion.

Table 16 Binary-hexadecimal conversions

| Binary Value | Hex Equivalent |
|--------------|----------------|
| 0000 | 0 |
| 0001 | 1 |
| 0010 | 2 |
| 0011 | 3 |
| 0100 | 4 |
| 0101 | 5 |
| 0110 | 6 |
| 0111 | 7 |
| 1000 | 8 |
| 1001 | 9 |
| 1010 | A |
| 1011 | B |
| 1100 | C |
| 1101 | D |
| 1110 | E |
| 1111 | F |

The hex value for each group is entered in the command as four digits.

To summarize the procedure:

1. Set each bit position.
2. Convert the binary value each group into its hex equivalent.
3. Enter the hex values for each group, in order, into the command for the value parameter.

The following example explains how the conversion is completed.

Putting the Terminal Command Together

For example, a unit only has the Remote Source Selection and Dual-Output Breaker options installed.

Checking the bits list under **Options_1 on page 92**, bits 7 and 0 each must be set to 1 to indicate that these options are installed.

The bit setting is as follows, starting with bit 15 on the left and going down to bit 0:

```
0000 0000 1000 0001
```

With the bits combined in groups of four, the binary settings can be translated into hexadecimal values.

The first two groups in the sample equal zero (0). In the third group, 1000 in binary translates to 8 in hex. In the fourth group, 0001 in binary translates to 1 in hex.

In hex, this equates to (digits in the value parameter cannot have spaces between them):

```
0081
```

So your command to indicate that the Remote Source Selection and the Dual-Output Breaker are installed would be:

```
SPT 2 6 0081
```

12.1.4 Setting Event Masks with the Terminal

The event masks can be customized via a terminal. The command `SPT4?<ENTER>` displays all faults and alarms, along with their associated event masks. A plus sign (+) means that particular event mask is enabled, while a minus sign (-) means that mask is disabled.

Refer to **11.1 - Event Mask** for more information on event masks and their associated flags.

Unlike the System and User Settings, mask values are set by designated letters, not hex values.

However, as with other RS-232 interface settings, four parameters are passed. See **12.1.2 - Configuring the STS2/PDU via the Terminal** for more details about the parameters.

The syntax for configuring event masks is:

```
SPT 4 ID ±D±L±S±E±A
```

- SPT — is the terminal command used to configure setpoints.
- 4 — setting (group parameter) for event masks, under System Settings.
- ID — event ID. The ID is the item parameter for this command. The ID numbers for each event are listed with the events in **Table 12**.
- D,L,S,E,A — the event masks: Dial, Latch, Summary, Event log and Audible. The masks are the value parameter for the command.

Each mask type must be preceded by a plus sign (+) to enable it or by a minus sign (-) to disable it.



NOTE

NO spaces are placed between each mask listed above.

Only the mask that is passed (enabled) is applied when the event occurs.

To set the event masks for a particular event:

1. Enter the command. Examples and descriptions are provided below.
2. Press ENTER.

After the new settings are entered, the new results for that event ID are displayed.

Examples of Event Mask Settings

- To latch event #001, S1 SCR SHORT, use SPT 4 1 +L.
- To disable event #128, CONFIG MODIFIED, from sounding the horn, use SPT 4 100 -A.
- To enable event #012, OUT VOLT SENSE FAIL, to Dial and go into the Event Log, use SPT 4 12 +D+E.
- To disable all masks for event #120, INPUT CONTACT #1, use SPT 4 120 -D-L-S-E-A.
- To breakdown this syntax for the last example:
- SPT — SVT command
- 4 — group parameter, identifying System Setting group under which the Event Mask settings reside.
- 120 — item parameter. In this command, that is the event ID.
- -D-L-S-E-A — value parameter. In this case, the minus sign (-) disables all masks for the INPUT CONTACT #1 event.

13.0 TOUCH SCREEN DISPLAY

The STS2/PDU can be configured with a Color Graphical LCD touch screen display that allows you to quickly check the status of the unit and identify problems.

A touch screen LCD is available through the front of the STS2/PDU. This screen provides a graphical (Mimic) display of the switch's operation, plus system information including system parameters, alarms and faults.

The LCD provides a color, back-lit touch screen as a user interface. In addition to the Mimic and the system parameters, the screen provides a series of menus to allow you to configure the STS2/PDU, including the control of the preferred source, auto/manual retransfer selection, alarm notification and other system setpoints. The touch screen also provides buttons to reset alarms and turn off audible alarms, such as a horn.

13.1 Display Overview

The STS2/PDU Color Graphical Display provides three areas of information, plus buttons and a series of menu choices.

The Color Graphical Display contains the following features:

- **Mimic** — a graphical diagram of the status of the unit.
- **Event controls** — allow you to reset alarms and turn off audible alarms.
- **Event display** — displays any active alarm or fault condition, in real-time.
- **Menus** — provide choices and configuration settings in dialog boxes or information in the display panel.
- **Display panel** — provides additional information, depending on the menu choice that was last selected. This information includes event help text and startup and bypass procedures.

Figure 62 STS2/PDU Touch Screen Display

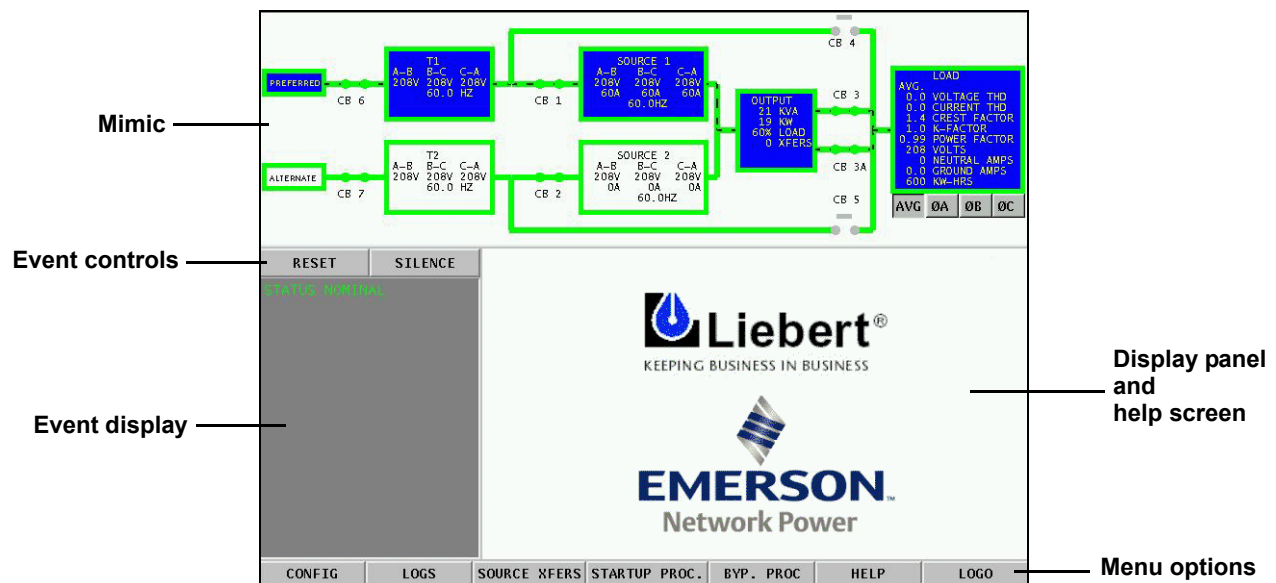

13.2 Menu Overview

The touch screen menu provides access to configuration settings and more device information.

The CONFIG (Configuration) and LOGS menus provide multiple choices through pop-up menus.

The SOURCE XFER menu selection allows you to select the preferred source. The other menu choices provide information in the display panel. The menu choices are discussed later in this manual.

All programmable functions are preset at the factory to default settings. These settings enable the unit to be brought up without the need to enter all selectable parameters. The menus allow the settings to be customized.

Figure 63 Menus

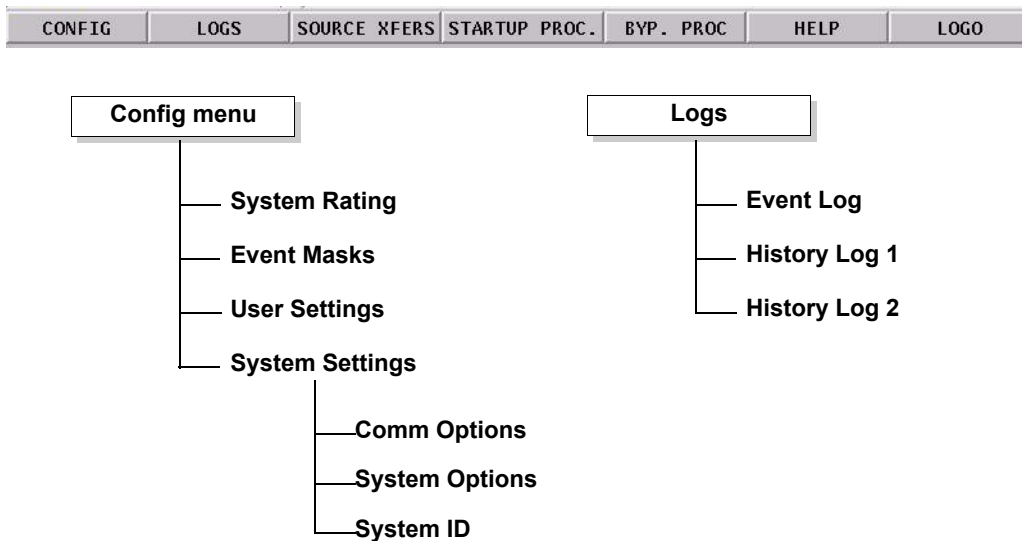

NOTE

Some menu choices display a keyboard or keypad on the touch screen. Enter data on the touch screen.

Click OK to save the data that you have entered.

Use the back arrow button (<-) to delete unwanted characters. This button functions like a backspace key on a keyboard.

Figure 64 Keyboard and keypad displays

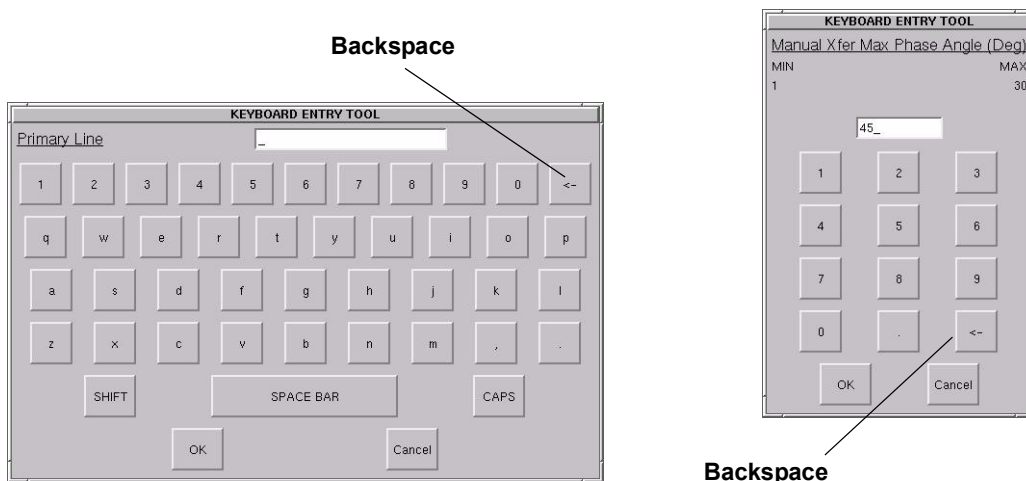

13.2.1 Security

Because the STS2/PDU Color Graphical Display provides access to various configuration and monitoring choices, a password or key lockout switch may be used to protect access to certain changes, including:

- Change configuration settings
- Clear logs
- Make a source transfer
- Reset an alarm

Without entering the password or enabling changes with the key lockout switch, you still can:

- View the display, including the mimic, status and event help
- View logs
- View the startup and bypass procedures
- Use the SILENCE button to turn off the audible alarm

Using the Optional Key Lockout Switch

An optional key lockout switch for the STS2/PDU enables or disables the ability to make changes on the STS2/PDU. The key lockout switch is located on the front of the unit next to the display; it is behind the front door but can be operated without opening the front door. See **Figures 20** through **22** for location of the key lockout switch.

- To disable the changes, turn the key to the top of the switch, toward the closed padlock.
- To enable changes turn the key to the horizontal position, toward the open padlock.

Figure 65 Key lockout switch

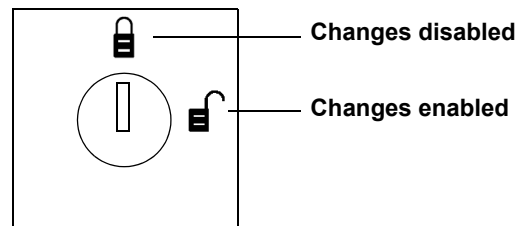

Using the Password

If the unit is not equipped with a keylock, a password is required when you attempt to:

- Save changes in the CONFIG menu choices.
- Transfer sources.
- Reset active alarms.
- Clear logs.

When a password is requested, a keyboard is displayed on the touch screen. After you enter the password, select OK.

The password is case-sensitive. Password access times out after ten (10) minutes and must be re-entered to save changes. The time-out period cannot be changed.

To set or reset the password:

1. Select SYSTEM SETTINGS from the CONFIG menu.
2. Select SYSTEM ID from the SYSTEM SETTINGS menu.
3. Click PASSWORD. A keyboard is displayed.
4. Enter a password. The password must be four (4) alpha-numeric characters and is case sensitive.
5. Click OK.

13.3 Mimic Display

The Mimic display provides a color diagram of the operation of the STS2/PDU. This display imitates the power flow through the Static Transfer Switch 2 Power Distribution Unit and indicates source status, breaker status, switch status, source voltage and current readings, output power measurements and active alarm messages. See **Figure 62**.

13.4 Event Controls

The STS 2 detects events when certain thresholds are passed or certain problems occur. The alarm controls allow you to acknowledge the existence of these events.

- **RESET** — All latched events whose conditions have cleared are removed from the Event Display. Faults and alarms that remain active or are not recoverable are not affected when this button is selected. This button is also used to perform manual I-Peak resets and manual retransfers.
- **SILENCE** — turns off the audible alarm (horn or beeper) without resetting the triggering event. This setting does not permanently turn off the horn. The alarm sounds again when the next event with an audible alarm setting is triggered.

Active events are shown in the Event Display, whereas cleared events can be reviewed via the Event Log.

13.5 Event Display

The Event Display lists the condition of the STS2/PDU in real-time. Both nominal system parameters and alarm messages are displayed in the Event Display. You can touch any message in the Event Display to display more information in the Display Panel to the left. The selected status is displayed in bold type.

13.6 Menu Bar

As previously mentioned, the menu bar provides both configuration choices and information. The choices under the Config and Log menus access additional dialog boxes, while the other menu choices only show information in the display panel.

13.7 Configuration Menu

When you select the CONFIG (Configuration) menu choice, a pop-up menu is displayed with four choices.

- **SystemRatings**— used to configure frequency, voltage and currents settings for the STS2/PDU.
 - **Event Mask** — allows you to configure system's response for events.
 - **User Settings** — allows you to configure operations for the STS2/PDU.
 - **System Settings** — accesses another pop-up menu to configure communication and system choices and the system ID.

Each of these choices accesses a separate dialog box.

System Ratings

The System Ratings menu is used to set the nominal line frequency, nominal voltage and nominal current at which the system operates when it is installed. These settings are configured when the system is initialized at the factory or under maintenance and should not be changed by the user.

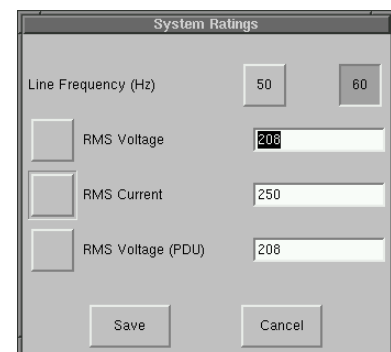

Event Masks

The STS2/PDU gathers, processes and reports faults and alarms, collectively referred to below as events. The Event Mask dialog box allows you to set the system's response for specific alarms and faults that are generated. See **11.0 - Alarms and Faults** for more information on events and **11.1 - Event Mask** for the definitions of the Event Mask types.

To set the event masks:

1. Access the Event Mask dialog box:
 - a. Select CONFIG.
 - b. Select EVENT MASK from the pop-up menu.
The Event Mask dialog box is displayed. See **Figure 66**.
2. Select the mask settings for each fault and alarm.
 - a. Select YES to enable the setting,
OR
 - b. Select NO to disable the setting.
3. Select SAVE to keep the settings.

Figure 66 Event Mask dialog box

The screenshot shows the 'Event Masks' dialog box. It has a title bar 'Event Masks' and a header row with columns: 'Alarm / Fault Name', 'Latch', 'Dial Out', 'Event Log', and 'Audible'. Below the header, there is a section titled 'FAULTS' in red. The table contains five rows of faults, each with four buttons for 'NO', 'YES', 'YES', and 'YES' respectively. At the bottom of the dialog box, there are two buttons: 'Save' and 'Cancel'.

| Alarm / Fault Name | Latch | Dial Out | Event Log | Audible |
|---------------------|-------|----------|-----------|---------|
| FAULTS | | | | |
| CB1 SHUNT TRIP FAIL | NO | YES | NO | YES |
| CB2 SHUNT TRIP FAIL | NO | YES | YES | YES |
| CONTACTOR NEUT FAIL | NO | YES | YES | YES |
| CONTROL MODULE FAIL | NO | YES | YES | YES |
| EQUIPMENT FAN FAIL | NO | YES | YES | YES |

User Settings

The User Settings choice allows you to adjust the user-accessible switch settings. Access is limited to qualified personnel via system security.

To access the User Settings dialog box:

1. Select CONFIG.
2. Select USER SETTINGS from the pop-up menu.

The User Settings dialog box is displayed. See **Figure 67**. The top six buttons access a series of secondary dialog boxes to configure the various settings.

Figure 67 User settings dialog box

Source Setpoints

The Source 1/2 Setpoints allows you to configure trigger points for each input source (1 or 2) for the STS2/PDU via a keypad dialog or HI/LO dialog box. The source numbers do not designate the source as the preferred or alternate source. The numbers simply identify the input source. See **10.2 - Manual Transfer / Preferred Source Selection** to set the preferred source.

The Setpoints are based on values in relation to the nominal voltage required for the STS2/PDU. UV refers to under voltage, meaning the amount of voltage below the nominal voltage. OV refers to over voltage or the amount of voltage over the nominal voltage.

- Fast UV Setting (%) — if the voltage drops below this set percentage of the nominal voltage, the STS2/PDU transfers from the current source to the opposite source.
- Slow UV Setting (%) — if the voltage remains this set percentage below the nominal voltage for the period of the slow detection delay, the STS2/PDU transfers from the current source to the opposite source.
- Slow UV detection delay — the number of cycles that the source must remain below the Slow UV Setting before the STS2/PDU transfers.
- OV Setting (%) — if the voltage exceeds this set percentage of the nominal voltage for the period of the OV detection delay, the STS2/PDU transfers from the current source to the opposite source.
- OV Detection Delay — the number of cycles that the source must remain above the OV Setting before the STS2/PDU transfers sources.
- I-PK Xfer Lockout — if current from the source exceeds this threshold, the STS2/PDU disables source transfers and has to be reset either manually or automatically. The type of reset is configured under the User Settings.

To configure the setpoints for each source:

1. Select SOURCE 1/2 SETPOINTS from the User Settings dialog box. The Source 1/2 Setpoints dialog is displayed.

Figure 68 Source setpoints

2. Select 1 to configure the settings for Source 1.
3. Configure the settings using the keypad or dialog box that is displayed when you touch a button.

Table 17 Setpoint parameters

| Button | Range | Default | Comments |
|-------------------------|--|-------------------------------|--|
| Fast UV Setting (%) | -10 to -30% of Nominal voltage rating | -20% | Set in increments of 1%. |
| Slow UV Setting (%) | -5 to -20% | -10% | Set in increments of 1%. |
| Slow UV detection delay | 1-60 cycles | 5 cycles | Units: Line Cycle |
| OV Setting (%) | +5% to +20% | +10% | Set in increments of 1%. |
| OV Detection Delay | 1-255 cycles | 3 cycles | Units: 1/4 Line Cycle |
| I-PK Xfer Lockout | 0 – 3.0 multiplied by the unit current rating. | 2.5 Times Unit Current Rating | I-peak xfer lockout detection point. Units: Amps RMS. Select the HI or LO buttons to configure your setting. |

4. Select 2 for Source 2.
5. Configure the settings, as described in step 3.
6. Select SAVE to keep the settings for both sources. The Setpoints dialog is closed and the User Settings dialog is displayed.
7. Select MANUAL MAX XFER PHASE ANGLE. A keypad is displayed.

This setting configures the maximum allowed phase difference between the sources and applies to all manual transfers as well as any auto retransfer.

 - a. Configure this setting with a range of +/- 1-30 degrees. The default setting is +/-15 degrees and the resolution is 1 deg.
 - b. Select OK to save the setting. The setting is now displayed in the adjacent field in the User Settings dialog box.

8. Select **FREQUENCY TRIP POINT**. A keypad is displayed.
This choice verifies that the source is running at the proper frequency. This choice sets the frequency deviation in the frequency that triggers the frequency trip point alarm. The frequency deviation setting is the allowable frequency variation from nominal (60 or 50 Hz) before activating the frequency deviation alarm. The frequency setting applies to both input sources.
 - a. Configure this setting with a range of 0.1 – 3.0 Hz. The default setting is 0.5 and the resolution is 0.1.
 - b. Select **OK** to save the setting.
9. Select **RETRANSFER DELAY**. A keypad is displayed.
With the secondary source being used, this setting sets the length of time the switch waits until attempting to transfer back to the preferred source.
 - a. Configure this setting with a range of 1 to 60 seconds. The default setting is three (3) seconds and the resolution is 1 second.
 - b. Select **OK** to save the setting. The setting is now displayed in the adjacent field in the User Settings dialog box.
10. Select **AUDIO LEVEL**. A dialog box is displayed with **HI** and **LO** settings.
This choice sets the loudness of the horn or beeper that is sounded for audible alarms.
 - a. Configure this setting with a range of 1–10 (ten). The default setting is 5. The settings have an increment of 1 (one).
 - b. Select **OK** to save the setting. The setting is now displayed in the adjacent field in the User Settings dialog box.
You can select **TEST** to briefly sound the alarm to judge its volume.
11. Select **DISPLAY BRIGHTNESS**. A dialog box is displayed with **HI** and **LO** settings.
This choice sets the brightness for the touch screen.
 - a. Configure the Contrast and Brightness settings with a range of 1 – 10 (ten).
 - b. Select **OK** to save the settings.
12. Set the **AUTO REXFER ENABLE** choice. The auto retransfer enable setting determines whether the switch automatically returns the preferred source after that source is restored.
 - Select **YES** to enable the automatic transfer.
 - Select **NO** to disable the automatic transfer. The setting requires transfers be done manually.
13. Set the **AUTO RESTART ENABLE** choice. This setting determines whether the STS2/PDU can be started automatically when power is restored after it has been lost.
Select **YES** to enable the automatic restart.
Select **NO** to disable the automatic restart. This settings requires a manual restart of the STS2/PDU.
To manually restart the STS2/PDU:
 - a. Select **SOURCE TRANSFER** from the **MENU** bar. The **SELECT PREFERRED SOURCE** window is displayed.
 - b. Select **Source 1** or **Source 2** as your preferred source. The unit will restart.
14. Select a setting for the **I-PEAK RESET**.
Select **AUTO** to configure the Static Transfer Switch 2 Power Distribution Unit to automatically reset when a fault clears and the voltage and current are normal.
Select **MAN** to require a manual reset of the Static Transfer Switch 2 Power Distribution Unit when fault clears and the voltage and current are normal.



CAUTION

Risk of equipment damage and personnel injury.

Use of Auto Restart is site specific. Do not enable auto restart unless the infrastructure is designed for unattended operation and there is no chance of equipment or personnel harm by automatic re-energizing of the system.

Consult with your Liebert site Engineer as to whether Auto restart should be enabled.

PDU Setpoints

The PDU Setpoints option allows you to configure the following parameters for the PDU, shown in **Figure 69**.

- Load Voltage THD (%)
- Neutral Current (% of nom)
- Ground Current (A)
- Load Bus Overcurrent (% of nom)

Figure 69 PDU setpoints

Table 18 shows the range of valid values, default values and resolution for each parameter.

Table 18 PDU setpoints

| Button | Range | Default | Resolution |
|---------------------------------|---------------|---------|------------|
| Load Voltage THD (%) | 3.0% to 99.9% | 15.0% | 0.1 |
| Neutral Current (% of nom) | 10% to 200% | 95% | 1 |
| Ground Current (A) | 1.0A to 50.0A | 5.0A | 0.1 |
| Load Bus Overcurrent (% of nom) | 50% to 100% | 100% | — |

System Settings

The System Settings choice under the Config menu displays another pop-up menu with three choices:

- Comm Options
- System Options
- System ID

To access the System Settings menu:

1. Select CONFIG from the menu bar.
2. Select SYSTEM SETTINGS from the Config menu.

Comm Options

The Comm Options dialog box allows you to configure the communications settings for the STS2/PDU.

- Select COMM OPTIONS from the System Settings Menu.
- The Comm Options dialog box is displayed. See **Figure 70**.
- An option can be enabled by selecting YES.
- An option can be disabled by selecting NO.
- An option can be configured by selecting the adjacent option button to display a separate configuration dialog box.

The instructions for configuring the communications options are provided in this section.

Figure 70 Comm options dialog box

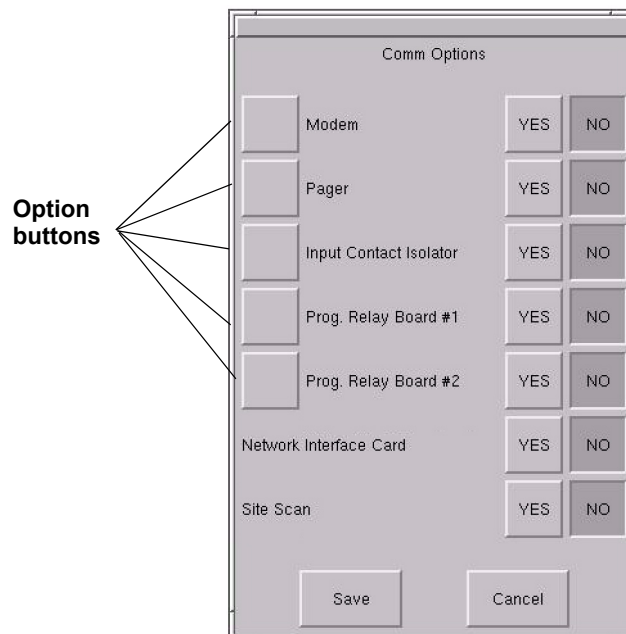

Configuring the Modem

The Modem dialog box allows you to configure the optional, internal modem or an external modem that is connected to the Static Transfer Switch 2 Power Distribution Unit. Only one modem can be utilized by the STS2/PDU.

The dialog box contains a series of choices that access either a keypad or a secondary dialog to configure settings. Auto dial can also be configured for the modem to be triggered by events, as set up in the Event Mask choices.

Designated major alarms activate the auto dial modem sequence. Automatic dial attempts are made to the first number three times, at 30 seconds between attempts. If connection is not established in that time period, the system automatically rolls over to the second number. Auto dial attempts are made again three more times at 30 seconds between attempts. The process is repeated until a successful connection is made. Upon successful connection, the system transmits a present status data, including all active alarms messages. After transmission, the modem automatically hangs up and returns to the auto-answer mode.

To configure the modem:

1. Select MODEM from the Comm Options menu. The Modem dialog box is displayed.

Figure 71 Modem dialog box

2. Select the type of modem that the STS2/PDU will be using:
 - Select INT if the STS2/PDU will be communicating via an internal modem.
 - Select EXT if the STS2/PDU will be communicating via an external modem.
3. Select the PRIMARY LINE choice to enter the primary telephone number for the modem to dial when an alarm is triggered.
4. Enter the number in the keypad dialog box.
5. Select OK to save the telephone number. The number is displayed in the field adjacent to the Primary Line choice.
6. Select the SECONDARY LINE choice to enter the secondary telephone number for the modem to dial when an alarm is triggered.
7. Enter the number in the keypad dialog box.
8. Select OK to save the telephone number. The number is displayed in the field adjacent to the Secondary Line choice.
9. Select INIT. STRING to configure the initialization string. This string configures the parameters of the modem.
 - This setting only needs to be configured if an external modem is used. Check your modem's documentation for this setting.
 - The string for the internal modem set by the manufacturer and does not need to be changed.
10. Select BAUD RATE to display a dialog with the baud rate choices:
 - For an external modem, select from 2400 bps, 9600 bps or 19200 bps.
 - An internal modem only supports 2400 bps.
11. Configure the MODEM HEALTH CHECK. The Health Check verifies that the modem is working properly. This setting allows you to enable the check and set when it is run.
 - a. Select the button to display the Modem Health Check dialog box, from which you can access further dialogs to set the time and days that the check is run.
 - b. Select SAVE to keep the settings.
The Health Check dialog box is closed and the Modem dialog box is again active.
 - c. Select YES in the Modem dialog box to activate the Modem Health Check. If you select NO, the Modem Health Check is not run.

12. Configure AUTO DIAL IN. Auto Dial In allows a user to dial into the STS2/PDU through the modem to check status and access the system via a hyperterminal connection.
 - a. Select YES to activate the dial in feature.
 - b. Select NO to deactivate the dial in feature.
13. Configure AUTO DIAL OUT. Auto Dial Out allows the STS2/PDU to automatically dial out to a system to notify a user of an event or status.
 - a. Select YES to activate the dial out feature.
 - b. Select NO to deactivate the dial out feature.
14. Select SAVE to keep the modem configuration settings.
15. Select YES in the Comm Options dialog box to activate the settings. You are returned to the Comm Options dialog box.

Configuring the Input Contact Isolator Settings

The Input Contact Isolator (ICI) is an optional, eight-channel input board for up to eight external user alarm or message inputs to be routed to the Static Transfer Switch 2 Power Distribution Unit's alarm network.

The contact is set to either be normally open or normally closed. When a contact closes or opens, an event is triggered. See **6.2 - Input Contact Isolator Board** for more information on the ICI.

The Input Contact Isolator options are configured through the Input Contact Isolator dialog box, which is accessed from the Comm Options dialog box. The Input Contact Isolator dialog box contains eight choices to match the eight channel input board. You can label each button to identify the event associated with the contact. When the dialog box is accessed, each button flashes to display the Input Contact Isolator number and the user entered label. This label also appears in the Display Panel when an event related to an Input Isolator Connector is triggered.

The Input Contact Isolator dialog box allows you to:

- Label the input contact assignments for your setup.
- Set the delay for an external event triggering an alarm.
- Review the isolator contact assignments, once the labels are entered.

The delay allows you to set the number of seconds which a condition needs to persist to trigger an alarm.

These input alarms can also be configured to activate a programmable relay output, which is discussed in **Configuring the Programmable Relay Board Settings on page 109**.

To configure the Input Contact Isolator relays:

1. Select INPUT CONTACT ISOLATOR from the Comm Options menu.
The Input Contact Isolator dialog box is displayed.

Figure 72 Input Contact Isolator dialog box

| INPUT CONTACT # | DELAY | Value |
|------------------|-------|-------|
| INPUT CONTACT #1 | DELAY | 0.0 |
| INPUT CONTACT #2 | DELAY | 0.0 |
| INPUT CONTACT #3 | DELAY | 0.0 |
| INPUT CONTACT #4 | DELAY | 0.0 |
| INPUT CONTACT #5 | DELAY | 0.0 |
| INPUT CONTACT #6 | DELAY | 0.0 |
| INPUT CONTACT #7 | DELAY | 0.0 |
| INPUT CONTACT #8 | DELAY | 0.0 |

Buttons: Save, Cancel

2. Select INPUT CONTACT 1.
A keyboard is displayed to allow you to enter the name of the alarm.
3. Enter the name of the alarm set for that input. For example, a fan problem could be indicated by naming the button FAN.
4. Select OK on the keyboard to keep your label.

5. Select DELAY.
A keypad is displayed prompting you for a delay time, in seconds, for a condition to exist before the alarm is triggered.
6. Enter the delay value. The range for the values are from 0 (zero) to 99.9 seconds.
7. Select OK on the keypad to keep your setting.
The value you entered is displayed in the field adjacent to the corresponding input contact.
8. Repeat **Steps 2 to 7** for each input contact.
9. Select SAVE after you have configured all input contacts.
Be sure to select Save even if you have accessed this dialog only to change a setting.
10. Enter the settings in **Table 32 - Input contact isolator settings record**.
This information is not saved if control power is removed.
11. Select OK in the Comm Options dialog box to activate the settings.

Configuring the Programmable Relay Board Settings

The STS2/PDU can contain up to two programmable relay boards (PRB) that can trigger an external device when an event occurs in the Static Transfer Switch 2 Power Distribution Unit. For example, if Source 1 fails, an external light flashes.

See **6.1 - Programmable Relay Board** for more information on the PRBs.

The programmable relay board dialog box with two options: STANDARD SET and USER DEFINED SET. The STANDARD SET are the factory-configured settings.

The STANDARD SET for the programmable relay board settings are:

Table 19 Standard settings for programmable relays

| Relay | Setting | Definition |
|-------|-------------------|---|
| 1 | SOURCE 1 FAIL | Source 1 failure |
| 2 | SOURCE 2 FAIL | Source 2 failure |
| 3 | BYPASS CB4 CLOSED | Switch (CB4) is closed; Source 1 is bypassed. |
| 4 | BYPASS CB5 CLOSED | Switch (CB5) is closed; Source 2 is bypassed. |
| 5 | TRANSFER INHIBIT | A transfer between Source 1 and Source 2 is being restrained. |
| 6 | OUT OF SYNC | The phase difference between sources 1 and 2 exceeds the allowable threshold for transfer. |
| 7 | EQUIP OVER TEMP | The ambient temperature of the ProductName exceeds the recommended threshold for operation. |
| 8 | Blank | No setting |

The USER DEFINED SET allows you to assign faults and alarms to each contact on the relay boards.

Utilizing the USER DEFINED SET, you can also select Input Contact Isolators to associate with a programmable relay.

In addition individual events, three other assignment choices are available:

- SELECT ALL sends a summary event to the selected relay whenever any event occurs. If this setting is selected for a relay, no other event needs to be assigned for that relay.
- ON SOURCE 1 or ON SOURCE 2 can be assigned to a relay to send a notification when that source is being used by the load.

Once configured, the Static Transfer Switch 2 Power Distribution Unit continuously checks the status of the items defined for each contact and updates the state of the relay.

To configure your programmable relay boards for user defined settings:

1. Select PROG. RELAY BOARD # x from the Comm Options dialog box, where x is the corresponding board number.
The Prog. Relay Board dialog box is displayed.

Figure 73 Programmable relay board dialog box

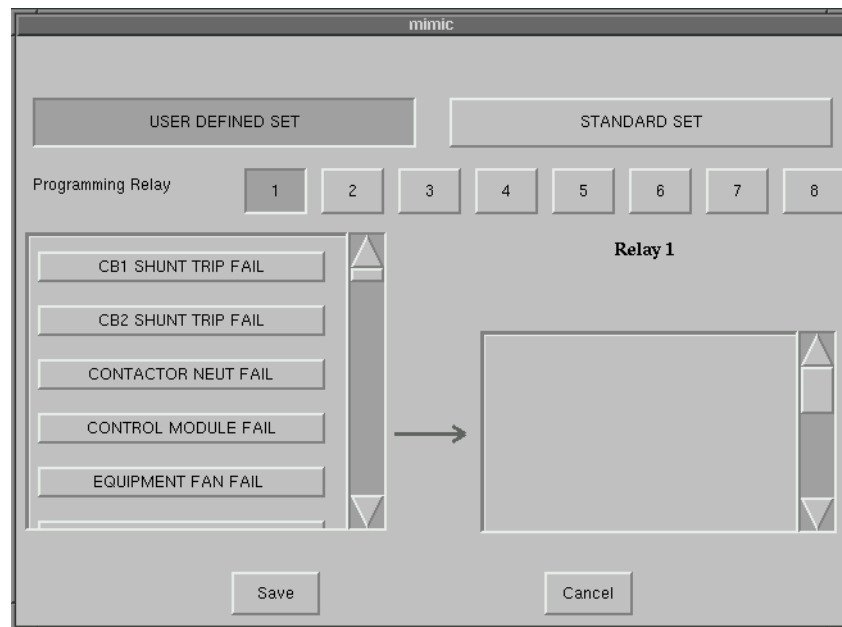

2. Select your configuration settings.
 - Select STANDARD SET to use the settings configured at the factory. See Go to step 4.
 - Select USER DEFINED SET to configure your own settings. Go to step 3.
If you enter a user defined settings, this information is not saved if control power is removed. Record the settings in **Table 31**.
3. To define your relay board settings:
 - a. Select a Programming Relay.
 - b. Select an event you want associated with the relay. That fault is placed in the Relay column. You can associate up to ten (10) events with one relay. If you do so, you should group the events logically to simplify troubleshooting when an event is triggered.
4. Select SAVE to keep the settings.
5. Select OK for the applicable Programmable Options Board option in the Comm Options dialog box to activate the settings.

Configuring the Network Interface Card

An optional Liebert OpenComms Network Interface Card (NIC) can be installed in the STS2/PDU to provide Ethernet connectivity via an RJ-45 port.

Ethernet cabling is the responsibility of the customer. Category 5 cabling is required.

See **6.5 - Network Interface Card (NIC)** for more information on the NIC.

See the OpenComms Network Interface Card Installation and Users Guide for configuration instructions for the card.

If the optional OpenComms NIC is installed in the STS2/PDU:

- Select YES for the Network Interface Card option in the Comm Options dialog box to activate the card.

SiteScan Configuration

An RS-422 port on the optional Comms Board provides communications with Liebert's SiteScan. SiteScan is Liebert's system monitoring software that allows you to utilize a PC to monitor the Static Transfer Switch 2 Power Distribution Unit's status and check alarms. See **6.3 - Comms Board** for more information on this board.

If the STS2/PDU will be connected to SiteScan:

- Select YES for the SiteScan choice in the Comm Options dialog box to activate the card.

Saving Your Communications Configurations

To save you communications configuration settings:

1. When you have completed the Comm Options configurations, ensure you have selected YES for all the settings that you want activated.
2. Select SAVE to keep the settings.
Whenever you make modifications to the any of the Comm Options, select SAVE to keep the changes.

System Options

Most System Options are configured at the factory. However, you may need to set two of the choices after the unit is installed: Wye Output Transformer and Remote Source Selection.

- Select SYSTEM OPTIONS from the System Settings Menu.
The System Options dialog box is displayed.
- An option is enabled by selecting YES.
- An option is disabled by selecting NO.

Figure 74 System options

| Option | YES | NO |
|------------------------------|-----|----|
| Dual Output Breaker | YES | NO |
| <input type="checkbox"/> PDU | YES | NO |
| 4 Pole Transfer Switch | YES | NO |
| Shunt Trip | YES | NO |
| Wye Output Transformer | YES | NO |
| Remote Source Select | YES | NO |

Save Cancel

Dual Output Breaker

This selection is set at the factory. The choice is set to YES to enable both output breakers (CB3 and CB3A) when two are installed in the unit. If only one output breaker (CB3) is installed, the setting is set to NO.

PDU

This selection is set at the factory to YES, which allows the LCD to draw the Mimic accordingly and display PDU metering and alarm information.

Select the PDU button in the System Options window (see **Figure 74**). This opens the PDU Options window, shown below in **Figure 75**.

Figure 75 PDU options button

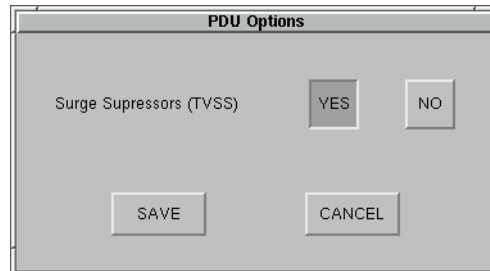

The PDU Options window allows you to specify whether you have the surge suppression option.

- If the TVSS option is installed, this selection is set at the factory to YES. To disable surge suppression, click NO.
- Click SAVE.

4 Pole Transfer Switch

This selection is set at the factory to indicate whether the system is a 3 pole or 4 pole unit. The 4 pole design is not available at this time.

Shunt Trip

This selection is set at the factory.

Wye Output Transformer

The Wye Output Transformer controls the firing of the SCRs on startup, which minimizes the inrush into PDU transformers. Output breakers and PDU input breakers have to be closed when you start up the system. Based on whether the input side of the PDU transformer is configured as a Wye or Delta changes the firing sequence of the SCRs.

If the STS2/PDU is connected to a PDU configured as a Wye:

- Select YES for the Wye Output Transformer choice in the System Options dialog box.

Remote Source Select

If your system is configured with the optional Remote Source Selection, it must be enabled from the System Options menu. See **4.4 - Remote Source Selection Wiring** for more information.

If the system is utilizing Remote Source Selection:

- Select YES for the Remote Source Select choice in the System Options dialog box to activate the option.

System ID

Most of the settings for System ID are set by Liebert either at the factory or when the unit is installed.

The system is identified and tracked with these numbers: Order No., System Tag No., System ID No. and Model No.

Language, Time and Date are synchronized with the location of the unit.

The only configurable field is the Password. See **Using the Password on page 98** for more information on configuring and using the password.

13.7.1 Logs

Two types of logs are kept by the STS2/PDU: Event Log and History Log.

Event Log

The Event Log tracks the alarms and faults of the STS2/PDU.

See **11.0 - Alarms and Faults** for more information on these events and see **11.2.1 - Event Log** for more information on the Event Log and definitions of the fields displayed in the Event Log screen.

Figure 76 Event log

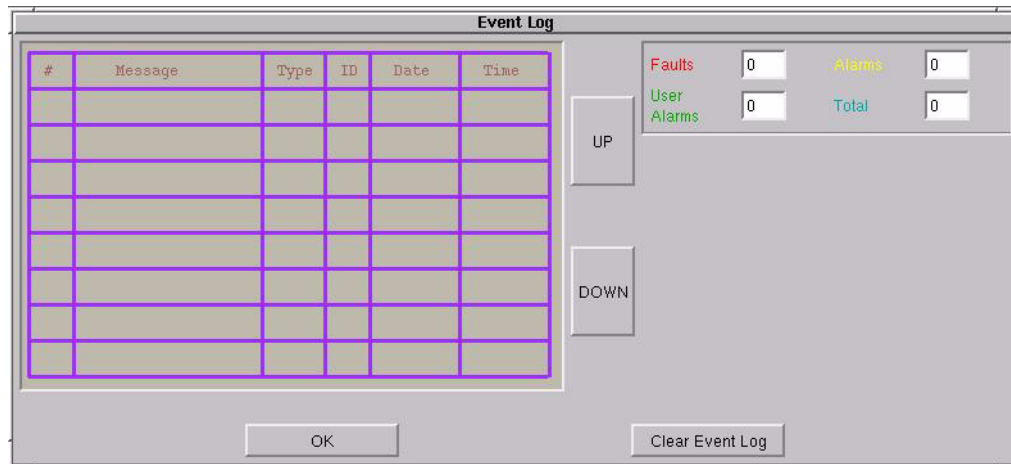

To use the Event Log:

1. Select LOGS from the menu bar to open the Logs menu.
2. Select EVENT LOG from the menu.
3. Use the UP and DOWN buttons to scroll through the event list.
4. Select OK to close the Event Log. The data remains in the log.

History Log

Two History Logs are available to track major alarms. If so configured, an alarm freezes the history buffer. When the History Status buffer is frozen, a History Log is created that can be accessed from the HISTORY LOG x choices in the LOGS menu.

See **11.2.2 - History Log** for more information on the History Logs and definitions of the fields displayed in the History Log screen.

Figure 77 History log

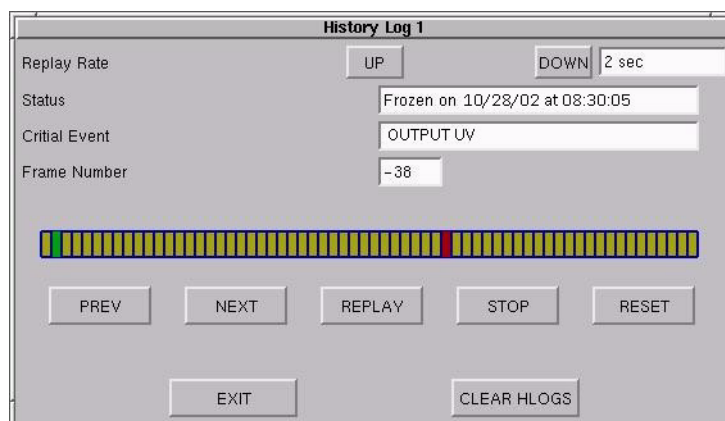

To use the History Log:

1. Select LOGS from the menu bar to open the Logs menu.
2. Select either HISTORY LOG 1 or HISTORY LOG 2 from the menu.
3. Select the appropriate buttons to replay the log:
 - Select PREV to go to the previous frame in the sequence.
 - Select NEXT to go to the next frame in the sequence.
 - Move the green cursor to the location from which you would like to play the sequence of events.
 - Select REPLAY to play the frames automatically from the point of the cursor.
 - Select STOP to halt the replay.
 - Select RESET to return to the first frame in the log.
4. Select EXIT to close the History Log. The data remains in the log.
 - Use CLEAR HLOGS to remove the data from both history logs.

**NOTE**

Event and History Logs are protected by security. The password or a disabled key lockout is required on such equipped units to clear these logs.

13.7.2 Source Transfers

The Source Transfer choice (SOURCE XFERS) allows you to manually select a preferred source.

To switch the primary source, refer to **10.2 - Manual Transfer / Preferred Source Selection**.

13.7.3 Startup Procedure

You can access instructions for starting the STS2/PDU from the menu bar.

- From the menu bar, select STARTUP PROC.

These instructions are also provided on **10.1 - Normal System Turn-On**.

13.7.4 Bypass Procedure

You can access instructions for bypassing the Static Transfer Switch 2 Power Distribution Unit from the menu bar.

- From the menu bar, select BYP. PROC.

The instructions are provided in the display panel.

Bypass procedures are also discussed in **10.4 - Maintenance Bypass**.

13.7.5 Help

You can select an event in the Event Display to display more information about that event in the Display Panel. This same help is also available in **15.0 - Event Message Help Text**.

13.7.6 Logo

The Logo menu choice shows the Liebert and Emerson logo in the Display panel.

13.8 Cleaning the LCD Touch Screen

If the touch screen requires cleaning, use a pre-moistened towelette designed for cleaning CRTs or dampen a soft, non-abrasive cloth with a very mild cleaning solution.

Do not spray the cleaner directly onto the touch screen, as drips may run down into the screen and damage the equipment.

Close all menus and dialog boxes before cleaning the touch screen.

14.0 SPECIFICATIONS

14.1 System Configuration

The STS2/PDU can be set in several different configurations, according to the model and location. The configuration is set at the factory and does not need to be changed by the customer.

14.1.1 Frequency

The STS2/PDU accepts input frequencies of 50 Hz or 60 Hz, depending on the model ordered. The frequency shall be within +/- 0.5 Hz of the nominal frequency.

14.1.2 Input Voltage

The STS2/PDU models are available to handle various voltages.

The input voltage must be three phase AC (3 wire-plus-ground).

The voltage shall be within +/- 10% of the nominal voltage.

The following table provides nominal voltages, listed according to frequency.

Table 20 Input voltage

| 60 Hz (L-L) | 50 Hz (L-L) |
|----------------|----------------|
| 208V | 208V |
| 380V | 380V |
| 400V | 400V |
| 415V | 415V |
| 480V | - |
| 600V | - |

14.1.3 Output Voltage

The output voltage shall be three phase AC (4 wire-plus-ground).

Table 21 Output voltage

| 60 Hz (L-L/L-N) | 50 Hz (L-L/L-N) |
|--------------------|--------------------|
| 208/120V | 208/120V |
| 380/220V | 380/220V |
| 400/230V | 400/230V |
| 415/240V | 415/240V |

14.1.4 System Current Ratings

These ratings are based upon continuous switch current rating. All units are 100% continuous current rated. Some ratings are not available in certain voltages.

Table 22 System current ratings

| Current |
|---------|
| 250A |
| 400A |
| 600A |
| 800A |

14.1.5 Grounding

Refer to 4.2 - **System Grounding** for specifications and instructions regarding grounding.

14.1.6 Electrical Requirements

Table 23 Electrical requirements

| Item | Requirement |
|----------------------------|---|
| Maximum Continuous Current | 250, 400, 600, 800 amps |
| Load Power Factor Range | 0.75 to 1.0, leading or lagging |
| Load Crest Factor | Up to 3.5 |
| Source Voltage Distortion | Up to 10% THD with notches and ringing transients |
| Overload Capability | 125% for 30 minutes 250A-400A |
| | 125% for 10 minutes 600A-800A |
| | 150% for 2 minutes |
| | 500% for 0.25 sec |

Table 24 Unit short circuit withstand capability

| Unit Voltage | Unit Amps | Withstand Capability |
|--------------|-----------|----------------------|
| 208-240V | 250A | 100kA |
| | 400-600A | 100kA |
| | 800A | 100kA |
| 380-480V | 250A | 65kA |
| | 400-600A | 100kA |
| | 800A | 65kA |
| 600V | 250A | 25kA |
| | 400-600A | 25kA |
| | 800A | 42kA |

14.1.7 Surge Suppression

The static transfer switch is equipped with transient voltage surge suppression on each input for surge suppression. The surge suppression is capable of protecting the static transfer switch from operating outside of tolerances due to surges as defined by IEC 1000-4-5 (1.2/50uS surge, 2kV CM and 1kV DM) as required under EN 50091-2. Optional surge suppression modules (TVSS) are available for each input of the STS2/PDU for surge protection of the transformers.

14.1.8 Response Time

A dual level fast/slow transfer threshold is used for under voltage detection to allow the STS2/PDU to be compatible with UPSs and generators. The voltage thresholds and the slow transfer delay time is user-adjustable. The fast transfer delay time is less than 4 ms.

The over voltage detection uses a single threshold, with programmable level and delay time. See **User Settings on page 101** for instructions on configuring these settings.

14.1.9 Environmental Requirements

See **3.0 - Locating The STS2/PDU** for details concerning environmental requirements for the STS2/PDU.

14.2 System Components

All STS2/PDU models provide two isolation transformers connected to a solid-state, three-pole dual-position static transfer switch within one enclosure, with the ability to transfer between two input sources to a single output.

All STS2/PDUs are configured with an LCD Color Graphical Interface touch screen display for monitoring and configuring the unit.

14.2.1 Frame and Enclosure

The complete STS2/PDU is housed in a freestanding enclosure. The cabinet is a NEMA type 1 enclosure. The cabinet is structurally designed to handle lifting from the base. The frame is designed to accommodate floor stands.

Table 25 Frame sizes

| Rating | Width x Depth x Height in. (mm) |
|------------|------------------------------------|
| 250A | 60 x 32 x 77 (152 x 81 x 196)* |
| 400 – 600A | 73 x 49 x 77 (186 x 125 x 196) |
| 800A | 96 x 49 x 77 (244 x 125 x 196) |

* Width is 76.8 in (195 cm) with output distribution cabinet

The distributed floor weight for STS2/PDU is less than 260 lbs./sq. ft. (118 kg/m²).

The required service access is front and one side of the unit, 250A without output cabinet is front access only. Side access depends on which side the output cabinet is mounted, can be left or right.

The STS2/PDU can be tipped 15° in any direction without falling over.

14.2.2 Caster and Leveling - 250A only

The 250A unit frame includes heavy-duty swivel casters for ease of installation, plus permanent leveling feet for final installation.

14.2.3 Cooling

The STS2/PDU 250A units utilize convection air cooling for the enclosure with forced air cooling of the heat sinks.

The 400-800A units are fan cooled using low-velocity fans to minimize audible noise. All fans are redundant so that a single fan failure cannot cause temperatures to increase beyond acceptable limits.

Air intake is through screened protective openings in the front of the unit. A standard furnace filter is installed behind the openings.

By opening the front door, the filter can be changed easily without exposing personnel to high voltage. The size of the filter is 1 in. x 25 in. x 25 in. (2.54 cm x 63.5 cm x 63.5 cm).

The air exhaust is through the top of the unit.

14.2.4 Access

The STS2/PDU is designed so repairs and maintenance can be done from the front, side or top of the unit. All components that may need repair or replacement during routine field maintenance are safely accessed with the units in bypass without removing power from the unit. These components include:

- All electronic PCB assemblies
- Power supply assemblies
- All control fuses
- All circuit breaker plug-in modules
- Fans
- SCRs

All power connections are designed to maintain proper connection torque over the lifetime of the unit without any maintenance. The integrity of the connections can be checked via infrared scanning safely from the front or top of the unit.

All other components including transformers, power cables and connections, circuit breaker bases, etc., are replaceable from the front, rear or top of the unit, but this requires all power to be removed from the unit for safety. Although routine re-torquing of the power connections is not required, if maintenance of these connections is needed, complete removal of power is required from the unit for safety reasons.



WARNING

Lethal voltages exist inside the unit during normal operation. Only qualified service personnel should perform maintenance on the Static Transfer Switch 2 Power Distribution Unit.

The unit is supplied by more than one power source. The unit contains hazardous voltages if any of the input sources is on, even when the unit is in bypass. To isolate the unit, turn off and lock out all input power sources.

Verify that all input power sources are de-energized and locked out before making connections inside unit.

14.2.5 Circuit Breakers

The STS2/PDU is equipped with two input plug-in circuit breakers and five or six (if CB3A is used) molded-case, plug-in, non-automatic circuit breakers. The breakers are UL listed for use up to 600VAC and CE marked. The plug-in feature of the breaker includes an interlock, which prevents the breaker from being unplugged without being in the OFF (open) position.

Mechanical interlocks are provided on the breakers to prevent improper maintenance bypassing of the solid-state switch. A bypass breaker cannot be closed unless the solid-state switch is connected to the same input source and only one bypass breaker can be closed at a time. All breakers are equipped with N.O. and N.C. auxiliary switches for monitoring of the breaker positions. The two solid-state static switch input breakers are equipped with 48 VDC shunt trips to allow for control by the STS2/PDU logic. See **Tables 9 through 11**.

14.2.6 Cable Entrance

Removable conduit termination plates are provided in the top and bottom of the STS2/PDU for termination of the two source input conduits or raceways and/or the output conduits or raceways. On units with inline panelboards, output conduit or raceways are bottom exit only.

14.2.7 Doors

A removable key lock hinged front door provides access to the circuit breakers.

14.2.8 Color Graphical Display

The display is located in the front of the unit. Front panel display is an LCD touch screen display for monitoring and configuring the unit. See **Figure 57** for a drawing of the touch screen display.

14.2.9 RS-232 Port

The unit is equipped with an RS-232 port for connecting a terminal or PC. See **Figure 55** for the port's location. See **12.1 - Using the RS-232 Port** for instructions on using a PC terminal with the unit.

14.2.10 Terminal Port Connections

The system has an asynchronous serial port configured as Data Terminal Equipment for terminal access only (half duplex). The CPU services the terminal port with no handshaking. The serial port conforms to RS-232 levels with a data format of 9600 Baud, 1 start bit, 8 data bits and no parity bits. The serial port is 1000VDC isolated (non-SELV) and ESD protected to 15kV air discharge.

The connector is a 6 Pin MTA plug with connections shown below.

Table 26 MTA plug pinout

| Pin | Signal Name | Function / Comments |
|-----|-------------|---|
| 1 | ISO_GND | Isolated service terminal ground |
| 2 | ISO_TXD | Isolated service terminal transmit output |
| 3 | ISO_RXD | Isolated service terminal receive input |
| 4 | NC | No Connection |
| 5 | NC | No Connection |
| 6 | NC | No Connection |

A DB9 male connector is added and connected parallel to the 6 position header. It is configured as DTE.

Table 27 DB9 pinout

| Pin | Signal Name | Function / Comments |
|-----|-------------|---|
| 1 | NC | No Connection |
| 2 | ISO_RXD | Isolated service terminal transmit output |
| 3 | ISO_TXD | Isolated service terminal receive input |
| 4 | NC | No Connection |
| 5 | ISO_GND | Isolated service terminal ground |
| 6 | NC | No Connection |
| 7 | NC | No Connection |
| 8 | NC | No Connection |
| 9 | NC | No Connection |

14.2.11 RS-232 Interface Parameters

The service terminal interface parameters are the following settings and cannot be changed.

Table 28 RS-232 settings

| Parameter | Setting |
|-----------------------|---------------------------------|
| Interface | RS-232 Using EIA Voltage Levels |
| Baud Rate | 9600 |
| Parity | None |
| Number of Data Bits | 8 |
| Number of Stop Bits | 1 |
| Hardware Flow Control | Off |
| Terminator | <CR> <LF> |
| Handshaking | Not supported |
| Structure | Full duplex |
| Local Echo | Off |

14.2.12 Maintenance Bypass

The STS2/PDU is configured to allow the unit's electronics to be bypassed to either input source for maintenance without interruption of power to the load.

The STS2/PDU is furnished with key-interlocked maintenance bypass breakers to configure the bypass.

STS2/PDU units have all electronics isolated from the input, output and bypass connections to allow safe servicing of any components without access to hazardous voltages when the unit is in maintenance bypass.

See **10.4 - Maintenance Bypass** for instructions.

14.2.13 Fuseless Design

All STS2/PDU units are fuseless.

14.2.14 Options

The following options are available for the STS2/PDU:

- Panelboards
- Subfeed Breakers
- K-Factor Transformers
- Surge Suppression System (TVSS)
- Redundant Static Switch Output Breaker
- Programmable Relay Board
- Comms Board w/SiteScan and Modem Interface
- Internal Modem
- Input Contact Isolator Board
- Network Interface Card (NIC)
- Remote Source Selection
- Key Lockout Switch
- Export Crating

See **6.0 - Options** for more information.

15.0 EVENT MESSAGE HELP TEXT

Key

ALL CAPS = Event message displayed in the Event Display panel in the lower left corner of the LCD.

Indented text = Help text shown in the Display Panel in the lower right corner of LCD.

BOLD = Commands that are sent through the RS-232 port.

S1 SCR SHORT

Source 1 SCR Short

One or more of the SCRs for Source 1 has shorted. Transferring between sources has been inhibited.

Contact technical support; in the United States, call 1-800-LIEBERT (1-800-543-2378). Outside the 48 contiguous United States contact Liebert Global Services, if available in your area. For international areas not covered by Liebert Global Services, the Liebert authorized distributor can provide technical support.

Press SILENCE on the touch screen to turn off the audible alarm, if so configured. If you are accessing the STS2/PDU system from a terminal, type **SH** and press RETURN on your keyboard to turn off the audible alarm.

This event and the system status surrounding it have been written to a History Log if the History Logs were not already full. This event was also written to the Event Log, if so configured.

The alarm has triggered a message to be sent to the modem, if so configured.

S2 SCR SHORT

Source 2 SCR Short.

One or more of the SCRs for Source 2 has shorted. Transferring between sources has been inhibited.

Press SILENCE on the touch screen to turn off the audible alarm, if so configured. If you are accessing the STS2/PDU system from a terminal, type **SH** and press RETURN on your keyboard to turn off the audible alarm.

This event and the system status surrounding it have been written to a History Log if the History Logs were not already full. This event was also written to the Event Log, if so configured.

The alarm has triggered a message to be sent to the modem, if so configured.

S1 SCR OPEN

Source 1 SCR Open.

One or more SCRs on Source 1 is open. Transferring between sources has been inhibited.

Contact technical support; in the United States, call 1-800-LIEBERT (1-800-543-2378). Outside the 48 contiguous United States contact Liebert Global Services, if available in your area. For international areas not covered by Liebert Global Services, the Liebert authorized distributor can provide technical support.

STS2/PDU output has been transferred to Source 2.

Press SILENCE on the touch screen to turn off the audible alarm, if so configured. If you are accessing the STS2/PDU system from a terminal, type **SH** and press RETURN on your keyboard to turn off the audible alarm.

This event and the system status surrounding it have been written to a History Log if the History Logs were not already full. This event was also written to the Event Log, if so configured.

The alarm has triggered a message to be sent to the modem, if so configured.

S2 SCR OPEN

Source 2 SCR Open.

One or more SCRs on Source 2 is open. Transferring between sources has been inhibited.

STS2/PDU output has been transferred to Source 1.

Contact technical support; in the United States, call 1-800-LIEBERT (1-800-543-2378). Outside the 48 contiguous United States contact Liebert Global Services, if available in your area. For international areas not covered by Liebert Global Services, the Liebert authorized distributor can provide technical support.

Press SILENCE on the touch screen to turn off the audible alarm, if so configured. If you are accessing the STS2/PDU system from a terminal, type **SH** and press RETURN on your keyboard to turn off the audible alarm.

This event and the system status surrounding it have been written to a History Log if the History Logs were not already full. This event was also written to the Event Log, if so configured.

The alarm has triggered a message to be sent to the modem, if so configured.

PRIMARY FAN FAIL

Primary Fan Failure

One of the primary cooling fans for the STS2/PDU has failed. The alternate fans are now running. The alternate fans are not monitored.

Contact technical support; in the United States, call 1-800-LIEBERT (1-800-543-2378). Outside the 48 contiguous United States contact Liebert Global Services, if available in your area. For international areas not covered by Liebert Global Services, the Liebert authorized distributor can provide technical support.

Press SILENCE on the touch screen to turn off the audible alarm, if so configured. If you are accessing the STS2/PDU system from a terminal, type **SH** and press RETURN on your keyboard to turn off the audible alarm.

This event was written to the Event Log, if so configured.

The alarm has triggered a message to be sent to the modem, if so configured.

CONTROL MODULE FAIL

Control logic module has failed.

One of the control modules on the control board has failed.

Contact technical support; in the United States, call 1-800-LIEBERT (1-800-543-2378). Outside the 48 contiguous United States contact Liebert Global Services, if available in your area. For international areas not covered by Liebert Global Services, the Liebert authorized distributor can provide technical support.

Press SILENCE on the touch screen to turn off the audible alarm, if so configured. If you are accessing the STS2/PDU system from a terminal, type **SH** and press RETURN on your keyboard to turn off the audible alarm.

This event was written to the Event Log, if so configured.

The alarm has triggered a message to be sent to the modem, if so configured.

If configured to be a latching alarm, press RESET on the display. If you are accessing the unit from a terminal, type **CA** and press RETURN on your keyboard.

PWR SPLY DC A FAIL

Power Supply DC Bus A Failed

The primary power supply is no longer providing DC power to the control board and the touch screen.

Contact technical support; in the United States, call 1-800-LIEBERT (1-800-543-2378). Outside the 48 contiguous United States contact Liebert Global Services, if available in your area. For international areas not covered by Liebert Global Services, the Liebert authorized distributor can provide technical support.

Press SILENCE on the touch screen to turn off the audible alarm, if so configured. If you are accessing the STS2/PDU system from a terminal, type **SH** and press RETURN on your keyboard to turn off the audible alarm.

This event was written to the Event Log, if so configured.

The alarm has triggered a message to be sent to the modem, if so configured.

If configured to be a latching alarm, press RESET on the display. If you are accessing the unit from a terminal, type **CA** and press RETURN on your keyboard.

PWR SPLY DC B FAIL

Power Supply DC Bus B Failed

The secondary power supply is no longer providing DC power to the control board and CAN options.

Contact technical support; in the United States, call 1-800-LIEBERT (1-800-543-2378). Outside the 48 contiguous United States contact Liebert Global Services, if available in your area. For international areas not covered by Liebert Global Services, the Liebert authorized distributor can provide technical support.

Press SILENCE on the touch screen to turn off the audible alarm, if so configured. If you are accessing the STS2/PDU system from a terminal, type **SH** and press RETURN on your keyboard to turn off the audible alarm.

This event was written to the Event Log, if so configured.

The alarm has triggered a message to be sent to the modem, if so configured.

If configured to be a latching alarm, press RESET on the display. If you are accessing the unit from a terminal, type **CA** and press RETURN on your keyboard.

PWR SPLY S1 AC FAIL

Power Supply Source 1 AC Failed

The AC input power to the power supplies from Source 1 has failed. The power supplies are now operating on AC power from Source 2. The AC input from Source 1 is still good.

Contact technical support; in the United States, call 1-800-LIEBERT (1-800-543-2378). Outside the 48 contiguous United States contact Liebert Global Services, if available in your area. For international areas not covered by Liebert Global Services, the Liebert authorized distributor can provide technical support.

Press SILENCE on the touch screen to turn off the audible alarm, if so configured. If you are accessing the STS2/PDU system from a terminal, type **SH** and press RETURN on your keyboard to turn off the audible alarm.

This event was written to the Event Log, if so configured.

The alarm has triggered a message to be sent to the modem, if so configured.

If configured to be a latching alarm, press RESET on the display. If you are accessing the unit from a terminal, type **CA** and press RETURN on your keyboard.

PWR SPLY S2 AC FAIL

Power Supply Source 2 AC Failed

The AC input power to the power supplies from Source 2 has failed.

The power supplies are now operating on AC power from Source 1. The AC input from Source 2 is still good.

Contact technical support; in the United States, call 1-800-LIEBERT (1-800-543-2378). Outside the 48 contiguous United States contact Liebert Global Services, if available in your area. For international areas not covered by Liebert Global Services, the Liebert authorized distributor can provide technical support.

Press SILENCE on the touch screen to turn off the audible alarm, if so configured. If you are accessing the STS2/PDU system from a terminal, type **SH** and press RETURN on your keyboard to turn off the audible alarm.

This event was written to the Event Log, if so configured.

The alarm has triggered a message to be sent to the modem, if so configured.

If configured to be a latching alarm, press RESET on the display. If you are accessing the unit from a terminal, type **CA** and press RETURN on your keyboard.

PWR SPLY LOGIC FAIL

Power Supply Module Failed

The power supply logic module contained in the primary power supply has failed.

Contact technical support; in the United States, call 1-800-LIEBERT (1-800-543-2378). Outside the 48 contiguous United States contact Liebert Global Services, if available in your area. For international areas not covered by Liebert Global Services, the Liebert authorized distributor can provide technical support.

Press SILENCE on the touch screen to turn off the audible alarm, if so configured. If you are accessing the STS2/PDU system from a terminal, type **SH** and press RETURN on your keyboard to turn off the audible alarm.

This event was written to the Event Log, is so configured.

The alarm has triggered a message to be sent to the modem, if so configured.

If configured to be a latching alarm, press RESET on the display. If you are accessing the unit from a terminal, type **CA** and press RETURN on your keyboard.

OUT VOLT SENSE FAIL

Output Voltage Sense Module Failed

The module contained on the snubber monitoring the output voltage has failed.

Press SILENCE on the touch screen to turn off the audible alarm, if so configured. If you are accessing the STS2/PDU system from a terminal, type **SH** and press RETURN on your keyboard to turn off the audible alarm.

Contact technical support; in the United States, call 1-800-LIEBERT (1-800-543-2378). Outside the 48 contiguous United States contact Liebert Global Services, if available in your area. For international areas not covered by Liebert Global Services, the Liebert authorized distributor can provide technical support.

This event was written to the Event Log, if so configured.

The alarm has triggered a message to be sent to the modem, if so configured.

If configured to be a latching alarm, press RESET on the display. If you are accessing the unit from a terminal, type **CA** and press RETURN on your keyboard.

S1 VOLT SENSE FAIL

Source 1 Voltage Sense Module Failed

The module contained on the snubber monitoring the input voltage from Source 1 has failed.

Press SILENCE on the touch screen to turn off the audible alarm, if so configured. If you are accessing the STS2/PDU system from a terminal, type **SH** and press RETURN on your keyboard to turn off the audible alarm.

Contact technical support; in the United States, call 1-800-LIEBERT (1-800-543-2378). Outside the 48 contiguous United States contact Liebert Global Services, if available in your area. For international areas not covered by Liebert Global Services, the Liebert authorized distributor can provide technical support.

This event was written to the Event Log, if so configured.

The alarm has triggered a message to be sent to the modem, if so configured.

If configured to be a latching alarm, press RESET on the display. If you are accessing the unit from a terminal, type **CA** and press RETURN on your keyboard.

S2 VOLT SENSE FAIL

Source 2 Voltage Sense Module Failed

The module contained on the snubber monitoring the input voltage from Source 2 has failed.

Press SILENCE on the touch screen to turn off the audible alarm, if so configured. If you are accessing the STS2/PDU system from a terminal, type **SH** and press RETURN on your keyboard to turn off the audible alarm.

Contact technical support; in the United States, call 1-800-LIEBERT (1-800-543-2378). Outside the 48 contiguous United States contact Liebert Global Services, if available in your area. For international areas not covered by Liebert Global Services, the Liebert authorized distributor can provide technical support.

This event was written to the Event Log, if so configured.

The alarm has triggered a message to be sent to the modem, if so configured.

If configured to be a latching alarm, press RESET on the display. If you are accessing the STS2/PDU system from a terminal, type **CA** and press RETURN on your keyboard.

S1 SCR SENSE FAIL

Source 1 SCR Sense Module Failed

The module contained on the snubber monitoring the SCRs for Source 1 has failed.

Press SILENCE on the touch screen to turn off the audible alarm, if so configured. If you are accessing the STS2/PDU system from a terminal, type **SH** and press RETURN on your keyboard to turn off the audible alarm.

Contact technical support; in the United States, call 1-800-LIEBERT (1-800-543-2378). Outside the 48 contiguous United States contact Liebert Global Services, if available in your area. For international areas not covered by Liebert Global Services, the Liebert authorized distributor can provide technical support.

This event was written to the Event Log, if so configured.

The alarm has triggered a message to be sent to the modem, if so configured.

If configured to be a latching alarm, press RESET on the display. If you are accessing the STS2/PDU system from a terminal, type **CA** and press RETURN on your keyboard.

S2 SCR SENSE FAIL

Source 2 SCR Sense Module Failed

The module contained on the snubber monitoring the SCRs for Source 2 has failed.

Press SILENCE on the touch screen to turn off the audible alarm, if so configured. If you are accessing the STS2/PDU system from a terminal, type **SH** and press RETURN on your keyboard to turn off the audible alarm.

Contact technical support; in the United States, call 1-800-LIEBERT (1-800-543-2378). Outside the 48 contiguous United States contact Liebert Global Services, if available in your area. For international areas not covered by Liebert Global Services, the Liebert authorized distributor can provide technical support.

This event was written to the Event Log, if so configured.

The alarm has triggered a message to be sent to the modem, if so configured.

If configured to be a latching alarm, press RESET on the display. If you are accessing the STS2/PDU system from a terminal, type **CA** and press RETURN on your keyboard.

S1 CURR SENSE FAIL

Source 1 Current Sense Failure

The module monitoring the current from Source 1 has failed. This module is contained on the left side gate driver board.

Press SILENCE on the touch screen to turn off the audible alarm, if so configured. If you are accessing the STS2/PDU system from a terminal, type **SH** and press RETURN on your keyboard to turn off the audible alarm.

This event was written to the Events Log, if so configured.

The alarm has triggered a message to be sent to the modem, if so configured.

If configured to be a latching alarm, press RESET on the display. If you are accessing the STS2/PDU system from a terminal, type **CA** and press RETURN on your keyboard.

S2 CURR SENSE FAIL

Source 2 Current Sense Failure

The module monitoring the current from Source 2 has failed. This module is contained on the right side gate driver board.

Press SILENCE on the touch screen to turn off the audible alarm, if so configured. If you are accessing the STS2/PDU system from a terminal, type **SH** and press RETURN on your keyboard to turn off the audible alarm.

This event was written to the Events Log, if so configured.

The alarm has triggered a message to be sent to the modem, if so configured.

If configured to be a latching alarm, press RESET on the display. If you are accessing the STS2/PDU system from a terminal, type **CA** and press RETURN on your keyboard.

S1 GATE DRIVE FAIL

Source 1 Gate Drive Failure

The gate drive module for an SCR for Source 1 has failed. This module is contained on the right side gate driver board.

Press SILENCE on the touch screen to turn off the audible alarm, if so configured. If you are accessing the STS2/PDU system from a terminal, type **SH** and press RETURN on your keyboard to turn off the audible alarm.

Contact technical support; in the United States, call 1-800-LIEBERT (1-800-543-2378). Outside the 48 contiguous United States contact Liebert Global Services, if available in your area. For international areas not covered by Liebert Global Services, the Liebert authorized distributor can provide technical support.

This event was written to the Event Log, if so configured.

The alarm has triggered a message to be sent to the modem, if so configured.

If configured to be a latching alarm, press RESET on the display. If you are accessing the STS2/PDU system from a terminal, type **CA** and press RETURN on your keyboard.

S2 GATE DRIVE FAIL

Source 1 Gate Drive Failure

The gate drive module for an SCR for Source 2 has failed. This module is contained on the left side gate driver board.

Press SILENCE on the touch screen to turn off the audible alarm, if so configured. If you are accessing the STS2/PDU system from a terminal, type **SH** and press RETURN on your keyboard to turn off the audible alarm.

Contact technical support; in the United States, call 1-800-LIEBERT (1-800-543-2378). Outside the 48 contiguous United States contact Liebert Global Services, if available in your area. For international areas not covered by Liebert Global Services, the Liebert authorized distributor can provide technical support.

This event was written to the Event Log, if so configured.

The alarm has triggered a message to be sent to the modem, if so configured.

If configured to be a latching alarm, press RESET on the display. If you are accessing the unit from a terminal, type **CA** and press RETURN on your keyboard.

INTERNAL COMM FAIL

Internal CAN Communications Failed

Communications have failed in the CAN bus between the control board and the touch screen control.

Press SILENCE on the touch screen to turn off the audible alarm, if so configured. If you are accessing the STS2/PDU system from a terminal, type **SH** and press RETURN on your keyboard to turn off the audible alarm.

Contact technical support; in the United States, call 1-800-LIEBERT (1-800-543-2378). Outside the 48 contiguous United States contact Liebert Global Services, if available in your area. For international areas not covered by Liebert Global Services, the Liebert authorized distributor can provide technical support.

This event was written to the Event Log, if so configured.

The alarm has triggered a message to be sent to the modem, if so configured.

If configured to be a latching alarm, press RESET on the display. If you are accessing the unit from a terminal, type **CA** and press RETURN on your keyboard.

CB1 SHUNT TRIP FAIL

Circuit Breaker 1 Shunt Trip Failure

Circuit Breaker 1 failed to trip open when the control issued a command for the circuit breaker to trip.

Press SILENCE on the touch screen to turn off the audible alarm, if so configured. If you are accessing the STS2/PDU system from a terminal, type **SH** and press RETURN on your keyboard to turn off the audible alarm.

Contact technical support; in the United States, call 1-800-LIEBERT (1-800-543-2378). Outside the 48 contiguous United States contact Liebert Global Services, if available in your area. For international areas not covered by Liebert Global Services, the Liebert authorized distributor can provide technical support.

This event was written to the Event Log, if so configured.

The alarm has triggered a message to be sent to the modem, if so configured.

If configured to be a latching alarm, press RESET on the display. If you are accessing the unit from a terminal, type **CA** and press RETURN on your keyboard.

CB2 SHUNT TRIP FAIL

Circuit Breaker 2 Shunt Trip Failure

Circuit Breaker 2 failed to trip open when the control issued a command for the circuit breaker to trip.

Press SILENCE on the touch screen to turn off the audible alarm, if so configured. If you are accessing the STS2/PDU system from a terminal, type **SH** and press RETURN on your keyboard to turn off the audible alarm.

Contact technical support; in the United States, call 1-800-LIEBERT (1-800-543-2378). Outside the 48 contiguous United States contact Liebert Global Services, if available in your area. For international areas not covered by Liebert Global Services, the Liebert authorized distributor can provide technical support.

This event was written to the Event Log, if so configured.

The alarm has triggered a message to be sent to the modem, if so configured.

If configured to be a latching alarm, press RESET on the display. If you are accessing the unit from a terminal, type **CA** and press RETURN on your keyboard.

EQUIPMENT FAN FAILURE

Equipment Fan Failure

One of the equipment fans has failed.

Contact technical support; in the United States, call 1-800-LIEBERT (1-800-543-2378). Outside the 48 contiguous United States contact Liebert Global Services, if available in your area. For international areas not covered by Liebert Global Services, the Liebert authorized distributor can provide technical support.

Press SILENCE on the touch screen to turn off the audible alarm, if so configured. If you are accessing the STS2/PDU system from a terminal, type **SH** and press RETURN on your keyboard to turn off the audible alarm.

This event and the system status surrounding it have been written to a History Log if the History Logs were not already full. This event was also written to the Event Log, if so configured.

The alarm has triggered a message to be sent to the modem, if so configured.

INPUT 1 SURGE FAILURE

Input 1 Surge Failure

Source 1 input surge suppression module has failed.

Contact technical support; in the United States, call 1-800-LIEBERT (1-800-543-2378). Outside the 48 contiguous United States contact Liebert Global Services, if available in your area. For international areas not covered by Liebert Global Services, the Liebert authorized distributor can provide technical support.

Press SILENCE on the touch screen to turn off the audible alarm, if so configured. If you are accessing the STS2/PDU system from a terminal, type **SH** and press RETURN on your keyboard to turn off the audible alarm.

This event and the system status surrounding it have been written to a History Log if the History Logs were not already full. This event was also written to the Event Log, if so configured.

The alarm has triggered a message to be sent to the modem, if so configured.

INPUT 2 SURGE FAILURE

Input 2 Surge Failure

Source 2 input surge suppression module has failed.

Contact technical support; in the United States, call 1-800-LIEBERT (1-800-543-2378). Outside the 48 contiguous United States contact Liebert Global Services, if available in your area. For international areas not covered by Liebert Global Services, the Liebert authorized distributor can provide technical support.

Press SILENCE on the touch screen to turn off the audible alarm, if so configured. If you are accessing the STS2/PDU system from a terminal, type **SH** and press RETURN on your keyboard to turn off the audible alarm.

This event and the system status surrounding it have been written to a History Log if the History Logs were not already full. This event was also written to the Event Log, if so configured.

The alarm has triggered a message to be sent to the modem, if so configured.

HEAT SINK OVERTEMP

Heat Sink Over Temperature

The system heat sink temperature has exceeded the design limits.

Take immediate steps to cool the unit. Remove obstructions from the air inlet in the front of the unit. Remove and replace the air filter behind the front door. A standard furnace filter can be used.

Press SILENCE on the touch screen to turn off the audible alarm, if so configured. If you are accessing the STS2/PDU system from a terminal, type **SH** and press RETURN on your keyboard to turn off the audible alarm.

This event was written to the Event Log, if so configured.

The alarm has triggered a message to be sent to the modem, if so configured.

EQUIPMENT OVERTEMP

Equipment Over Temperature

Cabinet has exceeded the recommended temperature.

Contact technical support; in the United States, call 1-800-LIEBERT (1-800-543-2378). Outside the 48 contiguous United States contact Liebert Global Services, if available in your area. For international areas not covered by Liebert Global Services, the Liebert authorized distributor can provide technical support.

Press SILENCE on the touch screen to turn off the audible alarm, if so configured. If you are accessing the STS2/PDU system from a terminal, type **SH** and press RETURN on your keyboard to turn off the audible alarm.

This event and the system status surrounding it have been written to a History Log if the History Logs were not already full. This event was also written to the Event Log, if so configured.

S1 UV

Source 1 Under Voltage (fast detection).

The input voltage from Source 1 dropped below a set percentage of the nominal voltage, as set in the Fast UV setpoint under the User Settings. An S1 Fail alarm was also issued and source transfer has been inhibited.

The load of the STS2/PDU has been transferred to Source 2.

Press SILENCE on the touch screen to turn off the audible alarm, if so configured. If you are accessing the STS2/PDU system from a terminal, type **SH** and press RETURN on your keyboard to turn off the audible alarm.

This event was written to the Event Log, if so configured.

The alarm has triggered a message to be sent to the modem, if so configured.

If configured to be a latching alarm, press RESET on the display. If you are accessing the unit from a terminal, type **CA** and press RETURN on your keyboard.

S1 UV (RMS)

Source 1 Under Voltage (slow detection).

The input voltage from Source 1 remained below a set percentage of the nominal voltage for a designated period, as set in the Slow UV Setting and Slow UV Detection Delay setpoints configured under the User Settings. An S1 Fail alarm was also issued and source transfer has been inhibited.

The load of the STS2/PDU has been transferred to Source 2.

Press SILENCE on the touch screen to turn off the audible alarm, if so configured. If you are accessing the STS2/PDU system from a terminal, type **SH** and press RETURN on your keyboard to turn off the audible alarm.

The alarm is latched and must be reset after the voltage returns to the nominal voltage. If the Reset option is not configured for AUTO (automatic reset), then the reset action must be done manually. When the voltage is within acceptable parameters, touch the RESET button on the touch screen. If you are accessing the unit from a terminal, type **CA** and press RETURN on your keyboard.

This event was written to the Event Log, if so configured.

The alarm has triggered a message to be sent to the modem, if so configured.

S1 OV

Source 1 Over Voltage.

The input voltage from Source 1 exceeded a set percentage of the nominal voltage, as set in the OV Setting and OV Detection Delay setpoints configured under the User Settings. An S1 Fail alarm was also issued and source transfer has been inhibited.

The load of the STS2/PDU has been transferred to Source 2.

Press SILENCE on the touch screen to turn off the audible alarm, if so configured. If you are accessing the STS2/PDU system from a terminal, type **SH** and press RETURN on your keyboard to turn off the audible alarm.

This event was written to the Event Log, if so configured.

The alarm has triggered a message to be sent to the modem, if so configured.

If configured to be a latching alarm, press RESET on the display. If you are accessing the unit from a terminal, type **CA** and press RETURN on your keyboard.

S1 OF/UF

Source 1 Over Frequency/Under Frequency

The frequency for Source 1 is running outside the acceptable operating range, as set in the Frequency Trip Point under User Settings. An S1 Fail alarm was also issued and source transfer has been inhibited.

Press SILENCE on the touch screen to turn off the audible alarm, if so configured. If you are accessing the STS2/PDU system from a terminal, type **SH** and press RETURN on your keyboard to turn off the audible alarm.

This event was written to the Event Log, if so configured.

The alarm has triggered a message to be sent to the modem, if so configured.

If configured to be a latching alarm, press RESET on the display. If you are accessing the unit from a terminal, type **CA** and press RETURN on your keyboard.

S1 FAIL

Source 1 Failure

Source 1 has failed due to under voltage (UV), over voltage (OV) or from running over or under frequency (OF/UF). This alarm is a companion to S1 UV, S1 UV (RMS), S1 OV and S1 OF/UF.

The load of the STS2/PDU has been transferred to Source 2.

Press SILENCE on the touch screen to turn off the audible alarm, if so configured. If you are accessing the STS2/PDU system from a terminal, type **SH** and press RETURN on your keyboard to turn off the audible alarm.

This event has been written to the Event Log, if so configured.

The alarm has triggered a message to be sent to the modem, if so configured.

If configured to be a latching alarm, press RESET on the display. If you are accessing the unit from a terminal, type **CA** and press RETURN on your keyboard.

S2 UV

Source 2 Under Voltage (fast detection).

The input voltage from Source 2 dropped below a set percentage of the nominal voltage, as set in the Fast UV setpoint under the User Settings. An S2 Fail alarm was also issued and source transfer has been inhibited.

The load of the STS2/PDU has been transferred to Source 1.

Press SILENCE on the touch screen to turn off the audible alarm, if so configured. If you are accessing the STS2/PDU system from a terminal, type **SH** and press RETURN on your keyboard to turn off the audible alarm.

This event was written to the Event Log, if so configured.

The alarm has triggered a message to be sent to the modem, if so configured.

If configured to be a latching alarm, press RESET on the display. If you are accessing the unit from a terminal, type **CA** and press RETURN on your keyboard.

S2 UV (RMS)

Source 2 Under Voltage (slow detection).

The input voltage from Source 2 remained below a set percentage of the nominal voltage for a designated period, as set in the Slow UV Setting and Slow UV Detection Delay setpoints configured under the User Settings. An S2 Fail alarm was also issued and source transfer has been inhibited.

The load of the STS2/PDU has been transferred to Source 1.

Press SILENCE on the touch screen to turn off the audible alarm, if so configured. If you are accessing the STS2/PDU system from a terminal, type **SH** and press RETURN on your keyboard to turn off the audible alarm.

The alarm is latched and must be reset after the voltage returns to the nominal voltage. If the Reset option is not configured for AUTO (automatic reset), then the reset action must be done manually. When the voltage is within acceptable parameters, touch the RESET button on the touch screen. If you are accessing the unit from a terminal, type **CA** and press RETURN on your keyboard.

This event was written to the Event Log, if so configured.

S2 OV

Source 2 Over Voltage.

The input voltage from Source 2 exceeded a set percentage of the nominal voltage, as set in the OV Setting and OV Detection Delay setpoints configured under the User Settings. An S2 Fail alarm was also issued and source transfer has been inhibited.

The load of the STS2/PDU has been transferred to Source 1.

Press SILENCE on the touch screen to turn off the audible alarm, if so configured. If you are accessing the STS2/PDU system from a terminal, type **SH** and press RETURN on your keyboard to turn off the audible alarm.

This event was written to the Event Log, if so configured.

The alarm has triggered a message to be sent to the modem, if so configured.

If configured to be a latching alarm, press RESET on the display. If you are accessing the unit from a terminal, type **CA** and press RETURN on your keyboard.

S2 UF/OF

Source 2 Under Frequency/Over Frequency

The frequency for Source 2 is running outside the acceptable operating range, as set in the Frequency Trip Point under User Settings. An S2 Fail alarm was also issued and source transfer has been inhibited.

Press SILENCE on the touch screen to turn off the audible alarm, if so configured. If you are accessing the STS2/PDU system from a terminal, type **SH** and press RETURN on your keyboard to turn off the audible alarm.

This event was written to the Event Log, if so configured.

The alarm has triggered a message to be sent to the modem, if so configured.

If configured to be a latching alarm, press RESET on the display. If you are accessing the unit from a terminal, type **CA** and press RETURN on your keyboard.

S2 FAIL

Source 2 Failure

Source 2 has failed due to under voltage (UV), over voltage (OV) or running with an over or under frequency (OF/UF).

This alarm is a companion to S2 UV, S2 UV (RMS), S2 OV and S2 OF/UF.

The load of the STS2/PDU has been transferred to Source 1.

Press SILENCE on the touch screen to turn off the audible alarm, if so configured. If you are accessing the STS2/PDU system from a terminal, type **SH** and press RETURN on your keyboard to turn off the audible alarm.

This event was written to the Event Log, if so configured.

The alarm has triggered a message to be sent to the modem, if so configured.

If configured to be a latching alarm, press RESET on the display. If you are accessing the unit from a terminal, type **CA** and press RETURN on your keyboard.

S1 OVERCURRENT

Source 1 Overcurrent

STS2/PDU is running on Source 1 and an overload condition has occurred on one or more phases.

Note: The overload setpoint is a single fixed number—101%. An overload condition is detected when the measured load current is equal to or greater than the setpoint.

Press SILENCE on the touch screen to turn off the audible alarm, if so configured. If you are accessing the STS2/PDU system from a terminal, type **SH** and press RETURN on your keyboard to turn off the audible alarm.

This event was written to the Event Log, if so configured.

The alarm has triggered a message to be sent to the modem, if so configured.

If configured to be a latching alarm, press RESET on the display. If you are accessing the unit from a terminal, type **CA** and press RETURN on your keyboard.

S2 OVERCURRENT

Source 1 Overcurrent

STS2/PDU is running on Source 2 and an overload condition has occurred on one or more phases.

Note: The overload setpoint is a single fixed number—101%. An overload condition is detected when the measured load current is equal to or greater than the setpoint.

Press SILENCE on the touch screen to turn off the audible alarm, if so configured. If you are accessing the STS2/PDU system from a terminal, type **SH** and press RETURN on your keyboard to turn off the audible alarm.

This event was written to the Event Log, if so configured.

The alarm has triggered a message to be sent to the modem, if so configured.

If configured to be a latching alarm, press RESET on the display. If you are accessing the unit from a terminal, type **CA** and press RETURN on your keyboard.

S1 I-PEAK

Current Peak on Source 1

The peak current from Source 1 has exceeded the setpoint as defined in the I-PK Xfer Lockout setting under User Settings.

Transferring to Source 2 has been inhibited.

Press SILENCE on the touch screen to turn off the audible alarm, if so configured. If you are accessing the STS2/PDU system from a terminal, type **SH** and press RETURN on your keyboard to turn off the audible alarm.

This event and the system status surrounding it have been written to a History Log if the History Logs were not already full. This event was also written to the Event Log, if so configured.

If this alarm is configured to automatically reset under the setpoints for User Settings, the alarm clears itself when the I-Peak condition clears.

If this alarm is set for manual reset mode, the alarm continues to show as active after the current returns to nominal, still inhibiting transfers. You will need to manually reset the alarm. If configured to be a latching alarm, press RESET on the display. If you are accessing the unit from a terminal, type **CA** and press RETURN on your keyboard.

The alarm has triggered a message to be sent to the modem, if so configured.

S2 I-PEAK

Current Peak on Source 2

The peak current from Source 2 has exceeded the setpoint as defined in the I-PK Xfer Lockout setting under User Settings.

Transferring to Source 1 has been inhibited.

Press SILENCE on the touch screen to turn off the audible alarm, if so configured. If you are accessing the STS2/PDU system from a terminal, type **SH** and press RETURN on your keyboard to turn off the audible alarm.

This event and the system status surrounding it have been written to a History Log if the History Logs were not already full. This event was also written to the Event Log, if so configured.

If this alarm is configured to automatically reset under the setpoints for User Settings, the alarm clears itself when the I-Peak condition clears.

If this alarm is set for manual reset mode, the alarm continues to show as active after the current returns to nominal,

still inhibiting transfers. You will need to manually reset the alarm. If configured to be a latching alarm, press RESET on the display. If you are accessing the unit from a terminal, type **CA** and press RETURN on your keyboard.

The alarm has triggered a message to be sent to the modem, if so configured.

SOURCES OUT OF SYNC

Sources out of synchronization.

The phase difference between Source 1 and Source 2 has exceeded the deviation as set for MANUAL MAX XFER PHASE ANGLE under User Settings.

A manual transfer cannot take place while the sources are not synchronized.

Press SILENCE on the touch screen to turn off the audible alarm, if so configured. If you are accessing the STS2/PDU system from a terminal, type **SH** and press RETURN on your keyboard to turn off the audible alarm.

The event was written to the Event Log, if so configured.

The alarm has triggered a message to be sent to the modem, if so configured.

If configured to be a latching alarm, press RESET on the display. If you are accessing the unit from a terminal, type **CA** and press RETURN on your keyboard.

LOAD ON ALT SOURCE

STS2/PDU load on the alternate source.

The Static Transfer Switch 2 Power Distribution Unit is running on the alternate power source. Check the Event Log to determine the reason for the transfer from the preferred source.

Another event has caused the system to transfer to the alternate source. The system returns the load to the preferred source either automatically or manually, depending on how the system is configured.

In automatic reset mode, the STS2/PDU automatically retransfers to the preferred source after the causal condition clears.

In manual reset mode, the system remains on the alternate source after the causal event clears until you select RESET from the touchscreen or enter CA (Clear Alarms) from a service terminal.



NOTE

Pressing the RESET button returns the unit to the preferred source. Ensure that the condition that triggered the switch has been rectified before returning to the preferred source.

Press SILENCE on the touch screen to turn off the audible alarm, if so configured. If you are accessing the STS2/PDU system from a terminal, type **SH** and press RETURN on your keyboard to turn off the audible alarm.

This event was written to the Event Log, if so configured.

The alarm has triggered a message to be sent to the modem, if so configured.

AUTO REXFER INHIBIT

Automatic Retransfer Inhibited.

The system made five transfers from the preferred source to the alternate source in the last five minutes. As a result, automatic retransfers back to the preferred source is now disabled.

To clear this alarm condition, assign the alternate source as the preferred source.

This alarm also is cleared if the unit transfers to the preferred source due to an alternate source AC volt failure (i.e., an emergency transfer.)

Press SILENCE on the touch screen to turn off the audible alarm, if so configured. If you are accessing the STS2/PDU system from a terminal, type **SH** and press RETURN on your keyboard to turn off the audible alarm.

The event was written to the Event Log, if so configured.

The alarm has triggered a message to be sent to the modem, if so configured.

If configured to be a latching alarm, press RESET on the display. If you are accessing the unit from a terminal, type **CA** and press RETURN on your keyboard.

CB1 (S1) OPEN

Circuit Breaker 1 (for Source 1) Open

Circuit Breaker 1 is not closed. CB1 is only assigned to Source 1.

Check that the Circuit Breaker 1 switch is in the desired position.

Press SILENCE on the touch screen to turn off the audible alarm, if so configured. If you are accessing the STS2/PDU system from a terminal, type **SH** and press RETURN on your keyboard to turn off the audible alarm.

This event was written to the Event Log, if so configured.

The alarm has triggered a message to be sent to the modem, if so configured.

If configured to be a latching alarm, press RESET on the display. If you are accessing the unit from a terminal, type **CA** and press RETURN on your keyboard.

CB2 (S2) OPEN

Circuit Breaker 2 (for Source 2) Open

Circuit Breaker 2 is not closed. CB1 is only assigned to Source 2.

Check that the Circuit Breaker 2 switch is in the desired position.

Press SILENCE on the touch screen to turn off the audible alarm, if so configured. If you are accessing the STS2/PDU system from a terminal, type **SH** and press RETURN on your keyboard to turn off the audible alarm.

This event was written to the Event Log, if so configured.

The alarm has triggered a message to be sent to the modem, if so configured.

If configured to be a latching alarm, press RESET on the display. If you are accessing the unit from a terminal, type **CA** and press RETURN on your keyboard.

CB4 (S1 BYP) CLOSED

Circuit Breaker 4 (Source 1 Bypass Breaker) Closed

Circuit breaker 4 is not open. The input from Source 1 is bypassing the Static Transfer Switch 2 Power Distribution Unit.

Press SILENCE on the touch screen to turn off the audible alarm, if so configured. If you are accessing the STS2/PDU system from a terminal, type **SH** and press RETURN on your keyboard to turn off the audible alarm.

This event was written to the Event Log, if so configured.

The alarm has triggered a message to be sent to the modem, if so configured.

If configured to be a latching alarm, press RESET on the display. If you are accessing the unit from a terminal, type **CA** and press RETURN on your keyboard.

CB5 (S1 BYP) CLOSED

Circuit Breaker 5 (Source 2 Bypass Breaker) Closed

Circuit breaker 5 is not open. The input from Source 2 is bypassing the Static Transfer Switch 2 Power Distribution Unit.

Press SILENCE on the touch screen to turn off the audible alarm, if so configured. If you are accessing the STS2/PDU system from a terminal, type **SH** and press RETURN on your keyboard to turn off the audible alarm.

This event was written to the Event Log, if so configured.

The alarm has triggered a message to be sent to the modem, if so configured.

If configured to be a latching alarm, press RESET on the display. If you are accessing the unit from a terminal, type **CA** and press RETURN on your keyboard.

CB3 (OUTPUT) OPEN

Circuit Breaker 3 (Output breaker) Open

Circuit breaker 3 is not closed. This circuit breaker is assigned to the output load. The power flow to the load cannot flow through the Static Transfer Switch 2 Power Distribution Unit.

Press SILENCE on the touch screen to turn off the audible alarm, if so configured. If you are accessing the STS2/PDU system from a terminal, type **SH** and press RETURN on your keyboard to turn off the audible alarm.

This event was written to the Event Log, if so configured.

The alarm has triggered a message to be sent to the modem, if so configured.

If configured to be a latching alarm, press RESET on the display. If you are accessing the unit from a terminal, type **CA** and press RETURN on your keyboard.

CB3A (OUTPUT) OPEN

Circuit Breaker 3A (Output breaker) is Open (Optional)

Circuit breaker 3A is not closed. This circuit breaker is assigned to the output load. The power flow to the load cannot flow through the Static Transfer Switch 2 Power Distribution Unit.

Press SILENCE on the touch screen to turn off the audible alarm, if so configured. If you are accessing the STS2/PDU system from a terminal, type **SH** and press RETURN on your keyboard to turn off the audible alarm.

This event was written to the Event Log, if so configured.

The alarm has triggered a message to be sent to the modem, if so configured.

If configured to be a latching alarm, press RESET on the display. If you are accessing the unit from a terminal, type **CA** and press RETURN on your keyboard.

S1 PHASE ROT ERROR

Source 1 Phase Rotation Error

A phase rotation error condition exists on Source 1. Check the phase sequence (ABC) of Source 1.

Transferring to Source 1 has been inhibited.

Press SILENCE on the touch screen to turn off the audible alarm, if so configured. If you are accessing the STS2/PDU system from a terminal, type **SH** and press RETURN on your keyboard to turn off the audible alarm.

This event was written to the Event Log, if so configured.

The alarm has triggered a message to be sent to the modem, if so configured.

If configured to be a latching alarm, press RESET on the display. If you are accessing the unit from a terminal, type **CA** and press RETURN on your keyboard.

S2 PHASE ROT ERROR

Source 2 Phase Rotation Error

A phase rotation error condition exists on Source 2. Check the phase sequence (ABC) of Source 2.

Transferring to Source 1 has been inhibited.

Press SILENCE on the touch screen to turn off the audible alarm, if so configured. If you are accessing the STS2/PDU system from a terminal, type **SH** and press RETURN on your keyboard to turn off the audible alarm.

This event was written to the Event Log, if so configured.

The alarm has triggered a message to be sent to the modem, if so configured.

If configured to be a latching alarm, press RESET on the display. If you are accessing the unit from a terminal, type **CA** and press RETURN on your keyboard.

TRANSFER INHIBITED

Transfer Inhibited

Uninterrupted transfer between sources is inhibited due to input source failure, sources out of sync, switch failure or the unit is in bypass mode.

Check the Event Log for the event or events that may have caused the alarm.

Press SILENCE on the touch screen to turn off the audible alarm, if so configured. If you are accessing the STS2/PDU system from a terminal, type **SH** and press RETURN on your keyboard to turn off the audible alarm.

This event was written to the Event Log, if so configured.

The alarm has triggered a message to be sent to the modem, if so configured.

If configured to be a latching alarm, press RESET on the display. If you are accessing the unit from a terminal, type **CA** and press RETURN on your keyboard.

OUTPUT UV

Output Undervoltage

The voltage being supplied to the load has dropped below the acceptable nominal voltage. Check the input voltage from both sources.

This event and the system status surrounding it have been written to a History Log if the History Logs were not already full. This event was also written to the Event Log, if so configured.

Press SILENCE on the touch screen to turn off the audible alarm, if so configured. If you are accessing the STS2/PDU system from a terminal, type **SH** and press RETURN on your keyboard to turn off the audible alarm.

The alarm has triggered a message to be sent to the modem, if so configured.

If configured to be a latching alarm, press RESET on the display. If you are accessing the unit from a terminal, type **CA** and press RETURN on your keyboard.

HISTORY LOG FROZEN

History Log Frozen

Both History Logs have been written and no more history logs can be written without clearing one of the logs.

Contact technical support; in the United States, call 1-800-LIEBERT (1-800-543-2378). Outside the 48 contiguous United States contact Liebert Global Services, if available in your area. For international areas not covered by Liebert Global Services, the Liebert authorized distributor can provide technical support.

Press SILENCE on the touch screen to turn off the audible alarm, if so configured. If you are accessing the STS2/PDU system from a terminal, type **SH** and press RETURN on your keyboard to turn off the audible alarm.

This event and the system status surrounding it have been written to a History Log if the History Logs were not already full. This event was also written to the Event Log, if so configured.

INPUT 1 OVERVOLTAGE

Input 1 Overvoltage

Source 1 is over voltage.

Contact technical support; in the United States, call 1-800-LIEBERT (1-800-543-2378). Outside the 48 contiguous United States contact Liebert Global Services, if available in your area. For international areas not covered by Liebert Global Services, the Liebert authorized distributor can provide technical support.

Press SILENCE on the touch screen to turn off the audible alarm, if so configured. If you are accessing the STS2/PDU system from a terminal, type **SH** and press RETURN on your keyboard to turn off the audible alarm.

This event and the system status surrounding it have been written to a History Log if the History Logs were not already full. This event was also written to the Event Log, if so configured.

INPUT 1 UNDERVOLTAGE

Input 1 Undervoltage

Source 1 is under voltage.

Contact technical support; in the United States, call 1-800-LIEBERT (1-800-543-2378). Outside the 48 contiguous United States contact Liebert Global Services, if available in your area. For international areas not covered by Liebert Global Services, the Liebert authorized distributor can provide technical support.

Press SILENCE on the touch screen to turn off the audible alarm, if so configured. If you are accessing the STS2/PDU system from a terminal, type **SH** and press RETURN on your keyboard to turn off the audible alarm.

This event and the system status surrounding it have been written to a History Log if the History Logs were not already full. This event was also written to the Event Log, if so configured.

INPUT 2 OVERVOLTAGE

Input 2 Overvoltage

Source 2 is over voltage.

Contact technical support; in the United States, call 1-800-LIEBERT (1-800-543-2378). Outside the 48 contiguous United States contact Liebert Global Services, if available in your area. For international areas not covered by Liebert Global Services, the Liebert authorized distributor can provide technical support.

Press SILENCE on the touch screen to turn off the audible alarm, if so configured. If you are accessing the STS2/PDU system from a terminal, type **SH** and press RETURN on your keyboard to turn off the audible alarm.

This event and the system status surrounding it have been written to a History Log if the History Logs were not already full. This event was also written to the Event Log, if so configured.

INPUT 2 UNDERVOLTAGE

Input 2 Undervoltage

Source 2 is under voltage.

Contact technical support; in the United States, call 1-800-LIEBERT (1-800-543-2378). Outside the 48 contiguous United States contact Liebert Global Services, if available in your area. For international areas not covered by Liebert Global Services, the Liebert authorized distributor can provide technical support.

Press SILENCE on the touch screen to turn off the audible alarm, if so configured. If you are accessing the STS2/PDU system from a terminal, type **SH** and press RETURN on your keyboard to turn off the audible alarm.

This event and the system status surrounding it have been written to a History Log if the History Logs were not already full. This event was also written to the Event Log, if so configured.

LOAD OVERCURRENT

Load Overcurrent

Output is over current.

Contact technical support; in the United States, call 1-800-LIEBERT (1-800-543-2378). Outside the 48 contiguous United States contact Liebert Global Services, if available in your area. For international areas not covered by Liebert Global Services, the Liebert authorized distributor can provide technical support.

Press SILENCE on the touch screen to turn off the audible alarm, if so configured. If you are accessing the STS2/PDU system from a terminal, type **SH** and press RETURN on your keyboard to turn off the audible alarm.

This event and the system status surrounding it have been written to a History Log if the History Logs were not already full. This event was also written to the Event Log, if so configured.

GROUND OVERCURRENT

Ground Overcurrent

Ground is over current.

Contact technical support; in the United States, call 1-800-LIEBERT (1-800-543-2378). Outside the 48 contiguous United States contact Liebert Global Services, if available in your area. For international areas not covered by Liebert Global Services, the Liebert authorized distributor can provide technical support.

Press SILENCE on the touch screen to turn off the audible alarm, if so configured. If you are accessing the STS2/PDU system from a terminal, type **SH** and press RETURN on your keyboard to turn off the audible alarm.

This event and the system status surrounding it have been written to a History Log if the History Logs were not already full. This event was also written to the Event Log, if so configured.

NEUTRAL OVERCURRENT

Neutral Overcurrent

Neutral is over current.

Contact technical support; in the United States, call 1-800-LIEBERT (1-800-543-2378). Outside the 48 contiguous United States contact Liebert Global Services, if available in your area. For international areas not covered by Liebert Global Services, the Liebert authorized distributor can provide technical support.

Press SILENCE on the touch screen to turn off the audible alarm, if so configured. If you are accessing the STS2/PDU system from a terminal, type **SH** and press RETURN on your keyboard to turn off the audible alarm.

This event was also written to the Event Log, if so configured.

LOAD VOLTAGE THD

Load Voltage Total Harmonic Distortion

Voltage THD has exceeded the set limit.

Contact technical support; in the United States, call 1-800-LIEBERT (1-800-543-2378). Outside the 48 contiguous United States contact Liebert Global Services, if available in your area. For international areas not covered by Liebert Global Services, the Liebert authorized distributor can provide technical support.

Press SILENCE on the touch screen to turn off the audible alarm, if so configured. If you are accessing the STS2/PDU system from a terminal, type **SH** and press RETURN on your keyboard to turn off the audible alarm.

This event was also written to the Event Log, if so configured.

INPUT 1 CB6 OPEN

Input 1 CB6 Open

Source 1 input Circuit Breaker 6 is open.

Contact technical support; in the United States, call 1-800-LIEBERT (1-800-543-2378). Outside the 48 contiguous United States contact Liebert Global Services, if available in your area. For international areas not covered by Liebert Global Services, the Liebert authorized distributor can provide technical support.

Press SILENCE on the touch screen to turn off the audible alarm, if so configured. If you are accessing the STS2/PDU system from a terminal, type **SH** and press RETURN on your keyboard to turn off the audible alarm.

This event was also written to the Event Log, if so configured.

INPUT 2 CB7 OPEN

Input 2 CB7 Open

Source 2 Input Circuit Breaker 7 is open.

Contact technical support; in the United States, call 1-800-LIEBERT (1-800-543-2378). Outside the 48 contiguous United States contact Liebert Global Services, if available in your area. For international areas not covered by Liebert Global Services, the Liebert authorized distributor can provide technical support.

Press SILENCE on the touch screen to turn off the audible alarm, if so configured. If you are accessing the STS2/PDU system from a terminal, type **SH** and press RETURN on your keyboard to turn off the audible alarm.

This event was also written to the Event Log, if so configured.

INPUT 1 OF/UF

Input 1 Over Frequency/Under Frequency

Source 1 is over frequency/under frequency

Contact technical support; in the United States, call 1-800-LIEBERT (1-800-543-2378). Outside the 48 contiguous United States contact Liebert Global Services, if available in your area. For international areas not covered by Liebert Global Services, the Liebert authorized distributor can provide technical support.

Press SILENCE on the touch screen to turn off the audible alarm, if so configured. If you are accessing the STS2/PDU system from a terminal, type **SH** and press RETURN on your keyboard to turn off the audible alarm.

This event was also written to the Event Log, if so configured.

INPUT 2 OF/UF

Input 2 Over Frequency/Under Frequency

Source 2 is over frequency/under frequency.

Contact technical support; in the United States, call 1-800-LIEBERT (1-800-543-2378). Outside the 48 contiguous United States contact Liebert Global Services, if available in your area. For international areas not covered by Liebert Global Services, the Liebert authorized distributor can provide technical support.

Press SILENCE on the touch screen to turn off the audible alarm, if so configured. If you are accessing the STS2/PDU system from a terminal, type **SH** and press RETURN on your keyboard to turn off the audible alarm.

This event was also written to the Event Log, if so configured.

INPUT CONTACT #1

Input Contact Isolator #1

Occurrence of the indicated external event has been detected by Input Contact Isolator #1 of the Open Comms Digital Input option board.

Press SILENCE on the touch screen to turn off the audible alarm, if so configured. If you are accessing the STS2/PDU system from a terminal, type **SH** and press RETURN on your keyboard to turn off the audible alarm.

The event, with its assigned name, was written to the Event Log, if so configured.

The alarm has triggered a message to be sent to the modem, if so configured.

If configured to be a latching alarm, press RESET on the display. If you are accessing the unit from a terminal, type **CA** and press RETURN on your keyboard.

INPUT CONTACT #2

Input Contact Isolator #2

Occurrence of the indicated external event has been detected by Input Contact Isolator #2 of the Open Comms Digital Input option board.

Press SILENCE on the touch screen to turn off the audible alarm, if so configured. If you are accessing the STS2/PDU system from a terminal, type **SH** and press RETURN on your keyboard to turn off the audible alarm.

The event, with its assigned name, was written to the Event Log, if so configured.

The alarm has triggered a message to be sent to the modem, if so configured.

If configured to be a latching alarm, press RESET on the display. If you are accessing the unit from a terminal, type **CA** and press RETURN on your keyboard.

INPUT CONTACT #3

Input Contact Isolator #3

Occurrence of the indicated external event has been detected by Input Contact Isolator #3 of the Open Comms Digital Input option board.

Press SILENCE on the touch screen to turn off the audible alarm, if so configured. If you are accessing the STS2/PDU system from a terminal, type **SH** and press RETURN on your keyboard to turn off the audible alarm.

The event, with its assigned name, was written to the Event Log, if so configured.

The alarm has triggered a message to be sent to the modem, if so configured.

If configured to be a latching alarm, press RESET on the display. If you are accessing the unit from a terminal, type **CA** and press RETURN on your keyboard.

INPUT CONTACT #4

Input Contact Isolator #4

Occurrence of the indicated external event has been detected by Input Contact Isolator #4 of the Open Comms Digital Input option board.

Press SILENCE on the touch screen to turn off the audible alarm, if so configured. If you are accessing the STS2/PDU system from a terminal, type **SH** and press RETURN on your keyboard to turn off the audible alarm.

The event, with its assigned name, was written to the Event Log, if so configured.

The alarm has triggered a message to be sent to the modem, if so configured.

If configured to be a latching alarm, press RESET on the display. If you are accessing the unit from a terminal, type **CA** and press RETURN on your keyboard.

INPUT CONTACT #5

Input Contact Isolator #5

Occurrence of the indicated external event has been detected by Input Contact Isolator #5 of the Open Comms Digital Input option board.

Press SILENCE on the touch screen to turn off the audible alarm, if so configured. If you are accessing the STS2/PDU system from a terminal, type **SH** and press RETURN on your keyboard to turn off the audible alarm.

The event, with its assigned name, was written to the Event Log, if so configured.

The alarm has triggered a message to be sent to the modem, if so configured.

If configured to be a latching alarm, press RESET on the display. If you are accessing the unit from a terminal, type **CA** and press RETURN on your keyboard.

INPUT CONTACT #6

Input Contact Isolator #6

Occurrence of the indicated external event has been detected by Input Contact Isolator #6 of the Open Comms Digital Input option board.

Press SILENCE on the touch screen to turn off the audible alarm, if so configured. If you are accessing the STS2/PDU system from a terminal, type **SH** and press RETURN on your keyboard to turn off the audible alarm.

The event, with its assigned name, was written to the Event Log, if so configured.

The alarm has triggered a message to be sent to the modem, if so configured.

If configured to be a latching alarm, press RESET on the display. If you are accessing the unit from a terminal, type **CA** and press RETURN on your keyboard.

INPUT CONTACT #7

Input Contact Isolator #7

Occurrence of the indicated external event has been detected by Input Contact Isolator #7 of the Open Comms Digital Input option board.

Press SILENCE on the touch screen to turn off the audible alarm, if so configured. If you are accessing the STS2/PDU system from a terminal, type **SH** and press RETURN on your keyboard to turn off the audible alarm.

The event, with its assigned name, was written to the Event Log, if so configured.

The alarm has triggered a message to be sent to the modem, if so configured.

If configured to be a latching alarm, press RESET on the display. If you are accessing the unit from a terminal, type **CA** and press RETURN on your keyboard.

INPUT CONTACT #8

Input Contact Isolator #8

Occurrence of the indicated external event has been detected by Input Contact Isolator #8 of the Open Comms Digital Input option board.

Press SILENCE on the touch screen to turn off the audible alarm, if so configured. If you are accessing the STS2/PDU system from a terminal, type **SH** and press RETURN on your keyboard to turn off the audible alarm.

The event, with its assigned name, was written to the Event Log, if so configured.

The alarm has triggered a message to be sent to the modem, if so configured.

If configured to be a latching alarm, press RESET on the display. If you are accessing the unit from a terminal, type **CA** and press RETURN on your keyboard.

CONFIG MODIFIED

Configuration Modified

A setpoint has been updated and saved.

The event was written to the Event Log, if so configured.

PASSWORD CHANGED

Access Password Changed

The password for accessing the HMI (touch screen) options has been updated and saved.

The event was written to the Event Log, if so configured.

TIME REPROGRAMMED

System Time Reprogrammed

The system's time setting has been updated and saved.

The event was written to the Event Log, if so configured.

DATE REPROGRAMMED

System Date Reprogrammed

The system's date setting has been updated and saved.

The event was written to the Event Log, if so configured.

EVENT LOG CLEARED

Event Log Cleared

All past alarms and faults are no longer recorded in the system's event log.

This event was written to the Event Log, if so configured.

HIST LOGS CLEARED

History Logs Cleared

Both History Logs have been erased and the logs are now available to record future events.

The event was written to the Event Log, if so configured.

TRANSFER COUNTER CLEARED

Transfer Counter Cleared

Transfer counter reset to 0

Contact technical support; in the United States, call 1-800-LIEBERT (1-800-543-2378). Outside the 48 contiguous United States contact Liebert Global Services, if available in your area. For international areas not covered by Liebert Global Services, the Liebert authorized distributor can provide technical support.

This event was also written to the Event Log, if so configured.

KW-HRS COUNTER CLEARED

KW-HRS counter cleared

KW-Hrs counter reset to 0

Contact technical support; in the United States, call 1-800-LIEBERT (1-800-543-2378). Outside the 48 contiguous United States contact Liebert Global Services, if available in your area. For international areas not covered by Liebert Global Services, the Liebert authorized distributor can provide technical support.

This event was also written to the Event Log, if so configured.

16.0 MAINTENANCE



WARNING

Only qualified service personnel should perform maintenance on the STS2/PDU.

Lethal voltages exist inside the unit during normal operation.

The unit is supplied by multiple AC power sources. Disconnect and lock out all power sources before working inside unit.

Minimal periodic maintenance of the STS2/PDU is required. As with all electrical distribution components, the system should be regularly inspected for electrical connection integrity, signs of excessive temperatures, dirt accumulation and proper system operation.

16.1 Proper Tightening of Nuts and Bolts

The recommended tightening torque for all nuts and bolts is as shown below, unless otherwise labeled. All power connections are designed to remain at proper torque throughout the lifetime of the unit.

Table 29 Torque tightening

| Bolt Shaft Size | Grade 5 - Imperial Grade 8.8 - Metric | | Electrical Connections with Belleville Washers | |
|-----------------|--|-----------------------|---|-----------------------|
| | in-lb (pound-inch) | N-m (Newton-meter) | in-lb (pound-inch) | N-m (Newton-meter) |
| 10-32 | 25 | 3 | 35 | 4 |
| 1/4-20 | 53 | 6 | 80 | 9.0 |
| 5/16-18 | 107 | 12 | 180 | 20.4 |
| 3/8-16 | 192 | 22 | 240 | 27.1 |
| 1/2-13 | 428 | 48 | 480 | 54.3 |

Table 30 Branch circuit breakers

| Current Rating | in-lb (pound-inch) | N-m (Newton-meter) |
|----------------|-----------------------|-----------------------|
| Up to 30 Amp | 35 | 4.0 |
| 40 to 100 Amp | 45 | 5.1 |

16.2 Testing the STS2/PDU

The STS2/PDU includes comprehensive system alarms and fault detection to identify operational problems. To increase the degree of confidence of proper system operation, periodic transfer tests can be easily performed. For instructions for changing the preferred source and switching sources, see **10.2 - Manual Transfer / Preferred Source Selection**.

16.3 Changing the Air Filter

A standard furnace filter is installed behind the air intake in the front door. The air intake allows air to circulate to cool the unit. Replace the filter when it becomes dirty and impedes air flow. The frequency of changing or cleaning the filter depends on the location in which the unit is located. The size of the filter is 1 x 25 x 25 in. (254 x 635 x 635mm).

17.0 CUSTOMER SETTINGS

17.1 Programmable Relay Board Settings

The optional programmable relay board (PRB) has eight channels to report events to an external device. Up to ten (10) events can be programmed to each channel. See **6.1 - Programmable Relay Board** for more information on the PRB.

If your STS2/PDU has the PRB option installed, list the settings below for future reference. If control power is lost in the STS2/PDU, the settings are not saved.

Table 31 Programmable relay board settings record

| | | |
|------------------|--|--|
| Channel 1 | | |
| | | |
| | | |
| | | |
| | | |
| Channel 2 | | |
| | | |
| | | |
| | | |
| | | |
| Channel 3 | | |
| | | |
| | | |
| | | |
| | | |
| Channel 4 | | |
| | | |
| | | |
| | | |
| | | |
| Channel 5 | | |
| | | |
| | | |
| | | |
| | | |
| Channel 6 | | |
| | | |
| | | |
| | | |
| | | |

Table 31 Programmable relay board settings record

| | | |
|-------------------|-------|-------|
| Channel 7 | | |
| _____ | _____ | _____ |
| _____ | _____ | _____ |
| _____ | _____ | _____ |
| Channel 8 | | |
| _____ | _____ | _____ |
| _____ | _____ | _____ |
| _____ | _____ | _____ |
| Channel 9 | | |
| _____ | _____ | _____ |
| _____ | _____ | _____ |
| _____ | _____ | _____ |
| Channel 10 | | |
| _____ | _____ | _____ |
| _____ | _____ | _____ |
| _____ | _____ | _____ |
| PRB Notes | | |
| _____ | | |
| _____ | | |
| _____ | | |
| _____ | | |

17.2 Input Contact Isolator Settings

The Input Contact Isolator board (ICI) provides an STS2/PDU module interface for up to eight external user alarm or message inputs to be routed through the Static Transfer Switch 2 Power Distribution Unit’s alarm network. See **6.2 - Input Contact Isolator Board** for more information on the ICI.

If your STS2/PDU has the ICI option installed, list the settings below for future reference. If control power is lost in the STS2/PDU, the settings are not saved.

Table 32 Input contact isolator settings record

| | |
|------------------|-------|
| Channel 1 | _____ |
| Channel 2 | _____ |
| Channel 3 | _____ |
| Channel 4 | _____ |
| Channel 5 | _____ |
| Channel 6 | _____ |
| Channel 7 | _____ |
| Channel 8 | _____ |

STS2/PDU

INSTALLATION, OPERATION & MAINTENANCE MANUAL

The Company Behind the Products

With over a million installations around the globe, Liebert is the world leader in computer protection systems. Since its founding in 1965, Liebert has developed a complete range of support and protection systems for sensitive electronics:

- Environmental systems—close-control air conditioning from 1 to 60 tons
- Power conditioning and UPS with power ranges from 300 VA to more than 1000 kVA
- Integrated systems that provide both environmental and power protection in a single, flexible package
- Monitoring and control—from systems of any size or location, on-site or remote
- Service and support through more than 100 service centers around the world and a 24/7 Customer Response Center

While every precaution has been taken to ensure the accuracy and completeness of this literature, Liebert Corporation assumes no responsibility and disclaims all liability for damages resulting from use of this information or for any errors or omissions.

© 2003 Liebert Corporation

All rights reserved throughout the world. Specifications subject to change without notice.

® Liebert and the Liebert logo are registered trademarks of Liebert Corporation. All names referred to are trademarks or registered trademarks of their respective owners.

SL-20730 (2/04) Rev. 0

Technical Support/Service

Web Site

www.liebert.com

Monitoring

800-222-5877

monitoring@liebert.com

Outside the US: 614-841-6755

Single-Phase UPS

800-222-5877

upstech@liebert.com

Outside the US: 614-841-6755

Three-Phase UPS

800-543-2378

powertech@liebert.com

Environmental Systems

800-543-2778

Outside the United States

614-888-0246

Locations

United States

1050 Dearborn Drive

P.O. Box 29186

Columbus, OH 43229

Italy

Via Leonardo Da Vinci 8

Zona Industriale Tognana

35028 Piove Di Sacco (PD)

+39 049 9719 111

Fax: +39 049 5841 257

Asia

23F, Allied Kajima Bldg.

138 Gloucester Road

Wanchai

Hong Kong

+852 2 572 2201

Fax: +852 2 831 0114