

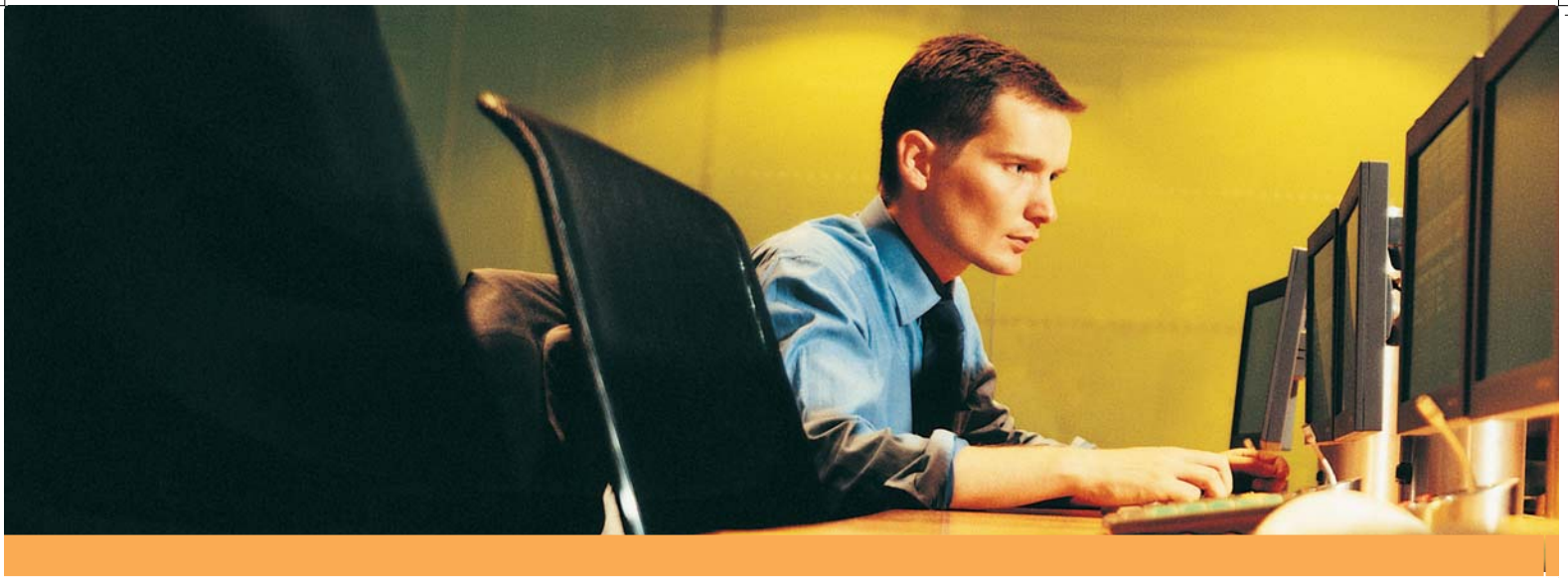

Power Protection for  
Business-Critical Continuity

## Liebert GXT-MT 1-3kVA UPS





## Trouble is Coming Down The Line And You Must Be Prepared

- Every operation in your business depends upon the instant, around-the clock availability of computers, servers and other electronic systems. If they aren't working, neither is your company.
- Every piece of this equipment your company possesses is subject to the whims of the electricity that powers it.
- The first step in taking control of this situation is to understand the threats to your system reliability — and exactly what you can do about them.

---

## The Liebert GXT-MT

### True Online Double Conversion UPS With Extended Runtime Capabilities

- **Liebert GXT-MT** features a comprehensive specification, satisfies international safety criteria and electromagnetic compatibility standards, and offers intelligent monitoring and network management functions.
- **Liebert GXT-MT** fully meets your requirements for high reliability and high availability of the AC power supply.
- **Liebert GXT-MT** is available in a compact tower configuration making it easily deployed in an office or a light industrial application.
- **Liebert GXT-MT** long run model (L) deploys adaptive battery architecture to maximise your valuable rack space utilisation. Application specific battery configuration and placement ensures optimal performance.

*NOTE: Liebert GXT-MT standard model is provided complete with internal battery  
Liebert GXTL-MT (long back up model) application specific battery and cabinet available through your local Emerson Network Power representative.*

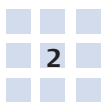

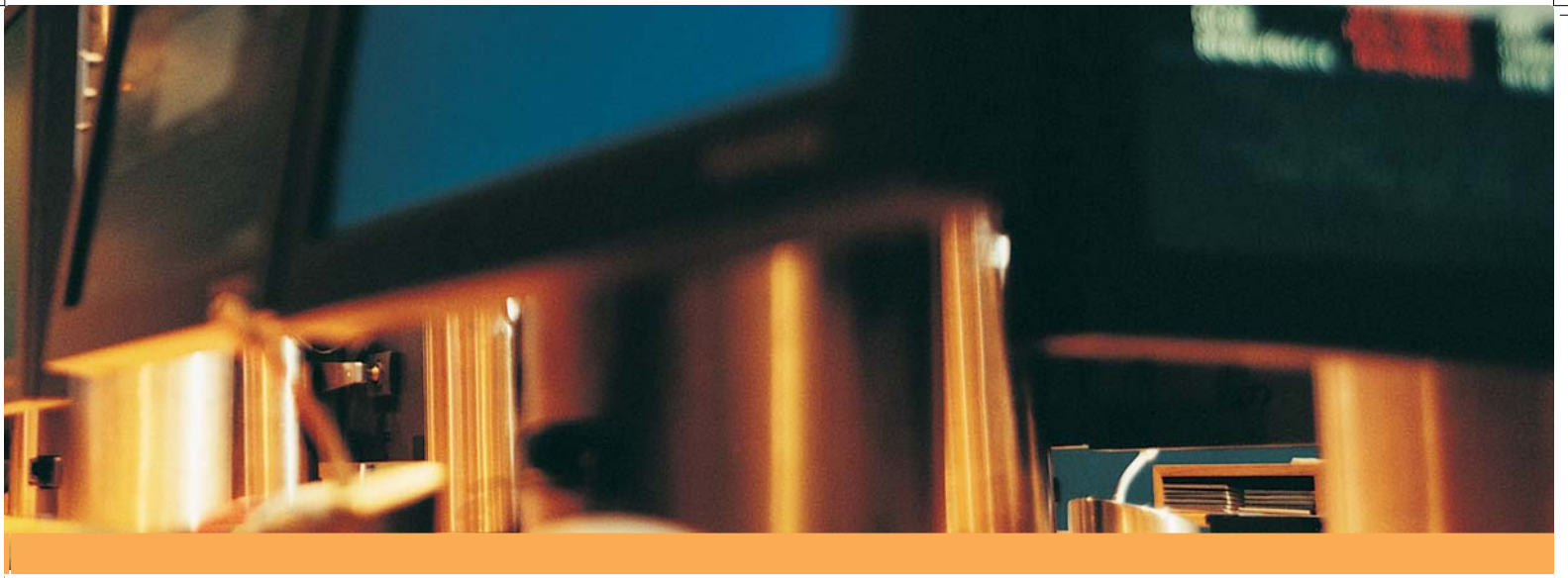

## Applications

- Small Size Data Center
- Telecommunication, VoIP
- Small Office Network
- Data Warehouses
- Medical Diagnostics
- Process Automation Equipments

## Features

- Extended Runtime Capabilities
- Flexible (Site Specific) Battery Configuration
- Compact Tower design.
- Generator Compatible
- "Mute" design
- Class B Electromagnetic interference (EMC) compatible
- Ultra wide input voltage range
- High capacity Battery Charger for GXTL
- High input power factor & low THDi



## Sourcing the Liebert GXT-RT



Available from all Uptime Partners



Email [marketing@emersonnetwork-ap.com](mailto:marketing@emersonnetwork-ap.com) for your nearest Uptime Partner

# Liebert GXT - MT

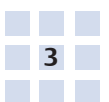

# True Online Double Conversion

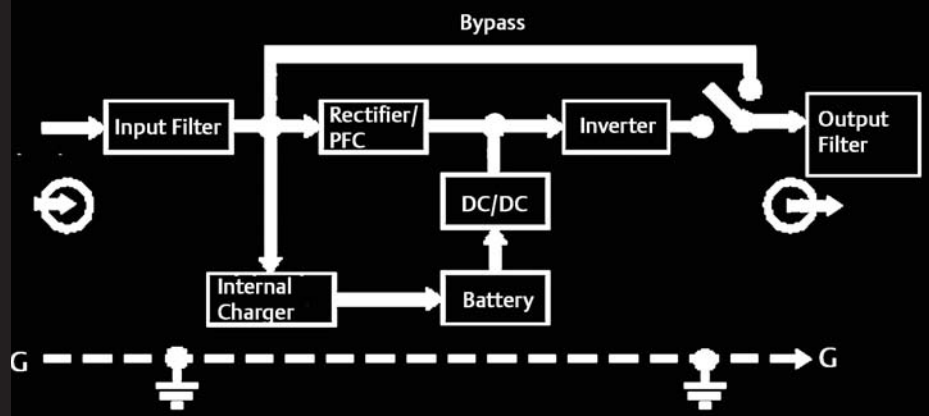

## Excellent performance

- True Online Double Conversion UPS with Zero transfer time. The online design ensures no output interruption upon mains failure, ensuring maximum uptime.
- Ultra wide input voltage range: 110~300V minimizes the battery discharge frequency, protects the battery capacity, and offers a super output overload capability. The system can maintain the online operation for up to 30 seconds even at 150% overload.
- High Capacity battery charging capability: **Liebert GXTL-MT** is equipped with a 4Amp (1kVA unit) and an 8Amp (2 and 3kVA unit) charger to ensure fast battery recovery as well as enabling extended battery autonomy.
- Electro Magnetic Conduction (EMC) compliant to Class B delivers strong immunity protection levels.
- Liebert GXT-MT** maintains a low level of Input current THD and highest possible Input power factor (up to 0.97), making it an energy efficient and conservative choice.



## High reliability Design

- Built-in automatic bypass assures power continuity during maintenance and system fault.
- The inverter uses advanced current limiting technology to protect the system against potential output short circuit.



## Flexible Configuration

- Extended Run Time ready facilitated through a simple process of building up additional battery resources.
- Multiple AC output interfaces via IEC standard sockets

## Convenient maintenance

- Fault type is clearly displayed for fast troubleshooting.
- LED display provides maximum operational convenience when managing the UPS.

## Convenient maintenance

- Stronger Battery charger on the GXT L model for quick recharge
- Remote Monitoring is available through RS232, and optional via dry contacts and SNMP. The monitoring option software supports TCP/IP with event log and analysis function.
- Self-diagnosis and protection enable the auto shutdown of the client terminal or server under abnormal mains supply or when battery is over discharged.

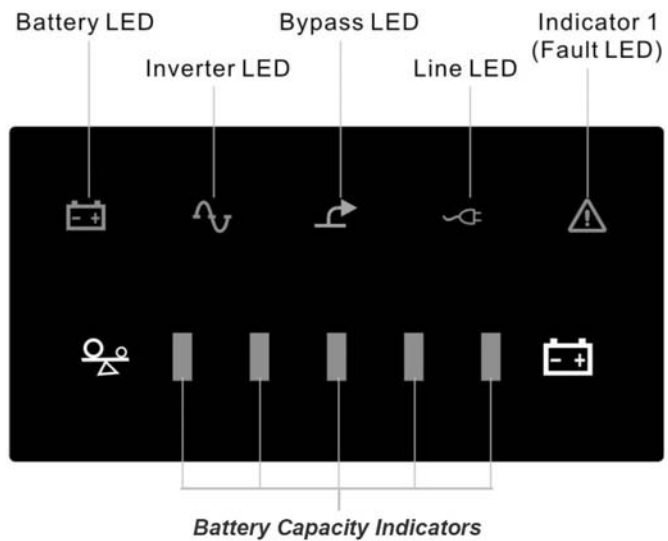

# True Online Double Conversion Technology: When “Adequate” protection is not enough

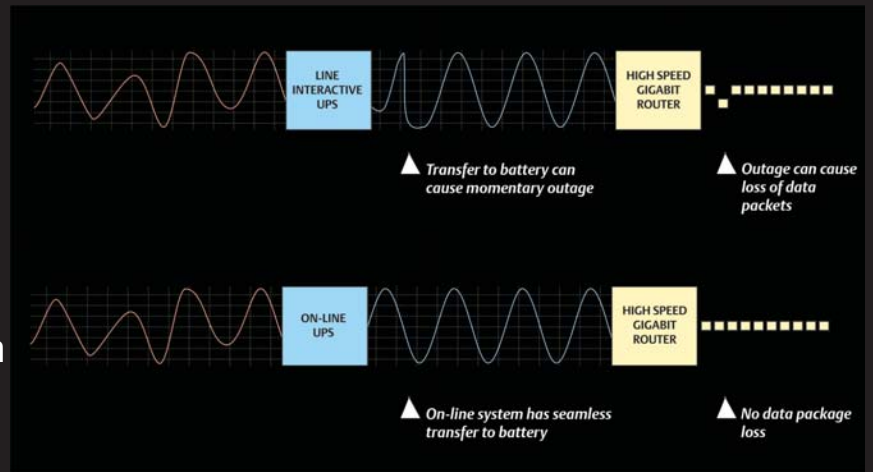

## Technical Specification, Liebert GXT-MT

Mechanical		
Module	W×H×D (mm)	Weight (kg)
Power module GXT1000-MT	145X220X400	14
Power module GXT1000L-MT	145X220X400	7
Power module GXT2000-MT	192X347X460	34.5
Power module GXT2000L-MT	192X347X460	15
Power module GXT3000-MT	192X347X460	35.5
Power module GXT3000L-MT	192X347X460	16
EMS		
Item	Standard	Level
ESD immunity	IEC61000-4-2	Level 4
RS immunity	IEC61000-4-3	Level 3
EFTB immunity	IEC61000-4-4	Level 4
Surge immunity	IEC61000-4-5	Level 4
EMI		
Item (for GXTL models)	Standard	Level
Limitation of emission of input harmonic currents	EN61000-3-2	-
Limitation of voltage changes, voltage fluctuations and flicker	EN61000-3-3	-
Conducted Emission	EN50091-2	Class B
Radiated Emission	EN50091-2	Class B
Environmental		
Item	Normal range	
Ambient temperature	0°C~40°C	
Relative humidity	Less than 90% Condensing	
Altitude	Lower than 1000m; no derating; 1000~1500m; 1% derating for every 100m rise	
Storage temperature	-0°C~40°C (excluding battery)	



Electrical							
Model	GXT 1000-MT	GXT 1000L-MT	GXT 2000-MT	GXT 2000L-MT	GXT 3000-MT	GXT 3000L-MT	
Rating	1000VA/700W		2000VA/1400W		3000VA/2100W		
Input	Input system	1-phase, plus PE					
	Rated voltage	220Vac / 230Vac / 240 Vac					
	Voltage range	1. 160~300 Vac full load 2. 110 Vac half load					
	Frequency	50/60 Hz					
	Power factor	0.97 (conditions: rated voltage, full pure resistive load, fully charged battery)					
Output	Output system	1-phase, plus PE					
	Power factor	0.7					
	Voltage	220Vac / 230 Vac / 240 Vac $\pm 2\%$					
	Line regulation	$\leq 2\%$ (0~100% linear load)					
	Voltage harmonic distortion (rated input voltage, rated input frequency)	$\leq 3\%$ (0~100% linear load)					
		$\leq 6\%$ (0~100% non-linear load)					
	Dynamic variation	$< 5\%$ in 20 ms					
	Frequency	50 / 60 Hz $\pm 0.2$ Hz					
	Frequency range	46-54 Hz / 56-64 Hz					
	Inverter overload capability (in Normal mode, 25°C)	108%~150% 30s					
		$> 150\%$ 300ms					
	Inverter overload capability (in Battery mode, 25°C)	108%~150% 30s					
		$> 150\%$ 300ms					
	Bypass overload capability	200% for $< 60$ mins					
		300% for 5s					
	Crest factor	3:1					
	Bypass operating voltage	80~264V					
	Transfer time	Normal $<$ □ $>$ Battery: 0ms					
DC component	$\leq 200$ mV						
Efficiency	Battery mode: $\geq 83\%$ (rated battery voltage, full linear load) Normal mode: $\geq 88\%$ (rated mains voltage, full linear load, battery fully charged)						
External battery voltage	36Vdc			96Vdc			
Charging current	1A	4A	1A	8A	1A	8A	
Battery	Qty. xVolts. xCapacity	3x12Vx7.2Ah	-	8X12X7.2Ah	-	8X12X7.2Ah	-
	Manufacturer / model	CSB/ GP1272F2 or Panasonic equivalent	-	CSB/GP1272F2 or Panasonic equivalent	-	CSB/ HRL1234WF2 or Panasonic equivalent	-
	Typical Autonomy Time	12 Minutes	-	15 Minutes	-	9 Minutes	-
	Autonomy at Half Load	20 Minutes	-	26 Minutes	-	16 Minutes	-
	Charging duration	80% of battery capacity in 4 hrs (standard type)					
Noise (within 1m)	GXT1000L-MT, GXT2000L-MT, GXT3000L-MT: $< 45$ db						

**Value-added Optional Parts:**

web/SNMP card  
ModBus Card

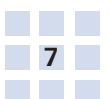



**Emerson Network Power**

1050 Dearborn Drive P.O. Box 29186 Columbus, Ohio 43229  
T: 614-8880246 F: 614-8416022  
T: 800-8779222 ( US and Canada Only)

**Emerson Network Power Asia Pacific Headquarters**

7/F, Dah Sing Financial Centre, 108 Gloucester Road, Wanchai, Hong Kong  
T: 852-25722201 F: 852-28310114

**Country Offices**

**Emerson Network Power (Australia) Pty Ltd**  
Block P, Regents Park Estate, 391 Park Road, Regents Park, Sydney, NSW 2143, Australia  
T: 61-1300367686 F: 61-2-97438737

**Emerson Network Power (China) Ltd**  
No.1 Kefa Road, Science & Industry Park, Nanshan District, Shenzhen 518057, China  
T: 86-755-86010808 F: 86-755-86010909

**Emerson Network Power (Hong Kong) Ltd**  
7/F, Dah Sing Financial Centre, 108 Gloucester Road, Wanchai, Hong Kong  
T: 852-25722201 F: 852-28310114

**Emerson Network Power (India) Private Ltd**  
Plot No. C-20, Road No. 19, Wagle Industrial Estate, Thane (West), Maharashtra 400604, India  
T: 91-22-25807000 / 2388 F: 91-22-25828358

**Emerson Network Power (Indonesia), c/o PT Emerson Indonesia**  
c/o PT Emerson Indonesia Wisma Pondok Indah 1st Floor, Jl. Sultan Iskandar Muda V TA, Jakarta 12310, Indonesia  
T: 62-21-7507800 F: 62-21-7507899

**Emerson Network Power Division / Emerson Japan Ltd**  
New Pier Takeshiba, South Tower 7F, 1-16-1 Kaigan, Minato-ku, Tokyo 105-0022, Japan  
T: 81-3-54038594 F: 81-3-54032924

**Emerson Network Power (Korea)**

8th Fl. Hongik University KangNamArt Center, 51-12 Banpo-Dong, Seocho-Gu, Seoul 137-044, Korea  
T: 82-2-34831500 F: 82-2-5927883

**Emerson Network Power (Malaysia) Sdn Bhd**  
Wisma Glomac 3, Block C, 6th Floor, Jalan SS 7/19, Kelana Jaya, 47301 Petaling Jaya, Selangor Darul Ehsan, Malaysia  
T: 603-7884 5000 F: 603-7884 5188

**Emerson Network Power (New Zealand)**  
Unit 2, 75 Blenheim Road, Christchurch New Zealand  
T: 64-3-3430235 F: 64-3-3430250

**Emerson Network Power (Philippines), Inc.**  
3/F, King's Court 1 Building, 2129 Chino Roces Avenue, Makati City 1200, Philippines  
T: 63-2-8934177 / 178 F: 63-2-8112027

**Emerson Network Power (Singapore) Pte Ltd**  
27 International Business Park #03-01 Primefield-Landmark Building Singapore 609924  
T: 65-64672211 F: 65-64670130

**Emerson Network Power (Taiwan) Ltd**  
11F, 141 Jen Ai Road, Section 3, Taipei 106, Taiwan, R.O.C.  
T: 886-2-87713655 F: 886-2-87717297

**Emerson Network Power (Thailand) Co Ltd**  
123 Suntowers Bldg.-B, 22nd Fl, Vibhavadi-Rangsit Road, Ladyao, Chatuchak, Bangkok 10900, Thailand  
T: 66-2-6178260 F: 66-2-6178277 / 278

**Countries covered by our Asia Network include:**

Bangladesh, Sri Lanka, Nepal, Pakistan, Vietnam, Laos, Seychelles, Cambodia, Brunei, Papua New Guinea, Fiji

Mail [marketing@emersonnetwork-ap.com](mailto:marketing@emersonnetwork-ap.com) for contact details

**Emerson Network Power.**

The global leader in enabling business-critical continuity.

[emersonnetworkpower.com](http://emersonnetworkpower.com)

-  **AC Power**
-  **Embedded Power**
-  **Outside Power**
-  **Connectivity**
-  **Inbound Power**
-  **Precision Cooling**
-  **DC Power**
-  **Integrated Cabinet Solutions**
-  **Site Monitoring and Services**

Emerson Network Power and the Emerson Network Power logo are trademarks and service marks of Emerson Electric Co. 2005 Emerson Electric Co.

AP05DPG15PHR1

