

PowerSure™ PSA

Quick-Start Guide for 350-1000VA; 120V

WHAT'S IN THE BOX

- Quick-Start guide
- PowerSure family user manual on CD (also at www.liebert.com)
- Warranty card
- MultiLink™ software CD
- MultiLink serial cable (M3LS9P9S), 10 ft. (3m)
- RJ-11 cord, 7 ft. (2.1 m)
- USB cable, 6 ft. (1.8m)

For more details, refer to the PowerSure user manual on CD.

Para una información más detallada, consulte el manual del usuario de la familia PowerSure en el CD.

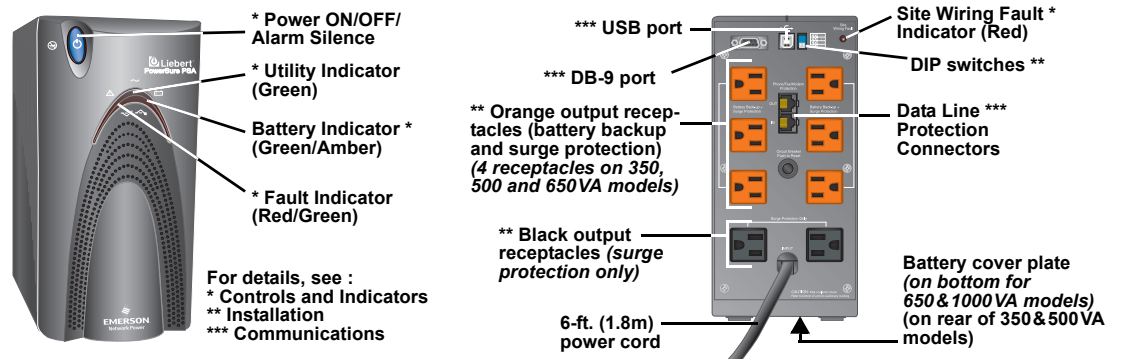

INSTALLATION

Read all safety, installation and operating instructions in the PowerSure family user manual on the included CD or at www.liebert.com before operating the UPS. Adhere to all warnings on the unit and in the manual.

1. Install the UPS indoors in a controlled environment, where it cannot be accidentally turned off. Place it in an area of unrestricted airflow around the unit, away from water, flammable liquids, gases, corrosives and conductive contaminants. Maintain a minimum clearance of 4 inches (100mm) on each side of the UPS. Maintain an ambient temperature range of 32°F to 104°F (0°C to 40°C).
2. Plug the PSA's power cord into an AC outlet. Check the Site Wiring Fault Indicator on the rear; if it is illuminated, refer to the **Troubleshooting** section.
3. Plug any computers and monitors into the orange receptacles for battery backup and surge protection; other office machines that do not exceed the capacity of the UPS may be plugged into either of the two (2) black receptacles, which provide surge protection only.
4. Connect Phone/Fax/DSL/Internet/Modem devices to data line connectors.
5. Press and release the ON/OFF/Alarm Silence button to turn on the UPS. The UPS will beep and the Utility Indicator will illuminate (green).
6. Turn on connected equipment.

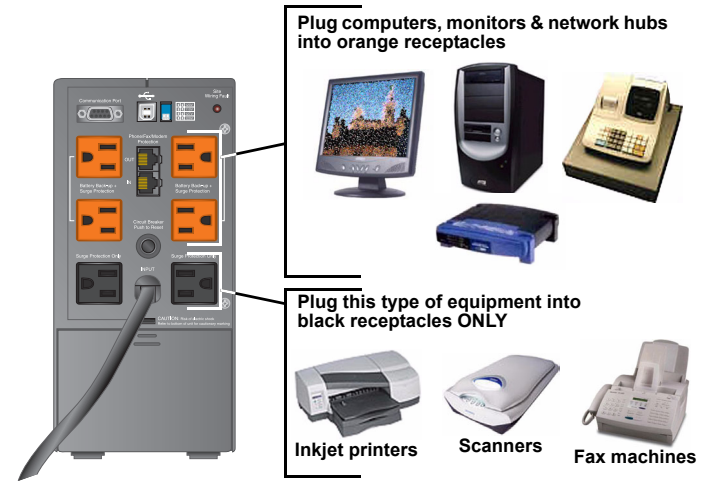

CONTROLS AND INDICATORS

- This button controls output power to the connected load and has three functions:
- Turns the PowerSure PSA ON
 - Turns the PowerSure PSA OFF
 - Silences PowerSure PSA alarms

TURN THE UPS ON: Press and release the main ON/OFF button to start the UPS. An audible alarm will sound briefly.

TURN THE UPS OFF: When the PSA is ON, hold the main ON/OFF button down for more than 2 seconds to shut it down. An audible alarm will sound briefly.

SILENCE AN ALARM: When a UPS alarm is active, press and release the main ON/OFF button to silence the audible alarm (Exceptions: low battery, overload and overtemperature). DO NOT hold the button down for more than 2 seconds or the PSA will shut down.

CHECK THE PSA'S CONDITION: Three status indicators on the front of the UPS illuminate to specify the status of the UPS (see **Troubleshooting** section for details).

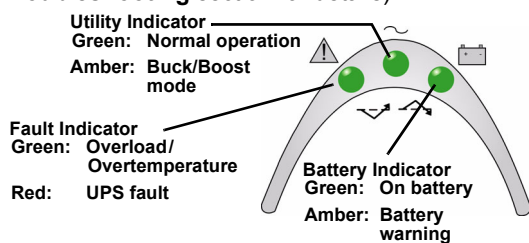

SITE WIRING FAULT INDICATOR (RED)

The Site Wiring Fault Indicator on the rear panel, as shown, illuminates red when the UPS detects a line-neutral reversal or a poor neutral-ground. (See **Troubleshooting Chart** if indicator is illuminated.)

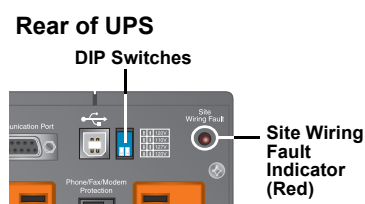

TRANSFER VOLTAGE SELECTORS (DIP SWITCHES)

The two-position DIP switch control on the rear panel, shown above, allows the operator to select the utility transfer voltage at which the UPS will switch to battery power. The factory default settings are 100VAC - 135VAC. DIP switch positions for each voltage setting are:

DIP switch settings			
Left	Right	Nominal Utility	Setting
↑ Up	↑ Up	120VAC	85 - 145VAC (default)
↑ Up	↓ Down	110VAC	78 - 138VAC
↓ Down	↑ Up	127VAC	90 - 150VAC
↓ Down	↓ Down	120VAC	85 - 145VAC

CAUTION Never change the voltage settings while the UPS is ON and powering connected loads. Change DIP switches only when the UPS is OFF.

CAUTION To ensure protection of the connected equipment, the DIP switch settings should match the nominal utility input voltage. DIP switch settings not matching the nominal utility could potentially damage connected equipment.

COMMUNICATIONS

The PowerSure PSA will communicate with your computer in either of two ways: over its DB-9 port through Liebert's MultiLink™ software or by USB through Microsoft® Windows® operating system features.

MultiLink supplies useful monitoring data, such as input voltage and battery level, and will perform an orderly shutdown of the computer system. Microsoft Windows XP and 2000 operating system utilities supply UPS status information and will perform an orderly computer shutdown. Check your computer's OS features to determine whether it has power management capability.

For MultiLink Serial Communications

- Connect the provided MultiLink serial cable to the DB-9 ports on the rear of the UPS and on the rear of your computer.
- Install the MultiLink software—the software, installation instructions and the user manual are on the CD included in the PowerSure PSA package.

For USB Communications (with operating system power management)

- Connect the USB cable provided with the UPS to the USB ports on the PSA and your computer. The PSA will work automatically with the built-in power management software on Windows XP and 2000 or later.
- All USB models are compatible with Microsoft Windows 2000, Windows XP and Macintosh® OS 10.2 or later.

SPECIFICATIONS

Model Number	PSA350MT-120	PSA500MT-120	PSA650MT-120	PSA1000MT-120
Power Rating VA/W	350VA/210W	500VA/300W	650VA/390W	1000VA/600W
DIMENSIONS: in. (mm)				
Unit WxDxH	4.6x7.7x8.7 (116x196x222)	4.6x7.7x8.7 (116x196x222)	4.6x14.1x8.7 (116x358x222)	4.6x14.1x8.7 (116x358x222)
Shipping WxDxH	7.7x12.2x11.5 (196x310x293)	7.7x12.2x11.5 (196x310x293)	9.5x19.7x12.4 (242x500x316)	9.5x19.7x12.4 (242x500x316)
WEIGHT: lbs (kg)				
Unit	16.8 (7.6)	17.2 (7.8)	20.7 (9.4)	29.7 (13.5)
Shipping	18.1 (8.2)	18.5 (8.4)	22.9 (10.4)	31.9 (14.5)
INPUT AC PARAMETERS				
Surge Protection	570J			
Voltage Range Without Battery Operation	78VAC - 150VAC, DIP switch selectable (see "DIP switch settings" on page 1)			
Frequency Range	46.5 - 63.5 Hz (±0.1 Hz)			
Input Power Cord	6 ft. (1.8m) attached, w/ NEMA 5-15 P			
OUTPUT AC PARAMETERS				
Output Receptacles	(4) NEMA 5-15R (orange) Battery backup + surge protection; (2) NEMA 5-15R (black) Surge protection		(6) NEMA 5-15R (orange) Battery backup + surge protection; (2) NEMA 5-15R (black) Surge protection	
Voltage (Normal mode)	Nominal (110, 120, 127VAC) ±10%			
Voltage (Battery mode)	120VAC ±8%			
Output Current	2.9 A	4.2 A	5.4 A	8.3 A
Waveform (Battery mode)	Stepped Sinewave			
Frequency	50 Hz or 60 Hz; auto sensing			
Overload Warning (Normal & Battery modes)	>100%			
Overload Shutdown	>110%			
BATTERY PARAMETERS				
Type	Valve-regulated, nonspillable, lead acid			
QuantityxVoltageXRating	(1)x12Vx7Ah	(1)x12Vx9Ah	(1)x12Vx9Ah	(2)x12Vx7.5Ah
Transfer Time	4 - 6 ms typical			
Backup Time:	At 77°F (25°C), resistive loading, with fully charged batteries:			
Full Load	8 minutes	8 minutes	5 minutes	5 minutes
Half Load	26 minutes	24 minutes	16 minutes	18 minutes
Recharge Time	6 hours to 90% of rated capacity, after full discharge into resistive load			

ENVIRONMENTAL (ALL MODELS)	
Operating Temperature	+32°F to +104°F (0°C to +40°C)
Storage Temperature	+5°F to +104°F (-15°C to +40°C)
Relative Humidity	0% to 95%, non-condensing
Operating Elevation	Up to 10,000 ft. (3000m) at 86°F (30°C) without derating
Audible Noise	< 40 dBA, at 1 meter
AGENCY	
Safety	UL 1778, c-UL Listed
Surge	ANSI C62.41, Category A, Level 3 (IEEE 587, Category A); EN61000-4-5, Level 3, Criteria A
ESD	EN61000-4-2, Level 3, Criteria A
Susceptibility	EN61000-4-3, Level 3, Criteria A
Electrical Fast Transient/Burst	EN61000-4-4, Level 4, Criteria A
Emissions	FCC Part 15, Subpart B, Class B
Conducted Immunity	EN61000-4-6, Level 3, Criteria A
Harmonics	EN61000-3-2
Flicker	EN61000-3-3
Transportation	ISTA Procedure 1A

TROUBLESHOOTING

The information below indicates various symptoms a user may encounter in the event the PowerSure PSA experiences a problem.

Use this information to determine whether external factors caused the problem. See **Troubleshooting Chart** for suggested remedy.

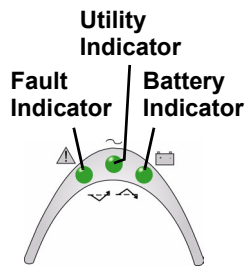

1. The Fault indicator illuminates, indicating the UPS detected a problem.
2. An alarm sounds, alerting that the UPS requires attention. The alarm can be silenced except for low battery, overload and overtemperature warning conditions.
3. Utility and/or Battery indicators may be illuminated as a diagnostic aid to the operator, as shown below:

GUIDE TO STATUS INDICATORS

Fault Indicator	Utility Indicator	Battery Indicator	Diagnosis/Audible Alarm
—		—	Normal operation with utility power present; no beep.
—	—		UPS is operating on battery; beep every 10 seconds.
—	—		Battery test has been initiated; no beep.
—			Battery needs to be replaced; long beep every minute.
—	—		Low battery warning; beep every half-second.
		—	Overload warning, load is >100%; beep every half-second.
	—	—	Overload shutdown, load exceeds UPS capacity (110%); continuous beep.
		—	Overtemperature (overtemp) warning; beep every 5 seconds (Normal mode).
	—		Overtemperature (overtemp) warning; beep every 5 seconds (Battery mode).
	—	—	Overtemperature (overtemp) shutdown; long beep every 5 seconds.
		—	UPS is on, fault warning; continuous beep.
	—	—	UPS has failed & shut down; continuous beep.

TROUBLESHOOTING CHART

If the UPS fails to operate properly, turn off the unit and repeat the steps in the **Installation** section of this manual. If the problem persists, refer to the chart below:

Problem	Cause	Solution
UPS will not start	Overload/Short Circuit	Check the circuit protector on the rear of the UPS. If it is tripped, reset it and restart the UPS. For further help, call your local dealer, Liebert representative or the Liebert Worldwide Support Group.
	Battery disconnected or is completely discharged	Check for proper connection of battery or batteries.
UPS starts on battery, but will not switch to AC	UPS not plugged in	Plug in the power cord securely.
	Circuit protector tripped	Reset the circuit protector and restart the UPS.
	Power not available at utility receptacle	Have the utility checked by a qualified electrician.
	Input voltage below threshold	Wait until the voltage rises to an appropriate level or have the utility checked by a qualified electrician.
UPS shuts down, Fault Indicator lit	Overload/Short Circuit	Check the circuit protector on the rear of the UPS. If it is tripped, reset it and restart the UPS. If the problem persists, disconnect some of the equipment from your UPS—the total wattage of your equipment must not exceed the capacity of the UPS. For further help, call your local dealer, Liebert representative or the Liebert Worldwide Support Group.
	Internal UPS fault	Wait until voltage lowers to an appropriate level or have the utility checked by a qualified electrician.
	High temp shutdown	Make sure that the UPS is operating in 32°F to 104°F (0°C to 40°C) and that it has adequate ventilation.
	MultiLink shutdown	Consult the MultiLink user manual or contact your LAN administrator.
Site Wiring Fault Indicator illuminated	Line-neutral reversal, Poor ground connection	Have the utility checked by a qualified electrician.
UPS not providing expected back-up time	Overload	Reduce load.
	Battery not charged due to a recent outage	Recharge battery.
	Battery needs to be replaced	Replace battery.

MAINTENANCE

The PowerSure PSA UPS requires very little maintenance. Follow these practices to prevent problems.

CLEANING THE UPS

The following will help ensure trouble-free operation for years:

- Vacuum dust from the ventilation intake occasionally.
- Wipe the cover periodically with a dry cloth.

MAINTAINING BATTERIES

The batteries are valve-regulated, nonspillable, lead acid and must be kept charged to retain their design life. The UPS continuously charges the batteries when connected to the utility supply, even while the UPS is switched off.

When storing the UPS, it is recommended to plug in the UPS for at least 24 hours every four to six months to ensure full recharge of the batteries.

BATTERY REPLACEMENT



CAUTION

A battery can present a risk of electrical shock and high short circuit current. The following precautions should be observed before replacing the batteries:

- Remove rings, watches, and other metal objects.
- Do not lay tools or other metal objects on top of the batteries.
- If the battery replacement kit is damaged in any way or shows signs of leakage, contact your local dealer or Liebert representative immediately.
- Do not dispose of batteries in a fire. The batteries may explode.
- Dispose of old batteries according to local codes.

This UPS is equipped with internal “hot swappable” batteries that the user can replace without shutting down the UPS or connected loads.



NOTE

Caution should be exercised when replacing the batteries because the load is unprotected from disturbances and power outages during this procedure.

PRODUCT WARRANTY REGISTRATION

To register for warranty protection:

- Visit the **Quick Links** section of our Web site at: <http://www.liebert.com>
- Click on **Product Warranty Registration** and fill in the form.

If you have any questions, please contact us at:

US: 800-222-5877
Outside the US: 614-841-6755
upstech@liebert.com

BATTERY REPLACEMENT

Replacement requires removing the battery cover plate on the bottom of the UPS. No tools are needed.

To replace the batteries:

1. Remove the battery cover plate on the back/bottom of the UPS (**Figure 1**).
2. Pull the white tabs towards you to remove the battery from the UPS (**Figure 2**).

Figure 1



Figure 2

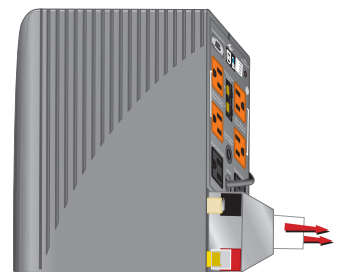

3. Disconnect the insulated connectors from the battery terminals (**Figure 3**).
4. Insert a new battery pack, and push the connectors onto the battery terminals (black to black & red to red) (**Figure 4**).

Figure 3

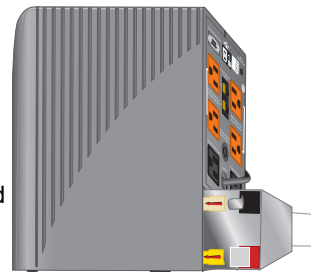
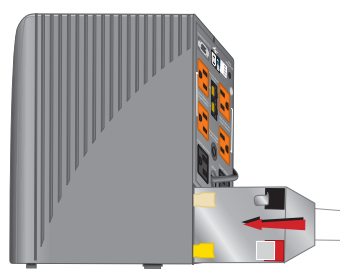

Figure 4



NOTE: There may be a small spark at the battery terminals when reconnecting the connectors. This is normal and will not harm you or the UPS.

5. Push the battery pack into the UPS (**Figure 5**).
6. Reattach the battery cover plate (**Figure 6**).

Figure 5

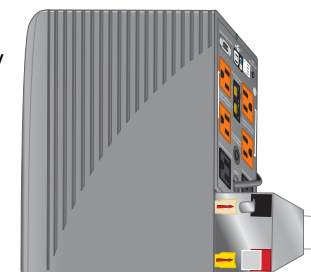

Figure 6

