

■ AC Power
For Business-Critical Continuity™

Liebert® Power Solutions

IT System Protection That Grows With Your Needs



A Comprehensive Power Solution—We're The Only One Who Has It

The Widest Range Of Products Gives You An Infinite Range Of Solutions

It All Starts With Rack Systems

Liebert and Knurr brand computer rack systems offer all the advanced features and innovative flexibility required to accommodate today's dense and complex IT systems and network gear.

Knurr racks simplify equipment installation, improve cable management and increase visibility and control of equipment inside the rack.

Liebert enclosures integrate power and cooling to provide a complete rack-based support system. Liebert pioneered this approach with the Little Glass House and today provides enclosures, such as the Liebert MCR and Liebert XDF, which protect sensitive electronics in almost any environment.

UPS Systems

Emerson Network Power offers Liebert brand UPS in all three major uninterruptible power supply (UPS) system configurations:

- **Stand-by UPS**—Passes utility power straight through to the protected load with a 2-6 ms break in power when transferring to battery back-up.
- **Line-Interactive UPS**—Provides power conditioning with a 2-6 ms break in power when transferring to battery back-up.
- **On-Line (Double Conversion) UPS**—Delivers continuous, high-quality AC power to equipment with no break when transferring to battery. Protects equipment from virtually all power disturbances due to blackouts, brownouts, sags, surges or noise interference.

Emerson Network Power offers UPS systems in the industry's widest range of sizes including desktop, rack-mount and enterprise systems for full facility power.

Critical Electrical Distribution

Emerson Network Power offers a range of power distribution systems designed to efficiently deliver conditioned power to your critical equipment. These products include high-reliability distribution systems, starting with rack power distribution systems, specially designed for computer and communications applications, as well as transfer switches offering ultra-fast transfer between two independent AC power sources to provide virtually uninterrupted power to sensitive electronic equipment.

Power Quality Protection

For applications requiring protection from electrical line disturbances without the need for back-up capability, Emerson manufactures a full line of power conditioning equipment. It includes a wide variety of transient voltage surge suppression (TVSS) solutions ranging from high-quality surge suppressors for use with PCs, workstations and other peripherals to facility-wide systems with sophisticated active tracking capability.

DC Power Systems For Communications Applications

From major switching centers to remote shelters, Emerson DC power systems offer performance and features to match virtually every telecommunications equipment application. The line includes a variety of system capacities ranging from small systems at less than 3 kW up to large systems rated at over 60 kW. The product offering also includes distribution bays, enclosures and network management products such as controllers, monitors and supervisory software to control and maintain energy equipment in a telecommunications network.

Power System Monitoring

Liebert brand power communications software and hardware provides multiple levels of monitoring and control. Capabilities range from automated shutdown software to facility-wide centralized systems that provide a full range of monitoring, control and analysis.

There Is A Liebert Power Solution To Meet Every Need

CONTENTS

		Computer Rooms	Data Centers	Network Closets	Production	Labs & Testing	Telecom / CATV	Emergency Shelters	Desktops / Peripherals	Point-Of-Sale
1	Racks, Integrated Cabinets, Modular Power Distribution									
10	Knurr Rack Enclosure System	■	■	■	■	■	■	■		■
11	Liebert MCR Mini Computer Room Enclosure	■	■	■	■	■	■	■		■
12-13	Smart Solutions	■	■	■	■	■	■	■		■
14-15	Liebert MB Modular Busway	■	■	■	■	■	■	■		■
2	Rack PDU									
16	Liebert MPX Adaptive Rack PDU	■	■	■	■	■	■	■		■
17	Liebert MPH Managed Rack PDU	■	■	■	■	■	■	■		■
18	Liebert MPX And Liebert MPH	■	■	■	■	■	■	■		■
19	Knurr DI-STRIP, Basic Rack PDU	■	■	■	■	■	■	■		■
3	Desktop UPS For One-On-One Applications									
20	Liebert PSP Stand-by UPS: 350-650 VA								■	■
21	Liebert PSA Line-Interactive UPS 500 – 1500 VA								■	■
4	Rack-Mount UPS For Distributed Network Applications									
22-23	Liebert PSI And PSI-XR Line-interactive UPS: 750-3000 VA			■		■			■	■
24	Liebert GXT3 On-line UPS: 500-3000 VA			■	■	■	■	■	■	■
25	Liebert GXT3 On-line UPS: 5 - 10 kVA			■	■	■	■	■		■
5	Enterprise UPS For Computer Room And Data Center Applications									
26	Liebert Nfinity On-line UPS: 4-20 kVA	■		■	■	■	■	■		■
27	Liebert NX On-line UPS: 10-30 kVA	■			■	■	■	■		■
28-29	Liebert NX On-line UPS: 40-200 kVA	■	■		■	■	■	■		■
30-31	Liebert APM On-line UPS: 15-90 kVA	■	■		■	■	■			
32-33	Liebert Npower On-line UPS: 30-130 kVA	■	■		■	■	■	■		■
34-35	Liebert NXL On-Line UPS: 250-750 kVA	■	■		■	■	■	■		■
36-37	Liebert Series 610 On-line UPS: 225-1000 kVA	■	■		■	■	■	■		■
38-39	Liebert Trinergy On-line UPS: 400kVA - 3.2MVA	■	■		■	■	■			■
6	Power Distribution Systems For Critical Protection Applications									
40	Liebert FDC Power Distribution Cabinet	■	■		■		■			
41	Liebert RDC Remote Distribution Cabinet (RDC)	■	■		■		■			
42	Liebert FPC Power Conditioning & Distribution Cabinet	■	■				■			
43	Liebert PPC Conditioning And Distribution Cabinet	■	■				■			
44	Liebert STS2 Static Transfer Switch2 (STS2)	■	■				■	■		
45	Liebert STS2/PDU Static Transfer Switch/Power Distribution Unit	■	■				■			
46-47	Liebert Power Systems Test Center	■	■				■			
7	Surge Protection And Power Conditioning Systems									
48-49	High Exposure Systems, Low & Medium Exposure Systems, Home & Office Protection, and Data/Signal Line Protection	■	■	■	■	■	■	■	■	■
8	DC Power Systems For Telecommunications Applications									
50-51	Small Power, Medium Power, Large Power, Inverter Systems, Batteries & Accessories	■	■	■	■	■	■	■		■
9	Monitoring And Control									
52-53	Liebert IntelliSlot, Liebert Nform & Liebert SiteScan Web	■	■	■	■	■	■	■		
54-55	Liebert Services	■	■	■	■	■	■	■		

Trouble Is Coming Down The Power Line And You Must Be Prepared

Every operation in your business depends upon the instant, around-the-clock availability of computers, servers and other electronic systems. If they aren't working, neither is your company.

Unfortunately, every piece of this equipment your company possesses is subject to the whims of the electricity that powers it.

The first step in taking control of this situation is to understand the threats to your system reliability—and exactly what you can do about them.

*You Face Many **Challenges** In The Pursuit Of Productivity*

Is There Really A Problem?

"My computer can ride right through a short blip in the power—why do I need anything else?"

Different Needs Require Different Power Protection Configurations

"Should I have a small UPS for each workstation or have everything on one large system. Which is best for my facility?"

A Lot Can Happen Between Your UPS And The Equipment It Is Protecting

"We have dozens of pieces of networking equipment. How can I make sure that each one is getting exactly the power it needs?"

Every Wire Carries The Potential For Trouble

"An electrical surge came in through an outside phone line and knocked out our entire communications system. Is this going to happen again?"

A Single Source Of Power Simply May Not Be Enough

"Adding a second power feed would certainly enhance our availability picture—but who can we talk to about getting it done right?"

You Need Efficiency... Without Compromising Availability

"Budgets are tight, so I have to consider equipment costs at all lifecycle phases — first cost, operation, and service. How do I maximize efficiency and ensure reliability?"



But There Are Real Solutions

You Need Protection From All Power Problems

An outage is just the problem you can see. There are many other more frequent power fluctuations—surges, spikes, sags—that you don't see. These are the conditions that cause the “unexplained” lock-ups and other potentially damaging results. Protecting critical network and computing systems requires the expertise of someone who understands all the risks you face from poor power quality.

Centralized Vs. Distributed UPS Protection

Liebert has the breadth of products that allows you to implement either a centralized or a one-on-one distributed power protection strategy depending on your requirements. Whatever configuration you choose, you can count on Liebert to make it the best it can be. Benefits, such as increased system security, more efficient maintenance and improved reliability, may make a centralized strategy a better choice for larger operations.

Proper Power Depends On Proper Distribution

In network applications, there may be hundreds of different loads with various voltage requirements, a mix of AC and DC power, plus any number of other electrical specifications. This calls for a distribution system that is designed to maintain the highest levels of reliability and quality between the source of conditioned power and the protected equipment.

Power Conditioning And Surge Protection Throughout The Facility

Power conditioning and surge suppression systems are key to maintaining power quality in critical facilities. Raw utility power is often far too “dirty” for sensitive systems, resulting in lost or garbled data, unexpected software glitches or shutdowns, even hardware damage. The IEEE recommended practice is to install transient voltage surge suppression (TVSS) protection on every electrical conductor that penetrates a facility shell, including power lines, telephone and other communications links.

Maximum Reliability Demands Dual Power Sources

If your needs require the highest level of system availability, Liebert has the knowledge and products to implement a dual-power strategy throughout your enterprise. UPS, transfer switching, power distribution and other equipment are all brought together to create the ultimate in reliability.

Optimize Data Center Infrastructure With Efficient, High Availability Technologies

Emerson Network Power delivers *Efficiency Without Compromise*[®] — technologies and products that optimize data center infrastructure to reduce design, management and energy costs while maintaining high availability and flexibility. Our industry-leading technologies optimize efficiencies and reliability in identified areas of opportunity: Infrastructure Management; Eco Availability; Flex Capacity; and High Density.

Where Do You Need Mission-Critical Power Protection Technology?



We have efficient, high availability power solutions for any of the applications that are part of your mission-critical business operations.

Liebert has identified ten distinct zones or areas of application, found within many business operations, which have a requirement for mission-critical power technology. While these zones have similarities in the importance of their essential functions, they also have different needs for infrastructure protection—all of which can be met by Liebert solutions.

Large Data Centers—High availability data and network applications are the heart of your enterprise with blade servers and high-density racks that demand increased power protection.

Small To Mid-Size Data Centers—Smaller sized network and computer facilities, but equally essential to your operations.

Network Closets—Housing routers, switches, modems, cabling devices and numerous other communications components.

Network Operations Centers—As networks expand and grow more complex, you need reliable and timely access to mission-critical infrastructure monitoring information long before problems arise.

Production—Smart factories backed by a complex electronic network, from computer-controlled machinery and processes to electronic sensors, business systems and utility equipment.

Laboratories and Testing—Sensitive computers and equipment used for diagnosing patients, analyzing data, performing critical tests, and operating electronic tools and lab instruments.

Telecom/CATV—Anything from indoor and outdoor spaces hosting cable, DSL and fiber optics to remote cell sites and enclosures.

Emergency Shelters—Emergency operations centers, 911 response emergency dispatch, police and fire facilities, medical facilities, public works operations and more.

Desktop/Peripherals—Home and small office computers, modems, network components and other electronic equipment that is vital to business operations.

Point-of-Sale—Today's cash registers and store-level computer networks not only handle sales transactions, they also collect and transmit vital customer and inventory data required to make informed supply chain decisions.

Telecom Wireline/Wireless Sites

Liebert can provide a reliable flow of both AC and DC power for telephone switching systems and other communications equipment.

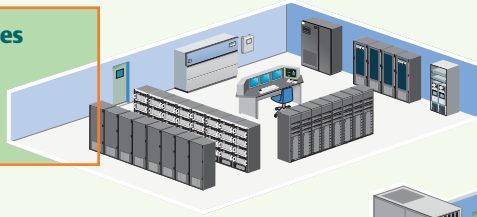

Emergency Shelters

High-reliability Liebert UPS systems and DC power equipment are critical to maintaining operations in telecommunications shelters and other unmanned structures.

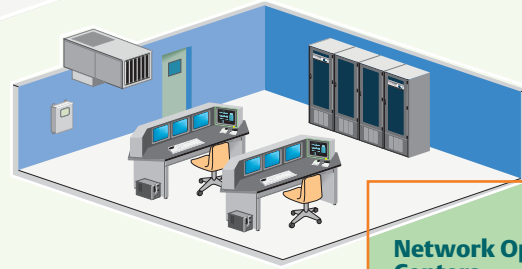
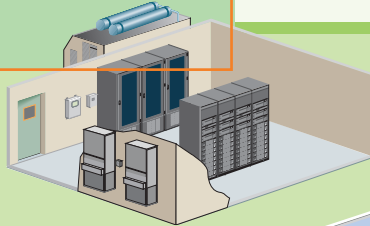

Network Operations Centers

With many mission-critical computing systems located right in the office space, there is a need for UPS protection that can be placed nearby. Liebert offers a number of power systems that are especially designed for use in business and office environments.

Network Closets

These densely-packed equipment bays, housing servers or other essential communications devices require UPS back-up plus distribution to get uninterrupted, conditioned power to each and every component in the rack.

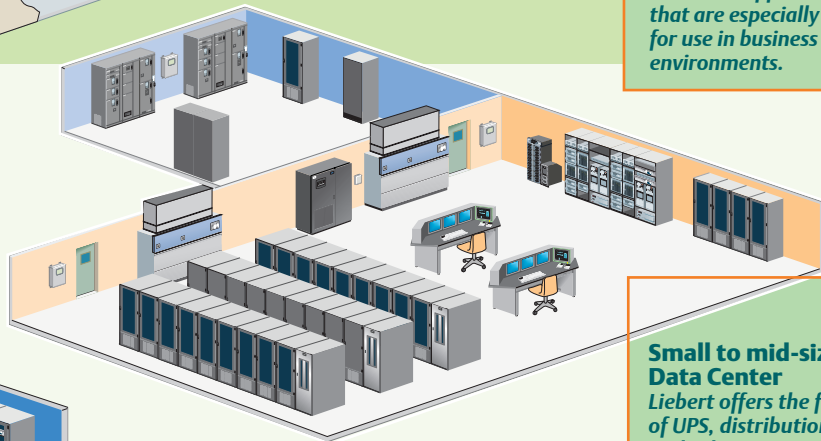
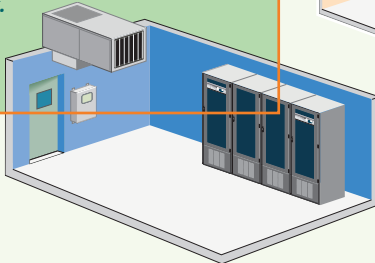

Small to mid-size Data Center

Liebert offers the full range of UPS, distribution systems and other power protection equipment that can adapt to data center growth requirements.

Data Center

Liebert offers the full range of UPS, distribution systems and other power protection equipment to meet the needs of the largest data centers and networking facilities.

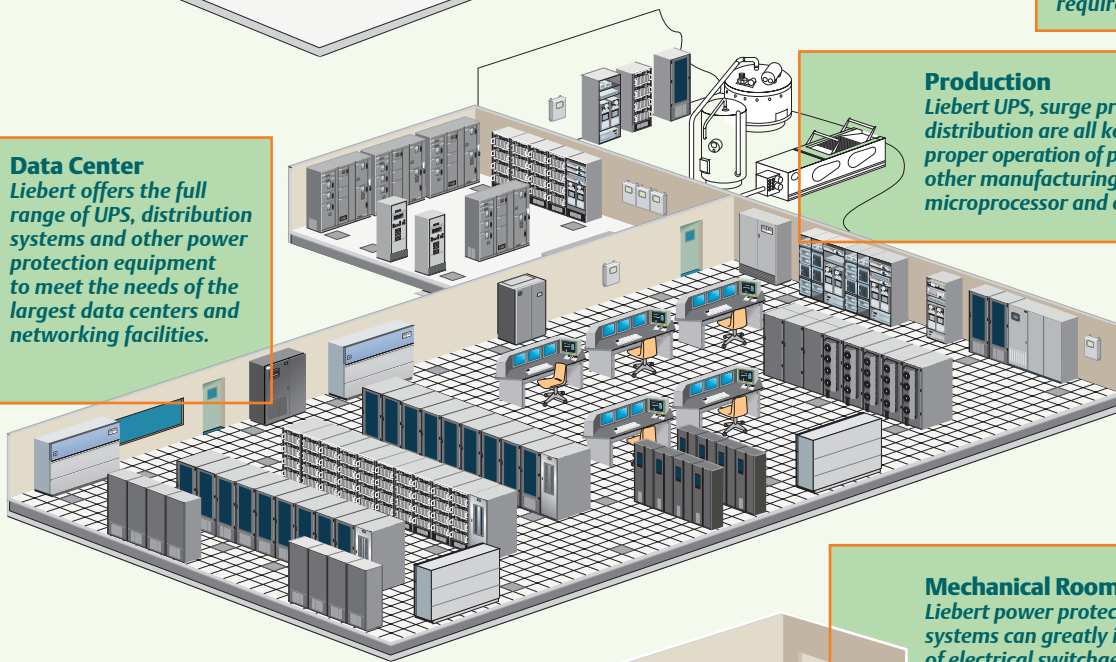

Production

Liebert UPS, surge protection and power distribution are all key to maintaining the proper operation of process control and other manufacturing systems that utilize microprocessor and computer control.

Mechanical Rooms

Liebert power protection and conditioning systems can greatly improve the operation of electrical switchgear and motor control centers vital to numerous functions throughout an industrial facility.

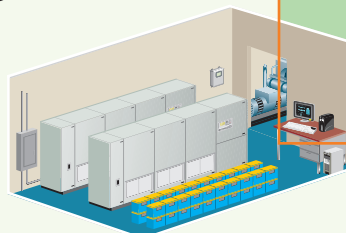

Efficiency Without Compromise®

Design, Operation, Management And Planning
Optimized For Efficiency And High Availability.

Areas of Opportunity

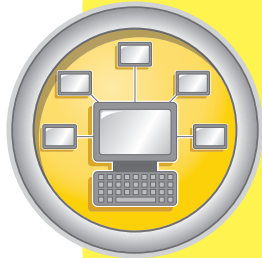

INFRASTRUCTURE MANAGEMENT

Improving performance of the IT infrastructure and environment

Expert Advice

- Critical infrastructure expertise enables highly efficient and effective designs.
- Assessments identify power and cooling improvements that provide immediate and ongoing cost savings.



ECO AVAILABILITY

Balancing high levels of availability and efficiency

Uninterruptible Power

- Liebert NX and Liebert NXL deliver highly reliable on-line UPS protection while providing efficiencies of up to 94% at part load and up to 97% at full load. When operating on Eco-Mode, the always-on inverter ensures high availability and seamlessly assumes the load in case of a utility power disturbance.



FLEX CAPACITY

Adapting to IT changes for continuous optimization and design flexibility

Variable Air Flow

- Liebert CW with VSD reduces energy consumption by 50% at 80% speed, saving up to \$5,000/year/unit and providing a <2 year payback.
- Liebert CW with EC Fans reduces energy consumption by up to 30% at full speed and 65% at 80% speed.

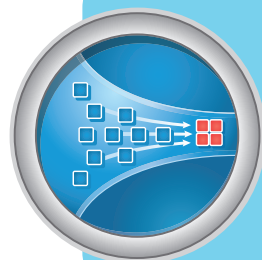

HIGH DENSITY

Delivering architectures from 10-60 kW/Rack to minimize space and cost

High Density Cooling

- Liebert XD can cool densities of >30 kW/Rack and is up to 30% more efficient than traditional cooling systems.
- Liebert XD uses pumped refrigerant and dewpoint control to prevent condensation.



Management Tools & Technologies

- IT, rack, row and room sensor networks provide management and control of temp, humidity, pressure, power, water detection, capacity, and battery health.
- Centralized real-time monitoring reduces downtime and management.

Integration & Operation Services

- Implementation and commissioning services ensure rapid deployment.
- Enterprise remote monitoring enables proactive management.
- Standards-based interface with Building Management System bridges IT and facility management.

Economization

- Fluid economizers enable “free cooling” while controlling temperature, humidity, and preventing contamination.
- Liebert Glycool safely uses outside temperatures to reduce cooling system compressor runtime, saving up to 25% of energy cost.

Critical Services

- Preventive maintenance optimizes the lifetime value of equipment.
- Facility Power Audits maximize efficiency and availability.
- Battery monitoring and service maximizes performance, life, and availability.

Variable Capacity

- Liebert DS is the only data center cooling system to use variable capacity Digital Scroll compressors.
- Variable capacity compressors reduce energy consumption by up to 30% on an air cooled system, saving up to \$5,000/yr/unit.

Intelligent Control

- Liebert iCOM with predictive control and teamwork saves up to 7% energy consumption over traditional controls.
- Manages “zones” including non-homogeneous heat loads, contained areas, and localized high density areas for optimized cooling performance.

Intelligent Aisle Containment

- SmartAisle by Emerson Network Power eliminates temperature stratification and excess airflow at IT equipment source.
- Easily retrofitted with existing cooling infrastructure for up to 30% efficiency and up to 25% capacity improvements.

Power Architecture

- Liebert and Knurr rack PDUs are available in configurations up to 60 amp, with an industry-leading standard operating temperature of up to 131°F, for reliable support of high density racks.
- Standard TP-1 transformers in PDUs provide up to 98.7% efficiency.

With more ways to optimize data center infrastructure to reduce design, management and energy costs while maintaining high availability and flexibility, Emerson Network Power delivers...

Efficiency Without Compromise

Knurr Racks And Cabinets

The Right Place To Protect Network Equipment

The Knurr DCM enclosure is a new platform from Emerson Network Power that lets facility managers and IT professionals manage server, switch, and termination applications.

Knurr DCM was designed as the base element for all of Emerson Network Power's row and rack solutions and is compatible with all Liebert Power and Liebert Precision Cooling products. The Knurr DCM offers all the advanced features and innovative flexibility required to accommodate today's dense and complex IT systems and network gear.

Knurr DCM simplifies equipment installation, improves cable management, and increases visibility and control of equipment inside the rack. The rack easily integrates power, cooling, and monitoring systems to provide a complete support system.

Knurr Racks Are Ideally Suited For:

- Data centers.
- Network closets.
- Telecommunication equipment.

Ready-To-Deploy Rack And Enclosure Solutions.

Knurr DCM racks provide the convenience of robust 19" racks with high-end features and standardized options to provide fast customization for individual site needs. The racks are designed for optimized air flow and maximized useful mounting space.

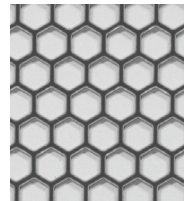

83% Open Area
For Improved Airflow, Highest In The Industry



Roof Pre-Drilled For XDV
Accepts XDV With No Need For Drilling



Spring Nut In T-Slot
Allows Component Mounting Anywhere In Cabinet Frame



Tool-Less Shelf
Mounts In Square Holes On 19" Rails In Seconds



Tool-Less Cable Management on Frame
Insert And 1/4 Turn, Installs In A Second



Doors Open to 135°
Allows Easy Access To Cabinet, Without Removing The Door

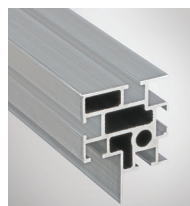

Lightweight Aluminum Frame
Makes The Cabinet Easier For A Single Person To Move

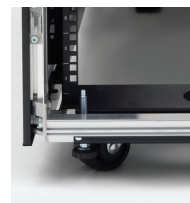

Low Profile Casters
Allows 42U Cabinet To Roll Through Standard Doorway

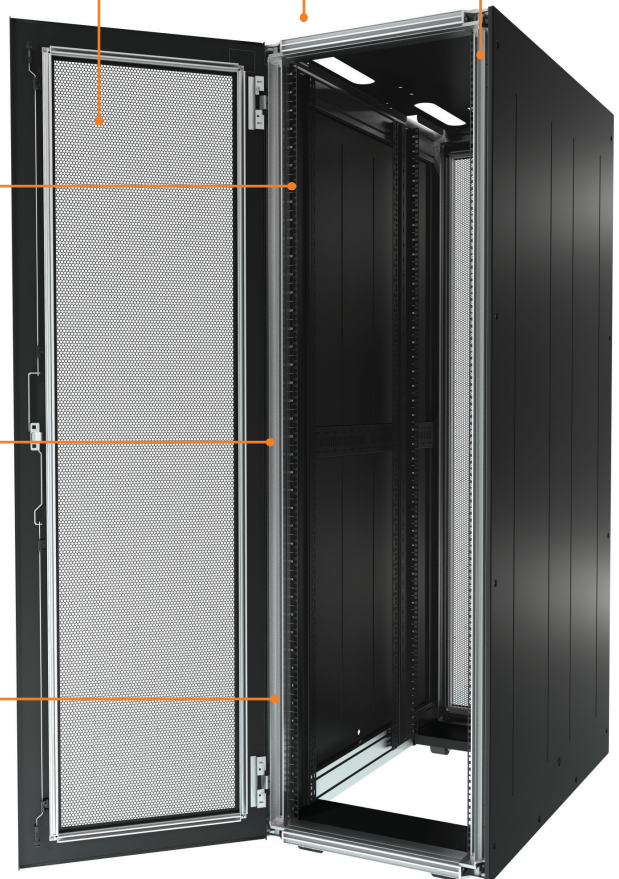

Liebert MCR Mini Computer Room Enclosure

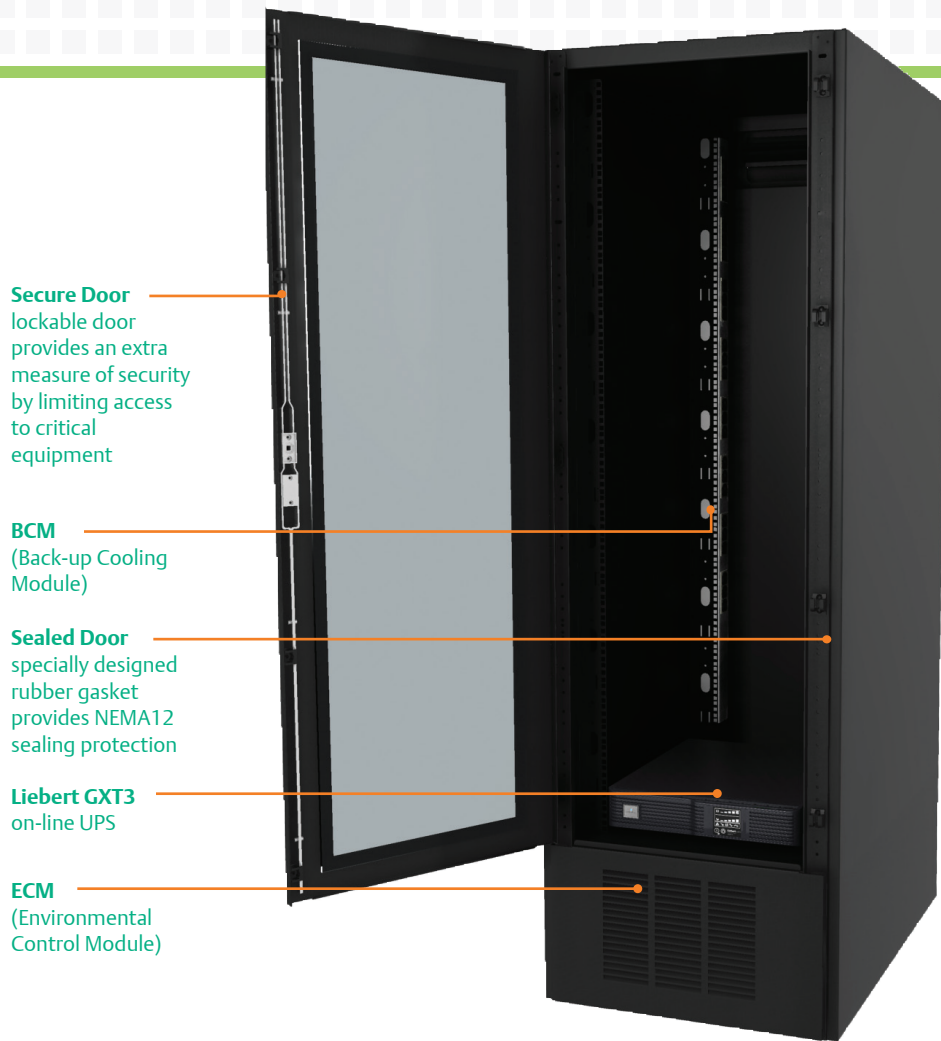

Secure Door
lockable door provides an extra measure of security by limiting access to critical equipment

BCM
(Back-up Cooling Module)

Sealed Door
specially designed rubber gasket provides NEMA12 sealing protection

Liebert GXT3
on-line UPS

ECM
(Environmental Control Module)

Liebert IP Telephony Availability System

Protecting The Edge Of The Network

Liebert has brought together several of our product solutions to create the IP Telephony Availability System. Especially designed to protect switches, routers and other critical components, this solution is ideal for use in remote locations such as branch offices, retail stores and other edge of the network applications. Housed in a Liebert Foundation™ wall mount enclosure or freestanding enclosure.

The Liebert IP Telephony Availability System, version 1.0, has met the Cisco Technology Developer Partner Program test criteria for interoperability with Cisco CallManager Express 3.1, Cisco Unity Express, release 1.1.2, Cisco Unity 4.0 (3), and Unity Bridge 3.0 (2).

True On-Line Power Protection



The Liebert GXT3, a true double conversion UPS, delivers the high level power quality required to fully protect critical network switching components from all power problems. Available in sizes from 500 up to 3000 VA.

Continuous Power Availability



In most cases, your critical routers and other network components cannot be without power even for scheduled UPS maintenance. To meet this need, the Liebert 2U Power Output Distribution (POD) system ensures continuous uptime by providing maintenance bypass capability as well as power output distribution.

Power System Monitoring, Communications & Remote Control



The Liebert Webcard, housed within the UPS, will deliver SNMP and web-management communications capabilities to your power system, including the ability to remotely reboot the switch by cycling the UPS power off and on.

Bundled UPS
systems available



Dual-Split Rear Door
available

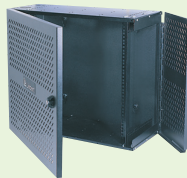

Wall Mount Systems 12 U
Hinge Body "swing out" and 12" depth
Low Profile available.



Liebert MCR Enclosure
For smaller spaces requiring the complete power and cooling protection.

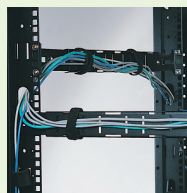

EX Cable Management Channel
This versatile option helps to enhance cabling organization and internal airflow.



Internal Power Distribution
A wide range of installed power strips is available to better accommodate power distribution needs within the enclosure.

Smart Solutions Deliver Efficiency, Capacity, Availability, Control

To help you achieve efficiency in all aspects of your data center, Emerson Network Power has developed the Smart Solutions intelligent, integrated infrastructure for data centers. The family uses a global design approach that can be localized for specific geographies.

Smart Solutions let you cost-effectively achieve and manage your objectives for efficiency, capacity and availability. These offerings provide fast and easy implementation, through interoperable systems: precision cooling, UPS, power distribution/conditioning, management software and racks.

No other solution offers the industry's leading power, precision cooling and data center infrastructure management systems for such a wide array of applications and environments.

Smart Solutions are fast and easy to implement, and are supported by local data center design experts and service professionals. Smart Solutions are typically more affordable than conventional data center designs – and they are more energy efficient.

Each Smart Solution offering integrates industry best practices in data center design and operations including:

- Hot air and cold air separation
- Cold air containment
- High availability and high efficiency UPS
- High-efficiency precision cooling
- Space-savings, small-footprint
- Modularity for flexibility and easier expansion
- Integrated monitoring and control to optimize efficiency in planning and management
- Unique local service for design audits, configuration support, installation support, maintenance and repair

Emerson Network Power brings together the industry's finest power, precision cooling, monitoring and management brands and businesses, including Liebert, Knurr, ASCO, Avocent, Chloride, Energy Systems and Surge Protection solutions. The Smart Solutions offerings deliver Efficiency Without Compromise™ within the data center.

Smart Solutions give you the efficiency, economy, interoperability and control to implement an infrastructure strategy that outperforms any you've ever seen.

Efficient

- Up to 28% in energy savings
- Increase rack density up to 60%

Economical

- Reduce implementation costs compared to conventional data center approaches

Interoperable

- Maximize use of existing infrastructure
- Depending on the solution, you can have a complete infrastructure in just weeks

Controllable

- Easily enforce add / change policies
- Speed IT administration request response times by up to 30%



Smart Solutions
Intelligent, integrated infrastructure for the data center

SmartRow™

SmartMod™

SmartAisle™

The Smart Solutions family helps you cost-effectively achieve and manage higher levels of density, availability and efficiency.



SmartRow™
Intelligent, integrated
infrastructure
in a self-contained line-up

Capacity: 20kW

Racks: 3-6

Type: Self-contained

Floor: Primarily non-raised

Key Applications: Small data centers; remote sites; disaster recovery

The **SmartRow™ solution** has a room neutral design that lets you avoid many of the significant costs that come with a conventional data center buildout.

- Favorable implementation costs compared to using a conventional data center approach, due to savings from integrated fire suppression and ability to work in an existing non-raised floor environment without dedicated room cooling.
- Reduce energy consumption by up to 27% compared to a data center with conventional design, perform less maintenance and reduce the costs of adding new equipment.
- Order and install in just weeks.

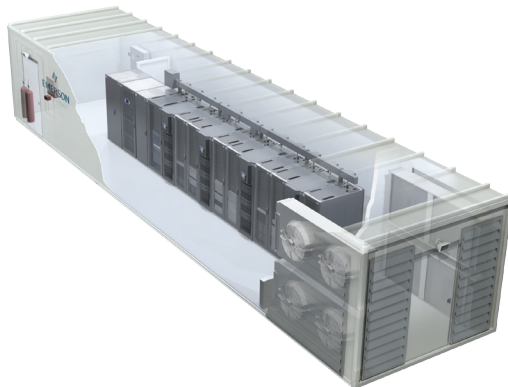

SmartMod™
Intelligent, integrated
infrastructure in a rapid
deployment enclosure.

Capacity: 30-400kW

Racks: 6-28

Type: Self-contained

Floor: N/A

Key Applications: Supplemental data center capacity; remote data centers; disaster recovery

The **SmartMod™ enclosure** lets you save on upfront design and implementation by delivering fully integrated power, precision cooling, integrated fire suppression and management systems in a modular, standalone design.

- Rapidly deploy a comprehensive data center infrastructure solution.
- Implement a stand-alone solution that won't burden the existing infrastructure.
- Save on design, equipment purchase and installation.
- Order and install in just months.
- Reduce energy consumption by up to 28% compared to a data center with conventional design.



SmartAisle™
Intelligent, integrated
infrastructure using
row-based building blocks.

Capacity: Most cost effective up to 400kW

Racks: Most cost-effective up to 40

Type: Open or aisle containment available

Floor: Raised, non-raised

Key Applications: Small and medium data centers; high-density zones in all data centers; new or retrofit

The **SmartAisle™ offering** can increase your efficiency through row-based power and precision cooling systems.

- Save up to 27% in energy costs
- Keep infrastructure on pace with equipment changes, with systems that operate together and can be quickly reconfigured
- Increase capacity without replacing old infrastructure.

Liebert MB Modular Busway: Flexible, Economical Power Delivery From PDU To Rack

Emerson Network Power brings you the most flexible, robust power distribution system on the market today: Liebert MB Modular Busway.

Modeled on the Siemens XJ-L busway, Liebert MB provides flexible modular power distribution in high tech environments. Power cables are replaced. Installation is simplified. Each rack has a clearly identified breaker. Air flows freely. Installation and ongoing costs are reduced. And the solution is organized and easy to maintain.

Liebert MB is a convenient, economical way to provide power from a room power distribution unit to the IT rack equipment. This compact, modular system is an organized alternative to custom cabling, and is a perfect solution for dynamic data centers that require frequent updates and changes with little to no power disruptions.

System Compatibility

Liebert MB is compatible with the Knurr DCM rack and the entire family of Liebert power products — rack and room PDUs, UPS systems and surge protective devices — providing power distribution and protection.

Ideally Suited For:

- Large or medium data centers.
- Data centers with variable and dynamic loads.
- High power density applications.
- Single or dual bus configurations.

Liebert MB Features:

- Comprehensive offering of standard fittings.
- Reconfigure to meet growing and changing IT demands.
- Lightweight and flexible for easy installation, but rugged enough for durability.
- 15-30% lower cost than typical cabling materials and labor/installation costs.
- UL 857 and CSA 22.2 agency ratings for safety.
- 100A, 225A and 400A availability.
- Hot swappable, user replaceable bus plugs provide both flexibility and maximum safety.
- Bus plug capacities from 30A to 100A.
- Pre-assembled bus plugs with whips or receptacles.
- Multiple bus plug port spacing available.
- Rack-mount, ceiling suspended or underfloor mounting options.
- Optional metering at bus plugs or tap box.

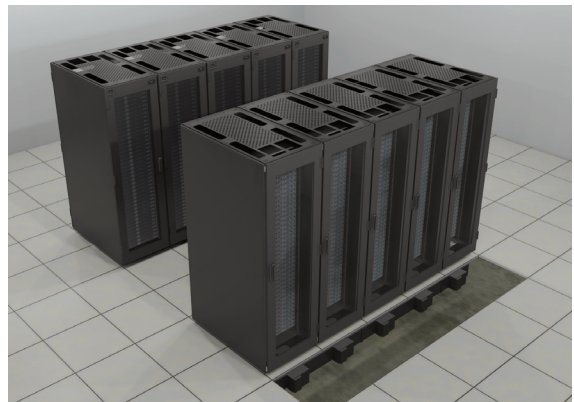
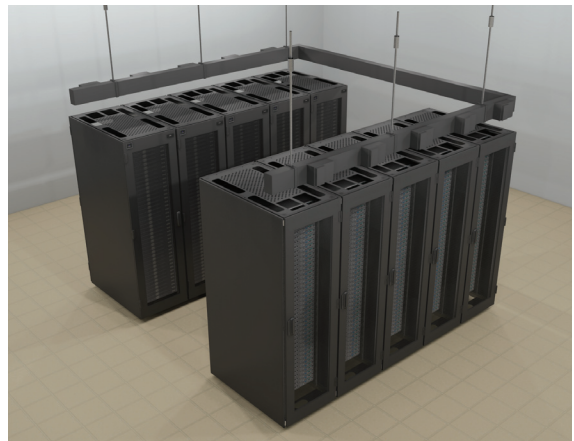
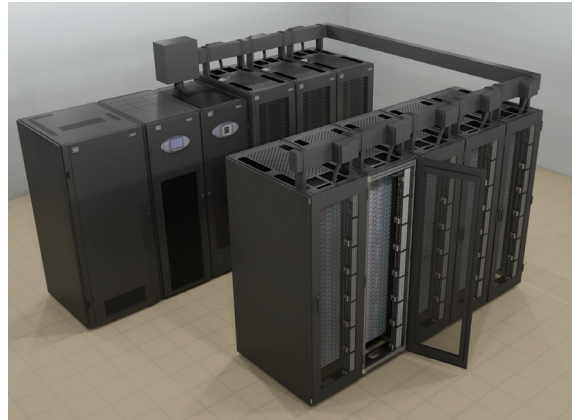

Liebert Power Monitoring Capabilities

The operation of Liebert MB can be monitored using:

- Liebert SiteScan® Web Centralized Monitoring System.

For more information, see pages 52 and 53.

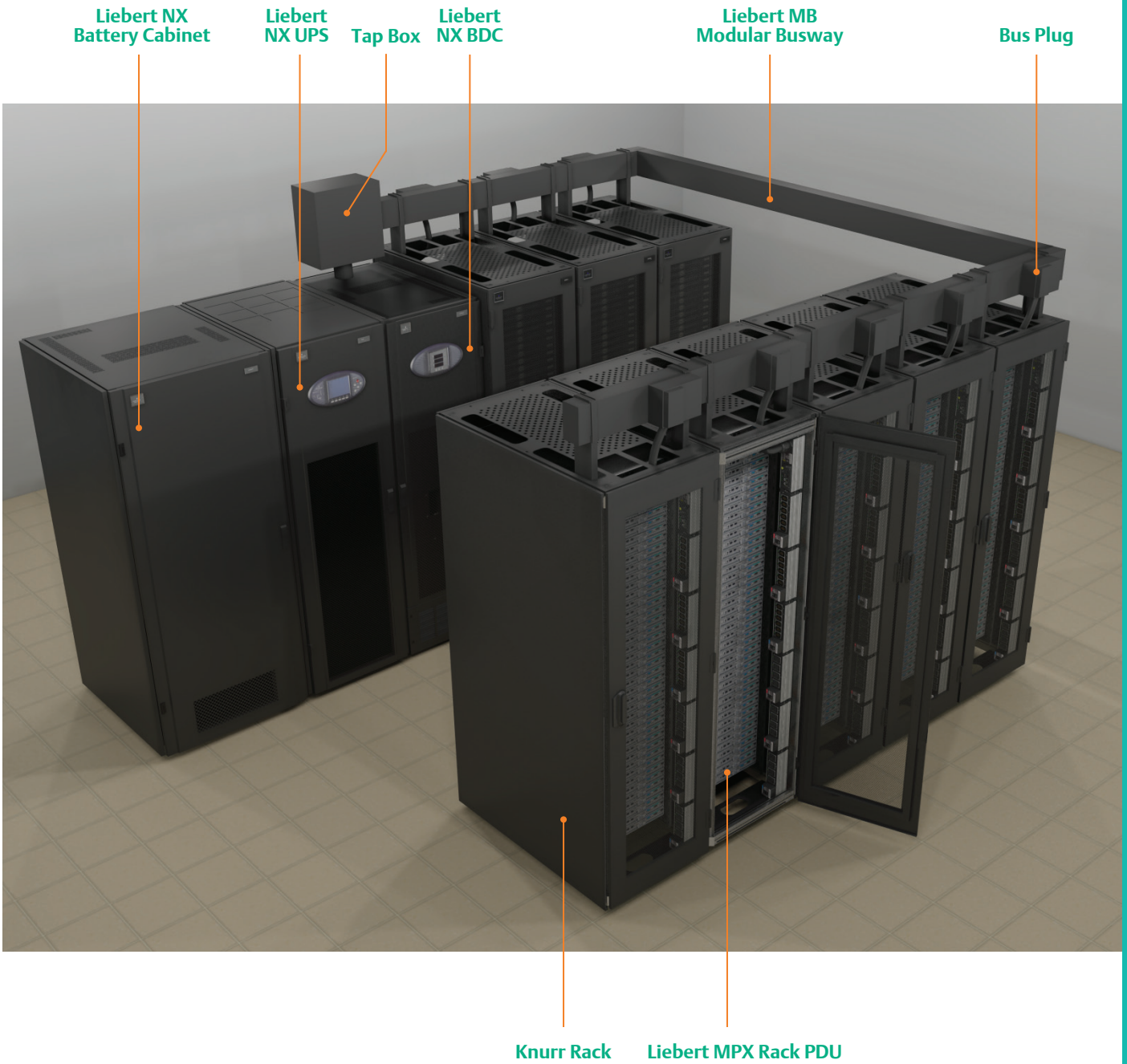

Liebert MPX - Adaptive Rack PDU: Respond To Change While Watching Your Bottom Line

Confidently take on the uncertain future of connected power requirements with Liebert MPX, the most responsive and adaptive rack PDU available. With Liebert MPX adaptive technology, you can economically increase availability of critical systems by leveraging hot-swappable modular power and managing power all the way to the receptacle level.

Liebert MPX Benefits:

- Adaptive capacity, distribution, monitoring, control and management of critical devices.
- Flexibility to respond to constant change.
- Buy only what you need and build on your investment.
- Secure communication.

Reconfigurable Power Capacity & Distribution

Liebert MPX is the perfect choice to respond to the needs of a growing data center. Relocate or add IT equipment to support changing needs, by easily reconfiguring the power input and distribution.

Liebert MPX Features:

- Industry leading operating temperature—up to 55 °C /131 °F to support hot Internal rack environments.
- Accurate power metering of +/-1% voltage & current for assured oversight.
- Energy and power metering down to the individual receptacle.
- Comprehensive alarming including notification of overloaded branch circuits.
- Environmental sensing with threshold and alarm set-points.
- Notification on the loss or removal of individual rack equipment loads.
- IP consolidation via Rack PDU Array™

Scalable Design Allows Onsite Configuration To Fit Immediate IT Equipment Needs.

The Liebert MPX Adaptive Rack PDU features essential characteristics to support fast-paced, growing data centers.

Hot Swappable Output Power
Deploy easily to get IT equipment online quickly

Receptacles & Modules
May be remotely controlled and metered, providing operator flexibility and allowing increased site security

Rack PDU Card (Liebert RPC)
Mounts in the Power Entry Module and provides upgradable network communications, sensor and local display interface

Input Power

- May be reconfigured to support changing power needs, single and three phase input.
- Can be positioned for top or bottom rack entrance.

Liebert Power Monitoring Capabilities

The operation of Liebert MPX can be monitored using:

- Liebert RPC Rack PDU Card.
 - Liebert Nform Monitoring System.
 - Liebert SiteScan® Web Centralized Monitoring System.
 - Secure Web/SNMP Interfaces.
 - Liebert RPC-BDM Local Display Module.

For more information, see page 18.



Liebert MPH—Managed Rack PDU: Advanced Monitoring And Control Support

Liebert MPH is a flexible Rack PDU solution with remote monitoring and control capabilities as well as environmental input options. It offers multiple power input selections and output configurations in both vertical zero-U and rackmount form factors. Up to four Liebert MPH PDUs may be interconnected as a Rack PDU Array™, consolidating user IP connections and device monitoring.

Liebert MPH Monitoring And Control Support

Monitored electrical parameters include: voltage, current, total real power (watt), and energy consumption (kW-hr). Capacity based current thresholds provide comprehensive alarm notifications from the Rack PDU and branch.

Liebert Power Monitoring Capabilities

The operation of Liebert MPH can be monitored using:

- Liebert RPC Rack PDU Card.
 - Liebert Nform Monitoring System.
 - Liebert SiteScan® Web Centralized Monitoring System.
 - Secure Web/SNMP Interfaces.
 - Liebert RPC-BDM Local Display Module.

For more information, see page 18.

Liebert MPH Features:

- Monitors electrical and environmental parameters with set threshold and alarm tools.
- Industry leading operating temperature—up to 55 °C/131 °F to support hot internal rack environments.
- Controls and manages individual receptacles.
- Predicts overcurrent conditions before they become critical.
- Remote monitoring at strip and branch.
- Card-based communications.
- Local displays are easily located to suit a crowded and changing rack environment.
- Supports mounting in 19" EIA, 42U rack environments—offered in vertical, zero U and rackmount form factors.
- Allows you to predict failing conditions before they occur and proactively manage connected equipment for maximum uptime.

Rack PDU Card (Liebert RPC)

Provides upgradable network communications, sensor and local display interface

Branch Overload Protection

Flexible Power Cord Mount

User adjustable for horizontal or vertical orientations



Liebert MPX and Liebert MPH: Enhanced Performance And Management Of Dynamic IT Spaces

IT Space Is A Dynamic Environment

Today's successful businesses depend on adaptable technologies to help them respond quickly to market demands. Your data center must be built on a support infrastructure designed to match the power and cooling needs of rapidly changing IT initiatives such as virtualization and consolidation. Each IT change, move or addition will affect the entire support infrastructure. You need products and support that ensure your IT systems will operate reliably in these environments.

Emerson Network Power's portfolio of products from brands such as Liebert, Knurr, Alber, Aperture, and ASCO provide innovative, flexible solutions that ensure reliability and efficiency. With the help of monitoring and management tools from Emerson Network Power, the result is an infrastructure that will enable you to proactively manage your critical IT spaces. The Rack PDU family of products is the connectivity point of IT systems into your power and cooling infrastructure and the critical interface to an efficient and effective infrastructure management ecosystem.

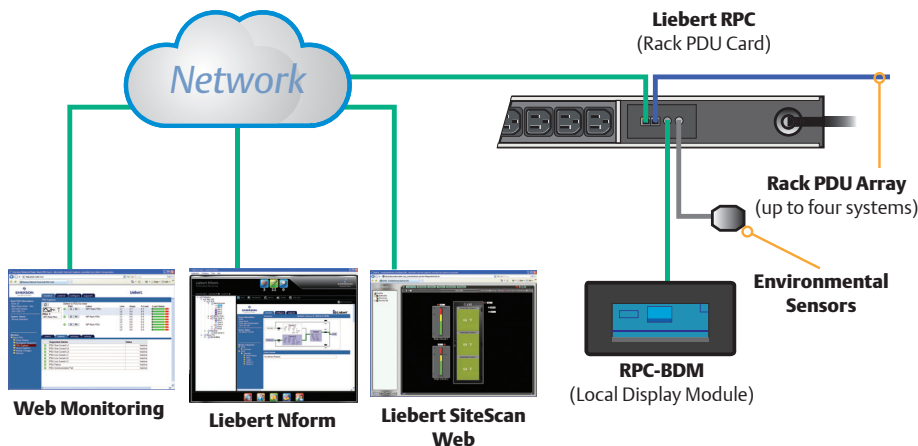
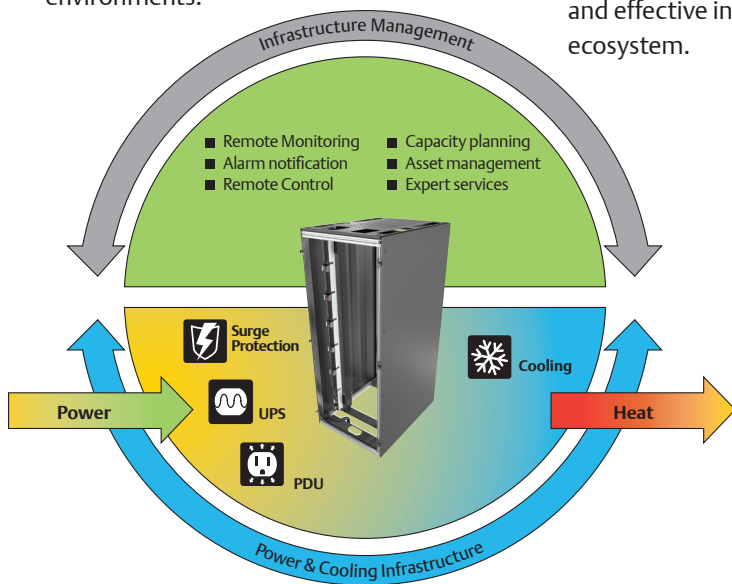

Monitoring Anywhere You Need It
From the individual receptacle of each discrete device to the complete rack PDU, monitoring is available to meet user needs. Displays are designed for easy user location to fit changing site needs.

Display and sensors are designed for easy mounting on the rack. A single display can manage up to four Liebert MPX or Liebert MPH systems and associated monitoring accessories. **Liebert MPX and Liebert MPH include the following capabilities:**

- Web-based monitoring.
- Liebert Nform IT based centralized monitoring.
- Liebert SiteScan centralized monitoring.
- User located local display with the ability to view up to four PDU's.
- Liebert SN rack sensors.

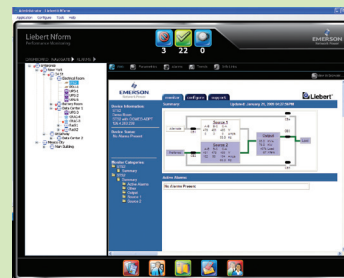

Liebert MPX may be remotely monitored and controlled via secure web/SNMP interfaces or Liebert Nform or Liebert SiteScan Web.



Status Display (RPC-BDM) is easily moved to the most convenient spot for the individual rack—even outside the rack. This tethered display may be located for user convenience.

Knurr DI-STRIP: Basic Rack PDU, Standard And HighPower Systems

Knurr Basic Rack PDU is the right answer for data center users selecting robust, economical and flexible rack power solutions.

Knurr DI-STRIP® meets a broad range of power distribution requirements for IT and other applications. Designed especially to handle the growing number of electronic components that can be housed within network cabinets and server racks, the space saving product line is available with a range of accessories including circuit breakers, overvoltage protection and more.



Flexibility to meet a broad range of requirements

Knurr DI-STRIP Features:

- Multiple configurations and input power options available including international compatibility.
- The addition of the Basic Rack PDU Expansion Unit allows for growth.
- 10ft. (3m) power supply cable offers room for movement.
- Reliable and robust solution.
- Worldwide approvals and certification.
- Full-length brass busbar on Standard models enhances operational reliability.
- Standard system extruded casing and a HighPower system heavy duty casing provide durability.
- Industry leading operating temperature—up to 55 °C/131 °F to support hot internal rack environments.
- Simple and quick installation on the rack's extrusion requires minimal space and reduces installation time.



Liebert PSP Stand-by UPS: 350 - 650VA, 1-Phase

Protection For Desktop And Small Network Applications

Liebert desktop power solutions are designed for applications where one or a few pieces of equipment require surge suppression or basic power protection with battery back-up.

One-On-One Protection

The Liebert family of products includes surge protection strips and line-interactive UPS to give you a real choice in desktop and network component protection.

Liebert Products Offer One-On-One Power Protection Solutions For:

- Home And Small Office Desktop PCs.
- Network Workstations.
- Network Routers, Bridges And Hubs.
- Point-of-Sale Terminals.
- Other Sensitive Electronics.

The PowerSure PSP from Liebert is a compact, full featured UPS that delivers cost-effective power protection. Designed with simple controls for easy operation, the PowerSure PSP provides over four minutes of battery back-up at full load — more than enough time to save work in process and shut down your system.

Perfect for desktop applications, the PowerSure PSP provides one-on-one power protection for PCs and other sensitive electronic equipment. Two models available: 350 and 500VA at 120VAC and 500 and 650VA at 230 VAC.

For maximum flexibility, a choice of communications options are available — USB, serial or contact closure. This option solves the legacy systems dilemma of what to do with equipment that does not have USB capabilities. A MultiLink™ automated shutdown software CD, serial communications cable and USB cable are also included.

Liebert PSP Features:

- Three battery-backed UPS outlets.
- One surge protection-only outlet.
- Up to five minutes of battery backup at full load.
- User replaceable batteries.
- RJ-45 port for data line surge protection.
- Advance early warning of UPS shutdown.
- USB port, Liebert MultiLink Software shutdown software and USB cable.
- Two-year replacement warranty.

Stand-by UPS

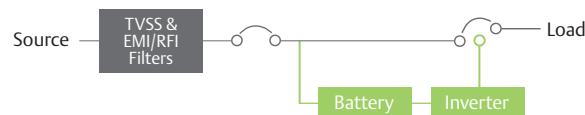

Liebert Power Monitoring Capabilities

The operation of the Liebert PSP can be monitored using:

- Liebert MultiLink® Automated System Shutdown Software.

For more information, see pages 52 and 53.



Liebert PSA Line-Interactive UPS: 500 – 1500 VA, 1-Phase

High-Performance Power Protection For PC's And Office Equipment

Liebert PSA is an economical line-interactive UPS that offers full-featured power protection for small office computers and electronic equipment. It is available in the following sizes: 500, 650, 1000 and 1500 VA at 120 VAC or 230 VAC.

Designed with simple controls for easy operation, the Liebert PSA provides up to five minutes of back-up time at full load – more than enough time to save work in process and shut down your connected equipment. USB shutdown software and a USB cable are also included, to allow remote alerts and automated graceful shutdown of the connected systems. Liebert PSA offers unique features and extraordinary performance not normally found in similar products in this price range.

Other Standard Features Included On All Liebert PSA Models:

- Three to six battery-backed UPS outlets, depending on model size.
- One to two surge-only outlets, differentiated by color.
- Up to five minutes of battery backup time at full load.
- User replaceable batteries.
- Advance early warning of UPS shutdown.
- RJ-45 port for data line surge protection.
- Two-year warranty.

Line-Interactive UPS

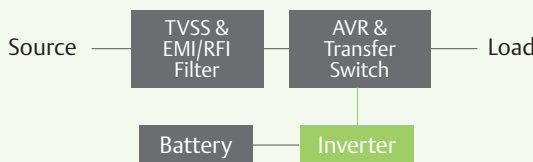

500/650 VA back view



1000/1500 VA back view



Liebert Power Monitoring Capabilities

The operation of the Liebert PSA can be monitored using:

- Liebert MultiLink® Automated System Shutdown Software.

For more information, see pages 52 and 53.

Liebert PSI And Liebert PSI-XR Line-Interactive UPS: 750-3000VA, 1-phase

Rack-Mounted Power Solutions For Growing IT Networks

Rack-mounted servers are at the heart of today's network computing systems. These critical components need reliable, compact power protection that will keep pace with their growing needs.

Protection That Fits In Anywhere

From line-interactive units to true on-line models, Liebert rack-mount UPS systems are designed for reliability and space-saving flexibility. No one packs more power capacity and features into a smaller package.

Liebert Has Rack-Mount UPS Solutions For:

- PCs.
- Network Workstations.
- Servers and Critical Nodes.
- Network Routers, Bridges and Hubs.
- Large Network Peripherals.
- Network Closets.
- VoIP.
- Storage Systems.
- Point-of-Sale Terminals.
- Test Equipment.
- Other Sensitive Electronics.



Proven high-level performance and reliability for server and network power protection.

Designed for the IT environment, Liebert PSI UPS and the Liebert PSI-XR extended battery model are slim 2U sized rack/tower style, line-interactive UPS systems. They offer configurable input voltage windows allowing the customer to precisely match their input voltage. A choice of communications options includes serial, contact closure and USB. Available in 750, 1000, 1500, 2200, and 3000 VA in 120 and 230VAC models.

Other Standard Features Of Liebert PSI And Liebert PSI-XR:

- Seven to eight battery-backed outlets.
- 0.9 Output Power Factor.
- Rotatable display panel.
- Automatic frequency sensing.
- Wider input voltage window.
- RJ-45 Data line surge protection.
- Advance early warning of UPS system status.
- Hot swappable batteries.
- Up to five minutes of battery backup time at full load when utility fails.
- External battery cabinet available for Liebert PSI-XR models.
- Site wiring fault indicator.
- USB communications, serial and contact closure communication option.
- Remote emergency power off.
- Rack rail kit included.
- Two-year warranty.
- Liebert PSI-W and Liebert PSI-XRW web-enabled models ship with IS-WEBRT3 card installed, for fast deployment.

Optional Liebert MicroPOD 2U POD output distribution and maintenance bypass module ensures continuous uptime, even during UPS maintenance.



Line-Interactive UPS With Power-Factor Correction

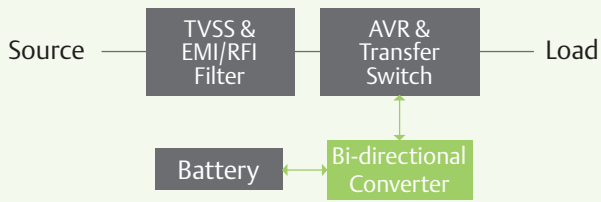

Liebert PSI-XR UPS With Internal Battery

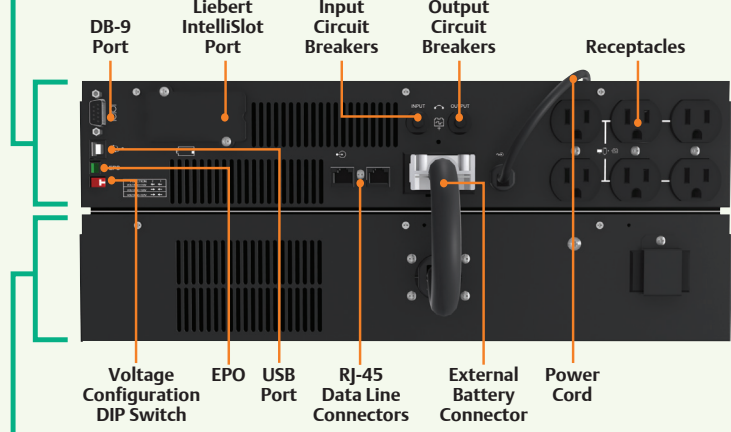

Optional External Battery Cabinet
Add up to six cabinets for additional runtime

Liebert PSI UPS With Internal Battery

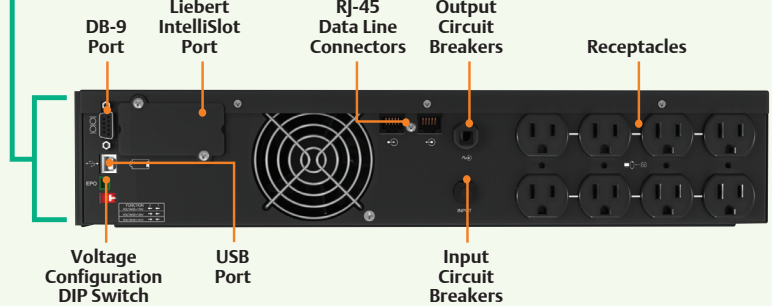

Liebert Power Monitoring Capabilities

The operation of Liebert PSI can be monitored using:

- Liebert MultiLink® Automated System Shutdown Software.
- Liebert Nform Monitoring System.

For more information, see pages 52 and 53.

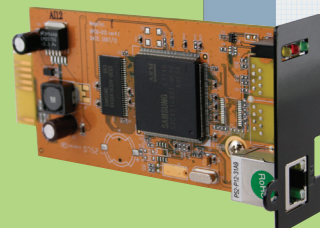
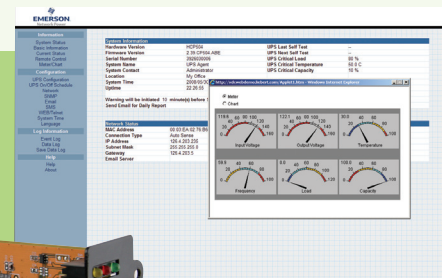

Optional Liebert IntelliSlot Web Card (PS ISWEBCARD) provides SNMP and web-based management

Liebert GXT3 On-Line UPS: 500-3000VA, 1-phase



Compact UPS combines on-line reliability, configurability and internal batteries.

Liebert GXT3 leads the industry in combining small size, high capacity and multiple features. Designed to be either rack-mounted or installed in a tower configuration, the UPS is available in 500, 700, 1000, 1500, 2000 and 3000 VA ratings, in both 120 V and 230 V models.

A true on-line UPS, Liebert GXT3 includes features such as power factor correction, internal batteries, frequency conversion, unlimited external battery connectability and internal bypass capability. And all this is housed in a smaller 2U size cabinet that cuts space requirements in half while providing up to 3 kVA of true on-line power – batteries included. The UPS can also be used with external batteries for extended run times.

A Windows™ configuration program, included with each unit allows the user to program a variety of operating parameters. This capability allows you to

customize Liebert GXT3 performance to your specific requirements, providing a new level of power protection control and adaptability.

Other Features Of Liebert GXT3 2U Models:

- Microprocessor-based control and monitoring package.
- Input power factor correction.
- PWM inverter.
- Integral dynamic bypass.
- Integral sealed, non-spillable, hot-swappable battery.
- Automatic and manual battery test feature with push button and indicator.
- Input and output noise suppression.
- USB port.
- Liebert IntelliSlot® communications port.
- Two-year no-hassle replacement warranty.

On-line UPS

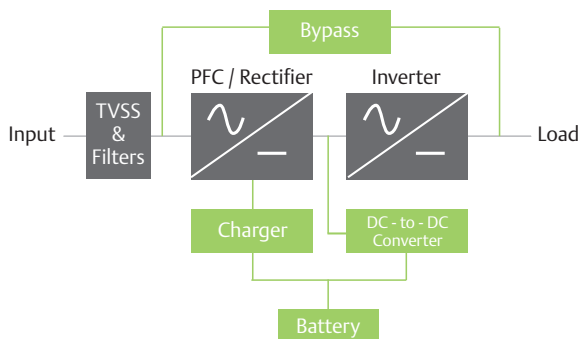

Liebert Power Monitoring Capabilities

- The operation of the Liebert GXT3 can be monitored using:
- Liebert MultiLink® Automated System Shutdown Software.
 - Liebert Nform Monitoring System.
 - Liebert SiteScan® Web Centralized Monitoring System.
 - Third-Party Monitoring Systems.

For more information, see pages 52 and 53.



GXT3 Rear View



Optional Liebert MicroPOD 2U POD output distribution and maintenance bypass module ensures continuous uptime, even during UPS maintenance.

Liebert GXT3 On-line UPS: 5kVA-10kVA 1-phase



The internal battery packs are hot-swappable, and user replaceable. The unit also supports up to four external battery cabinets for extended run time.

High capacity, compact on-line UPS with flexible output voltage and power distribution.



Liebert GXT3 UPS meets the need for higher power capacities in small spaces with these 5kVA-10kVA UPS systems. These true on-line double conversion UPS systems feature integrated maintenance bypass, as well as optional extended battery runtime.

Designed for use in either rack or tower configurations, all units offer the smallest available solutions for these power capacities — the 5 & 6kVA model at 120/208V output in 4U size, or the 8 & 10kVA unit 120/208V output in a 6U package. A 6kVA 208V output 5U size model is also available.

To help meet the need for choosing a single supplier for global applications, 220V, 230V and 240V 50/60 Hz models are offered with CE and C-tick markings.

Dual Voltages For Multiple Applications

Simultaneous output voltages of 240/120, 208/120, 230/115, 220/110, or 200/100 VAC provide the flexibility to adapt to multiple load requirements without the need to add additional transformers that take up extra space and add weight.

Other Product Features Of Liebert GXT3 5kVA-10kVA UPS Models Include:

- User replaceable hot-swappable internal batteries. Provide four minutes of runtime at full load.
- Additional runtime with additional battery cabinets.
- Built-in USB communications for use with Liebert MultiLink™ Automated Shutdown Software. Allows you to monitor communication between the UPS and a server, and ensures a graceful unattended shutdown.
- Built-in closure signals. Provides notification to monitoring systems of operating conditions including: on battery, low battery, battery mode shutdown and any mode shutdown.

- Emergency Power Off (EPO). Terminal connections for a normally open or normally closed emergency power off switch.
- Wider input voltage window minimizes battery use — allows the UPS to support the critical load without having to transfer to battery, extending system availability for when battery back-up is truly needed.
- Internal automatic and manual bypass. Assures continuity of power to critical loads during system maintenance or in case of internal fault.
- Self-diagnostics. Automatically tests unit electronics and batteries simplifying maintenance and troubleshooting.
- Liebert IntelliSlot Web Card provides SNMP and web-based monitoring and control of UPS.
- Standard two-year replacement warranty. No-hassle warranty provides paid shipping both ways. Optional one-year and three year extensions available.

Liebert Power Monitoring Capabilities

The operation of the UPS can be monitored using:

- Liebert IntelliSlot Web Card.
- Liebert MultiLink® Automated System Shutdown Software.
- Liebert Nform Monitoring System.
- Liebert SiteScan® Web Centralized Monitoring System.
- Liebert Universal Monitor And Remote Power Monitor Panels.
- Third-Party Monitoring Systems.

For more information, see pages 52 and 53.

Liebert Nfinity® On-Line UPS: 4-20 kVA, 1-phase



Protecting The Enterprise: High Availability UPS Protection For Mission-Critical Applications

The need to safeguard critical operations from power problems can be solved through the use of large-scale UPS systems.

A Powerful Defense Against Uptime Threats

Liebert offers a full range of enterprise power protection solutions for any size facility from a small computer room to the largest data and communications centers.

Liebert Enterprise UPS Solutions Are Ideal For

- Large-Scale Data Centers.
- Facility-Wide Networks.
- Large-Scale Telecommunications Centers.
- Colocation Facilities.
- Internet Data Centers.
- Server Farms.
- Data Warehouses.
- Network Management Centers.
- Medical Imaging Equipment.
- Test and Laboratory Facilities.
- Industrial Process Control Operations.

The Liebert Nfinity power system is a scalable 4 to 16 kVA or 12 to 20 kVA UPS designed with N+x parallel redundancy to provide a fault-tolerant network of power protection.

The modular design of the Liebert Nfinity power system was devised to provide easy scalability to users as their power demands grow. Configurations can be cost-effectively upgraded without re-investing in a new system or installation.

A True On-Line System That Delivers Continuous, Regenerated Sinewave Output Power

The Liebert Nfinity is a true on-line, double-conversion UPS that provides 100% power conditioning, zero transfer time to battery, no change in output voltage and better transient suppression than line-interactive units.

Its unique frame design houses all of the modular system components, including 4 kVA power modules, battery modules and system control modules. By simply installing additional power or battery modules, you can expand your current system, extend backup runtime or add redundancy.

- Intelligent power modules provide protection from all power aberrations, and a patent pending electrical current-sharing technology provides equal distribution of power among all modules.
- The IntelliBattery™ modules utilize multiple sensors to continuously monitor battery voltage, current and temperature to determine and predict performance.
- The IntelliControl™ module works with the user interface to provide vital information about the condition of the power and battery modules.

Liebert Power Monitoring Capabilities

The operation of the Liebert Nfinity® UPS can be monitored using:

- Liebert IntelliSlot Web Card.
- Liebert MultiLink® Automated System Shutdown Software.
- Liebert SiteScan® Web Centralized Monitoring System.

For more information, see pages 52 and 53.

Additional Features Of The Liebert Nfinity Power System:

- Hot-swappable modules allow the user to replace modules or upgrade the system without disturbing connected equipment.
- Continuous self-diagnostics detect and isolate faults to prevent cascading system failures, as well as to simplify maintenance and troubleshooting.
- Patent pending intelligent bypass technology provides seamless transfers to and from the bypass source.
- Wide input voltage window minimizes battery operation to maximize battery life.
- Fully assembled and factory-tested, simple to install and ready for use for a plug-and-play solution that is functional right out of the box.
- Additional battery cabinets can be added for backup times up to 72 hours.
- Two-year limited warranty for repair or replacement with warranty extensions also available.

Liebert NX On-Line UPS: 10-30 kVA, 3-phase

Power designed to grow with your needs.

The Liebert NX 10-30 kVA product family offers true on-line, double conversion, three-phase UPS systems that deliver complete, centralized power protection for mission-critical systems. Available in 10, 15, 20 & 30 kVA capacities, these rugged units are designed to meet the high availability power needs of a wide variety of IT applications. Liebert NX 10-30 kVA UPS systems combine advanced operating features, compact size and low cost of ownership in a range of sizes to suit room or data center needs.

The “all-in-one” design of the Liebert NX 10-30 kVA UPS provides more protection security and efficiency than using separate, smaller power units spread throughout the facility. The Liebert NX delivers complete protection with a true on-line IGBT-based double conversion design. The system’s advanced topology features a digital signal processor controlled IGBT rectifier and IGBT inverter.



Liebert Power Monitoring Capabilities

The operation of the Liebert NX 10-30 kVA UPS can be monitored using:

- Liebert IntelliSlot Web Card.
- Liebert MultiLink® Automated System Shutdown Software.
- Liebert Nform™ Monitoring System.
- Liebert SiteScan® Web Centralized Monitoring System.
- Third-Party Monitoring Systems.

For more information, see pages 52 and 53.



Other Features Of Liebert NX 10-30 kVA UPS Models:

- Increases growth flexibility by handling larger loads, and offers the ability to parallel like-sized 20 and 30 kVA modules for increased capacity and redundancy.
- Achieves higher availability by reducing the number of UPS units required to power your room.
- Reduces total cost of ownership through the use of longer life batteries and simplified preventive maintenance.
- Wider input voltage window and frequency tolerances contribute to higher system availability by minimizing battery usage.
- Operates under a wide variety of conditions, handling 100% nonlinear loads with 3:1 crest factor, as well as 100% unbalanced loading.
- IGBT-based power factor corrected rectifier enables the Liebert NX to achieve its impressive THD and PF performance.
- Advanced inverter control technology provides the highest output power quality, ensuring very low output voltage THD and superior waveform to protect connected loads.
- Fully digital control technology provides a highly accurate, drift-proof control compared to traditional analog electronics.

Liebert NX On-Line UPS: 40-200 kVA, 3-phase

Now There's A Data Center UPS That Matches Your Growth Plans.

For high availability, high capacity applications, the transformerless Liebert NX 40-200kVA UPS systems offer true on-line, double conversion technology to protect and condition against the full range of power irregularities. Plus they do it with a level of flexibility not previously found in systems of this size.

A wider input voltage window and frequency tolerances help to minimize transfers to battery, reducing the number of charging and discharging cycles. Availability is also enhanced with a triple mode battery charger that enables fast battery recharge. Longer battery backup time may be achieved by paralleling additional battery cabinets to the system.

Softscale™ technology provides flexibility to increase UPS capacity without changes in your infrastructure. From 40 up to 80kVA, 80 up to 120, and 160 to 200. You may also parallel UPS modules for capacity and redundancy.

The Liebert NX power core combined with the optional Liebert NX BDC (Bypass Distribution Cabinet) lets you simplify power distribution and voltage conversion. This combination provides packaged power distribution for today's rack-based data centers and IT facilities.



Liebert Power Monitoring Capabilities

The operation of the Liebert NX 40-200 kVA UPS can be monitored using:

- Liebert IntelliSlot Web Card.
- Liebert MultiLink® Automated System Shutdown Software.
- Liebert Nform™ Monitoring System.
- Liebert SiteScan® Web Centralized Monitoring System.
- Third-Party Monitoring Systems.

For more information, see pages 52 and 53.

Liebert NX UPS 160-200 kVA

Cutting-Edge Power Technology Makes The Difference

Liebert NX UPS Systems Incorporate A Number Of Other Exceptional Features:

- High overload rating handles 125% for 10 minutes, 150% for one minute and a 1000% overload for 10 milliseconds.
- Digital controls provide the fastest possible power management to enhance reliability, accuracy and efficiency.
- Front access models available for installation along a wall. Front and rear access models available for installation in a row.
- Compact footprint requires less floor space, leaving you with more room for other equipment.
- Load Bus Synchronization standard.
- Soft Switching technology increases efficiency by up to 2% and saves energy.
- Integrated ground fault detection allows for effective transformer-less design while saving space and lowering the unit weight.
- Parallel for redundancy or capacity.
- Active input rectifier is generator and utility friendly.
- Web card monitoring standard.
- One year warranty.



Liebert NX Power Core
40-80 kVA

Softscale™ technology, paralleling capabilities and Eco-mode™ all contribute to lower initial, incremental and operating costs.

Liebert NX 40-200 kVA UPS Systems Softscale Technology

Liebert NX 40-200 kVA UPS systems have Softscale technology that provides flexibility to increase UPS capacity by 20 or 40kVA without changes in your infrastructure. Allows paralleling of unlike-sized models for capacity or redundancy. Designed for optimized performance with the same high efficiency at 40% utilization as at 100% utilization.

Paralleling Capabilities

Liebert NX 40-200 kVA systems allow you to parallel UPS modules for capacity and redundancy, eliminating the batteries as a single point of failure because each UPS has its own isolated battery. Liebert NX also features integrated dual bus synchronization as a standard feature. This provides the capability to synchronize the outputs of two independent UPS modules when they are configured as a redundant system feeding independent distribution paths.

Eco-Mode High Efficiency Configuration

If selected, this operating mode switches the UPS to static bypass during normal operation, increasing efficiency to up to 97% at full load. When power problems are detected the UPS automatically switches back to double conversion mode.

Liebert NX BDC

The optional Liebert NX BDC provides flexibility in input and output voltage for a variety of applications. This cabinet is available in capacities to cover the Liebert NX UPS range of 40-200kVA. The monitoring panel matches the UPS unit. Power and control cabling from this cabinet to the UPS is included, enhancing ease of installation and availability. For ease of installation and maintenance, the cabinet offers top or bottom cable entry and models are available in front and rear access, or front access only configurations.

Liebert APM™ On-line UPS with FlexPower Technology: 15-90kVA, 3-phase

Liebert APM is a transformer-free, on-line UPS that allows quick and easy capacity increases with the addition of rack-mounted FlexPower™ core hardware assemblies. The core assemblies allow the UPS to expand for capacity or redundancy in 15kW increments within a single cabinet — 15kW to 45kW or 90kW. No additional floorspace is required. FlexPower core assemblies may even be added without powering down connected equipment.

On-line double-conversion technology and internal redundancy combine to provide protection from the full range of power irregularities, offering the highest availability.

With efficiencies of up to 94% at typical load levels, Liebert APM offers one of the industry's highest efficiency ratings. The UPS is even more efficient when sized in accordance with present system needs, instead of purchasing a larger capacity system to anticipate future requirements.

The cost-efficient Liebert APM provides the reliability of an enterprise UPS, and the flexibility to adapt to increasing power demands. This is a true, best-in-class solution from the leader in power and cooling solutions for computer rooms and data centers. Key features and benefits include:

- **Up to 94% efficiency** — High efficiency results in lower energy consumption
- **Front service access** — for quick and easy installation
- **Transformer-free design** — provides a smaller footprint and lower cost compared to transformer-based systems
- **Matching bypass and distribution cabinet** — increase reliability and safety by switching the protected load to bypass power for maintenance and service
- **Matching battery cabinets** — provides added back-up capacity for extended runtimes
- **Distributed controls** — each FlexPower core assembly includes DSP controls, minimizing possibility of single point of failure
- **Standalone static bypass module** — features independent controls in separate assembly to provide higher reliability
- **Top or bottom cable entry** — enables installation on raised or non-raised floors
- **Large dot-matrix monitor with graphical display** — allows easy viewing and comprehensive system information Includes three Liebert
- **IntelliSlot ports for web-based communications ability** — Liebert IntelliSlot card IS-485EXI allows communication with Liebert SiteScan; Liebert IntelliSlot card IS-WEBL allows communication with Liebert Nform (90 day license included)
- **One-year warranty** — provides full system coverage for one year



Liebert APM BDC, Liebert APM 90 kW FlexPower Core, and Liebert APM External Battery Cabinet



Other Product Features Of Liebert APM UPS Include:

- Internal bypass allows FlexPower assemblies to be added or replaced without powering down the connected equipment
- 45kW model includes internal batteries. More runtime is available with optional external battery cabinets
- 90kW units use optional external battery cabinets for battery runtime
- Conveniently positioned, easy-to-reach power terminations simplify unit wiring and installation
- Enterprise-quality batteries in an external battery cabinet provides backup time for 90kW frame size, and additional runtime for 45kW frame size
- Withstand rating of 65kAIC ensures reliability and safety under even the most extreme utility conditions
- Unity power factor design (kW=kVA) is optimized for today's high power factor loads

Liebert APM is ideally suited for:

- Small to medium-size data centers
- Server rooms
- Production areas
- Labs and testing facilities
- Telecommunications or process control centers

Liebert APM 90kW FlexPower Core



Liebert Power Monitoring Capabilities

The operation of the Liebert Series 610 UPS can be monitored using:

- Liebert IntelliSlot Web Card.
- Liebert MultiLink® Automated System Shutdown Software.
- Liebert Nform Monitoring System.
- Liebert SiteScan® Web Centralized Monitoring System.
- Liebert Universal Monitor And Remote Power Monitor Panels.
- Third-Party Monitoring Systems.

For more information, see pages 52 and 53.

Liebert Npower™ On-Line UPS: 30-90 kVA, 3-phase

Liebert Npower is the next generation of large-scale UPS, utilizing true double-conversion on-line technology to protect against the full spectrum of input and output power disturbances. Liebert Npower's all-digital ActiveStar™ controls are DSPbased and feature a unique, patent-pending technology that allows it to make ultra-fast adjustments to changing loads, including subcycle pulse-width corrections to keep the output voltage waveform nearly flawless. The Liebert Npower system is available in seven models ranging from 30 kVA up to 130 kVA.

The Liebert Npower is rugged enough to handle load branch faults, input faults, 100% step loads, PDU startup inrush and motor-load startup. Output voltage distortion (THD) typically measures less than 2.5% — even under worst-case conditions. The combination of rugged inverter and continuous rated static switch gives the Liebert Npower exceptional overload capability.



Liebert Npower UPS

Standard And Optional Features Of The Liebert Npower UPS:

- 1+1 redundant configurations (for single-bus systems) that allow concurrent maintenance resulting in virtually 100% availability of conditioned power
- Load bus synchronization option for dual-bus systems with two power feeds for added availability (for use with Liebert transfer switches or dual-input PDUs)
- Excellent efficiency powering non-linear, unbalanced and crest loads
- Small footprint in a full-featured system
- Exceptional overload and transient performance
- All DSP-controlled UPS
- Easy-to-read screen and navigation menu on a large LCD display
- Superior battery algorithms used to minimize operation of batteries and include self-test and temperature compensated charging

Liebert Power Monitoring Capabilities

The operation of the Liebert NX 40-200 kVA UPS can be monitored using:

- Liebert MultiLink® Automated System Shutdown Software.
- Liebert Nform™ Monitoring System.
- Liebert SiteScan® Web Centralized Monitoring System.
- Liebert Universal Monitor And Remote Power Monitor Panels.
- Third-Party Monitoring Systems.
- Albér Battery Monitoring.

For more information, see pages 52 and 53.



Great Value in a Mid-Range UPS

The Liebert Npower gives you more UPS for about the same initial cost as lesser products. Furthermore, the Npower will usually cost significantly less over the lifetime of the product. The value comes from several elements: exceptional protection, higher efficiency, lower installation, maintenance and operating costs, smaller total system footprint and more standard features.

Higher Efficiency in Real-World Applications

Critical applications require a UPS to have an input filter (to reduce input current distortion) and an output isolation transformer (to isolate your critical load), while powering non-linear (high-crest-factor) loads at less than the rated capacity of the UPS.

The fully equipped Liebert Npower has excellent efficiency — typically between 92% and 93.5% — while powering high-crest-factor loads between 50 and 100% of its rated capacity. Furthermore, the input power factor is exceptionally high, typically 0.95 to 0.96 for models with 480 VAC input.

In this power range (up to 130 kVA), the only way to exceed 93.5% efficiency is to leave out something important. Some competitors omit the output isolation transformer; others put your critical load at risk with their single-conversion UPS products. Only you can decide if the claimed savings justify the risk.

High-Availability Configurations

The Liebert Npower UPS can be used reliably as a single module and in various redundant configurations. The Npower 1+1 Redundant option, described on pages 10-11 of this brochure, is a cost-effective parallel-redundant system. Parallel redundancy improves maintainability and fault tolerance, thereby enhancing system availability.

For the ultimate in high-availability systems, Npower can be applied in various distributed-redundant (dual-bus) configurations, using our unique Load Bus Sync™ option. Both Load Bus Sync and 1+1 Redundant configurations can be factory-installed or retrofitted to existing Npower installations.

Liebert NXL On-Line UPS: 250-750 kVA, 3-phase

Liebert NXL—Stack Up Performance

100% Load
Low & High Line Conditions
40 °C / 104 °F Temperature
50% Clogged Air Filter
Fan Failure
High Altitude 1500 Meters

Liebert NXL is designed to handle all severe conditions simultaneously and still support 100% load with no need for derating.

Liebert NXL UPS Provides Reliable Power Protection And Advanced Technology For High Power Applications.

The industry's most reliable power protection and advanced technology has been combined into a new generation of three-phase UPS systems for high power applications — the Liebert NXL from Emerson Network Power.

Available in 250, 300, 400, 500, 625 and 750 kVA single module models and multi-module systems, the transformer-based Liebert NXL provides excellent dynamic performance, with the ability to handle virtually any input condition while still providing computer grade output to critical loads.

The leader in large UPS system installations, Emerson offers complete and unequalled support, including engineering consultation, the largest and most widespread factory-trained service organization, and the industry's largest and most advanced production and witness test facility.

Other Liebert NXL Features Include:

- Matching battery and maintenance bypass cabinets for easy configuration.
- Top or bottom cable entry.
- Internal cabinet cable wiring simplifies installation.
- Ship-ahead I/O section can be installed before UPS installation.
- Liebert ActiveStar® Digital Signal Processor (DSP) controls—no potentiometers.
- Redundant components—fans, power supplies, and communications cards.
- Provides superior handling of present and future computer loads, up to 0.95 leading power factor without derating.
- Color touch screen controls improve user interface and reduce risk of human error.
- Excellent dynamic performance and fault tolerance.
- Generator and utility friendly with low current distortion.
- Front access for installation and service.
- Compact cabinets require less floor space.
- Inter-cabinet cabling requires less hard wiring.
- Built-in battery cabinet breaker isolates string for ease of service.
- Energy efficient operation, with up to 94% operating efficiency.
- First large UPS to be tested and UL Listed to UL1778 Fourth Edition, which requires testing of every specification.

Liebert NXL UPS

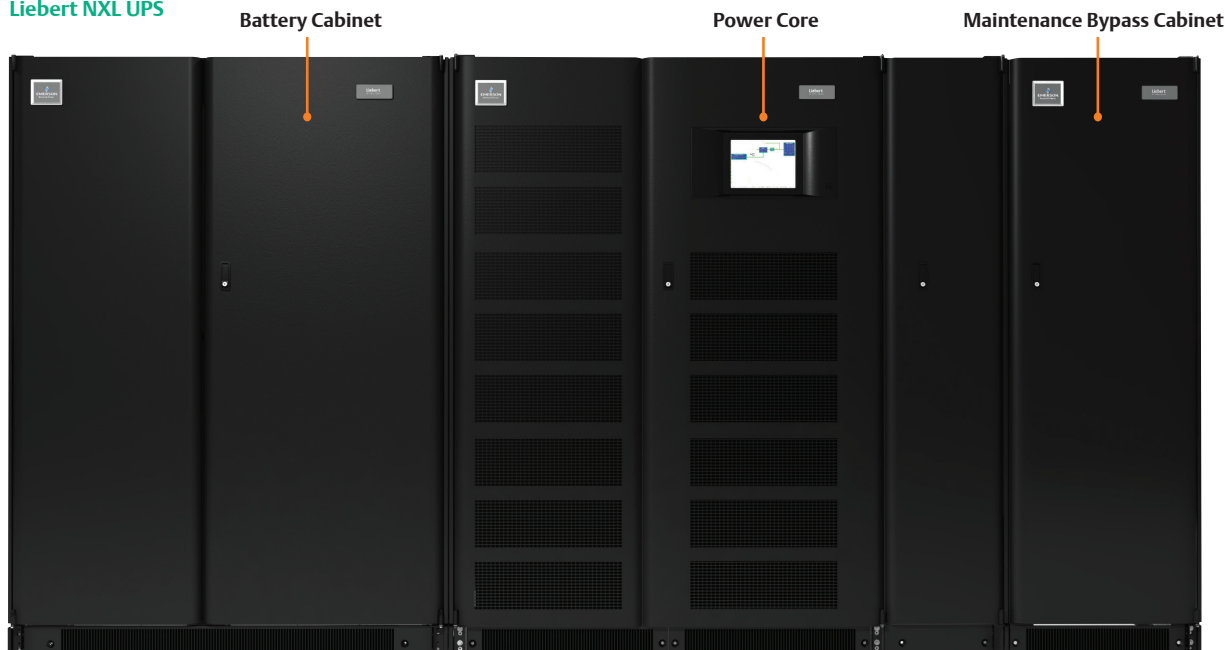

Liebert Power Monitoring Capabilities

The operation of the Liebert NXL UPS can be monitored using:

- Liebert MultiLink® Automated System Shutdown Software.
- Liebert Nform™ Monitoring System.
- Liebert SiteScan® Web Centralized Monitoring System.
- Liebert Universal Monitor and Remote Power Monitor Panels.
- Third-Party Monitoring Systems.
- Four Liebert IntelliSlot ports. Ships with standard 485 Liebert SiteScan Web interface.
- Albér BDSi Integrated Battery Monitoring System.

For more information, see pages 52 and 53.



Optimized Performance

Intelligent Eco-Mode™ — Liebert NXL offers up to 97% full load efficiency during user-selectable Intelligent Eco-Mode™ operation. The always-on inverter ensures high availability and seamlessly assumes the load in case of a utility power disturbance.

Intelligent Paralleling™ — Modules paralleled with a system control cabinet (N+1 configuration) may be customer selected to use Intelligent Paralleling, which increases efficiency by turning off redundant modules. Off time is equally distributed between all modules.

Configuration Options

Single-Module Configuration (250-750kVA models)

- Single-module systems provide a basic protection configuration.
- The critical bus is powered by a single UPS system with bypass capability.

1+N Parallel Configuration (250-750kVA models)

- Paralleling of single UPS units, offers easy scalability for increased capacity or redundancy
- Each unit has its own static switch for bypass
- Provides redundant capacity without the need for a system control cabinet

N+1 Parallel Configuration (500-750kVA models)

- Paralleling of Multi Module units, without built-in static switch
- Requires System Control Cabinet with centralized static switch
- System Control Cabinet can be easily integrated into any switchgear solution
- System rated static switch with bypass breaker offers high fault clearing capability, and high availability
- Centralized monitoring allows good visibility and easy control of total system
- Up to six units may be used together for capacity/ redundancy

Liebert NXL Single Module System One-Line (250-750 kVA)

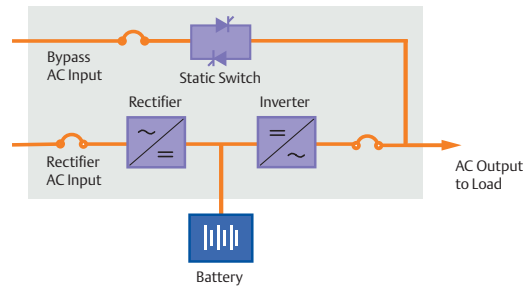

Liebert NXL 1+N Multi-Module System One-Line (250-750kVA) Distributed Static Switch

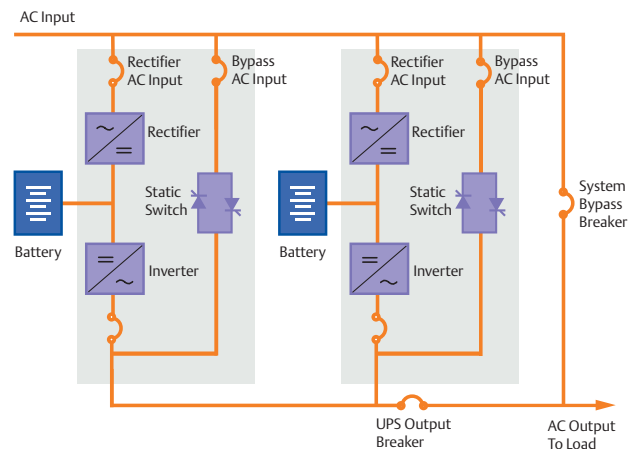

Liebert NXL N+1 Multi-Module System One-Line (500-750 kVA) Centralized Static Switch

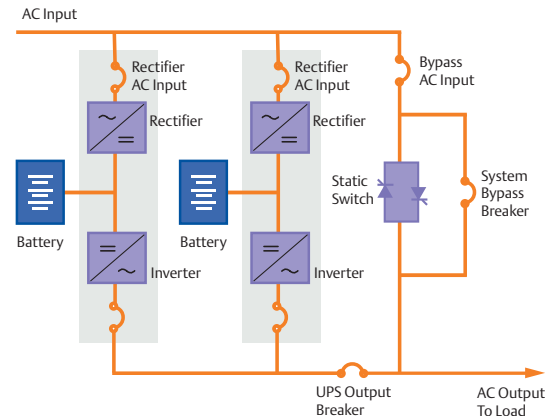

Liebert Series 610 On-Line 610 UPS: 225-1000 kVA, 3-phase

Ultimate reliability for large-scale, mission critical applications.

Offering the ultimate in power protection efficiency and reliability for larger facilities, Liebert Series 610 UPS systems are available in a wide range of capacities from 225 kVA to 1000 kVA. These systems are designed to protect mission-critical operations from the full range of power quality problems and outages.

Efficient IGBT (insulated gate bipolar transistor) technology is combined with pulse width modulation/stepwave topology to provide reliable operation and create a unit that packs more capacity into a smaller footprint.

Thanks to all-digital controls and a unique inverter topology, the Series 610 can be applied in several single-bus configurations, including single module, parallel redundant and isolated redundant systems. For added reliability, multiple units can be utilized in a dual-bus system with two power feeds to provide redundancy during normal operation, as well as continuous, shutdown-free operation when service is required.

Liebert Power Monitoring Capabilities

The operation of the Liebert Series 610 UPS can be monitored using:

- Liebert MultiLink® Automated System Shutdown Software.
- Liebert Nform™ Monitoring System.
- Liebert SiteScan® Web Centralized Monitoring System.
- Liebert Universal Monitor and Remote Power Monitor Panels.
- Third-Party Monitoring Systems.
- Liebert BDS-40 Battery Monitoring Alber Technology By Liebert.

For more information, see pages 52 and 53.

Other Features Include:

- Higher DC bus utilization provides higher AC/AC and DC/AC efficiency and allows a relatively smaller battery.
- Continuous improvement dramatically improves reliability by reducing the number of parts—and the potential points of failure within the system.
- Lower operating costs and long life thanks to 93% operating efficiency and an industry leading power factor of greater than 0.92 for all models.
- The ability to handle unbalanced and 100% non-linear loads.
- Lower heat output eliminates the need for complex air cooling arrangements.
- Robust inverter manages overloads and faults without the need for a static switch on the system output.
- Designed for intuitive, menu-driven operation, a large backlit LCD operator interface displays system controls, full-featured monitoring and alarm notifications.



Liebert NXL, Liebert Series 610 System Control Cabinet - SCC

When paralleling two or more units, a system control cabinet monitors the output of the UPS's and assures that all of the outputs are synchronized. The System Control Cabinet also contains a static bypass switch which assists in the maintenance of the system.

- System Control Cabinets are integrated into the switchgear of your choice.
- Centralized monitoring controls allow for greater visibility into the system.
- Liebert SCC's 610 contains a static bypass switch with manually operated disconnects and two motor operated system circuit breakers.
- Standard and custom power distribution switchgear systems are available for use in Tier 1 through Tier 4 UPS system configurations.

Each SCC includes:

- Microprocessor-based monitoring with backlit LCD display, controls.
- Momentary-duty static switch.
- Continuous duty static switch options with custom switchgear.
- Automatic system isolation and bypass breakers.
- Automatic equalize charge timer.
- Interface for a remote power off.
- Liebert SiteScan® Web interface.
- Alarm status contacts.
- RS-232 port.
- Visual/audible alarms.



Liebert Trinegy, Multi-Modal On-line UPS: 200 kVA - 3.2 MVA, 3-phase

The Liebert Trinegy multi-modal on-line UPS from Emerson Network Power is the only system of its kind to offer three modes of operation, providing the industry's highest levels of efficiency and reliability. It also offers the widest range of modular growth to meet future requirements — start at 400kVA and grow up to 3.2MVA.

Liebert Trinegy UPS has the highest level of flexibility, energy efficiency and adaptability of any product in its range. This transformer-free, modular, multi-modal on-line UPS supports high power data center loads with up to 99% energy efficiency depending on incoming power quality.

Liebert Trinegy Combines High Efficiency With Lower CAPEX

Liebert Trinegy UPS design features greatly minimize the total cost of ownership in every stage of installation from preparation to startup.

Installation Efficiency — The 415V structure and modular architecture of the Liebert Trinegy UPS allow for cost-effective installation, and the incremental addition of capacity as load increases, permitting the user to conserve capital until additional capacity is required thanks to lower costs for installation and materials, reduced size of electrical infrastructure and reduced cabling

Reduced Infrastructure Size And Operating Costs — The extremely high efficiency achieved with Liebert Trinegy UPS reduces the energy dissipated by the UPS (kW), thus minimizing the demand and consumption of the air conditioning system.

Circular Redundancy — The Liebert Trinegy UPS system's circular redundancy feature adjusts available UPS capacity to meet immediate load and redundancy requirements by automatically switching excess module capacity to standby, thus greatly improving efficiency at partial load and reducing operating costs.



Higher Efficiency — Means Lower OPEX

The unique architecture and technology of Liebert Trinegy UPS was developed to enhance efficiency. Able to recognize specific power quality conditions and respond appropriately to each disturbance, Liebert Trinegy UPS delivers maximum energy savings while providing the best output power quality and conditioning to the load and the source. This provides significant operating savings with up to 99% efficiency and reduced requirements for power and air conditioning.

The revolutionary architecture comes from incorporating the three industry standard functioning configurations for the first time in one high power UPS, controlled by an energy optimizing algorithm:

- **Maximum Power Control (Double Conversion/VFI)** — Provides the highest level of power conditioning and protects the load from all electrical network disturbances.
- **Maximum Energy Saving (Standby/VFD)** — Detects when conditioning is not required and allows the energy flow to pass through the bypass line.
- **High Efficiency and Power Conditioning (Line-Interactive/VI)** — Compensates the load THDi, PF and main sags and swells.

The Liebert Trinegy UPS has the ability to choose the most efficient operating mode based on different electrical conditions which ensures that the supply to the load remains optimal at all times. This allows the UPS to achieve extraordinary energy savings, first class performance and maximum power protection.



Three Dimensional Modularity

With three dimensions of modularity — Vertical, Horizontal and Orthogonal — Liebert Trinerity UPS allows businesses to expand their power protection needs at the same pace as their evolving load requirements by simply adding additional power modules. Modules can be added at anytime during the lifecycle of the UPS, allowing it to reach up to 3.2MVA .

- **Vertical modularity** — The stacked core assemblies in each core module may be individually extracted for service purposes while the UPS system continues to protect your load.
- **Horizontal modularity** — Trinerity can scale up to 400 kVA arrays by adding complete 200 kVA power modules around the input/output power section.
- **Orthogonal modularity** — The ability to work with up to 8 complete arrays in parallel — up to 3.2MVA.

Liebert Trinerity UPS

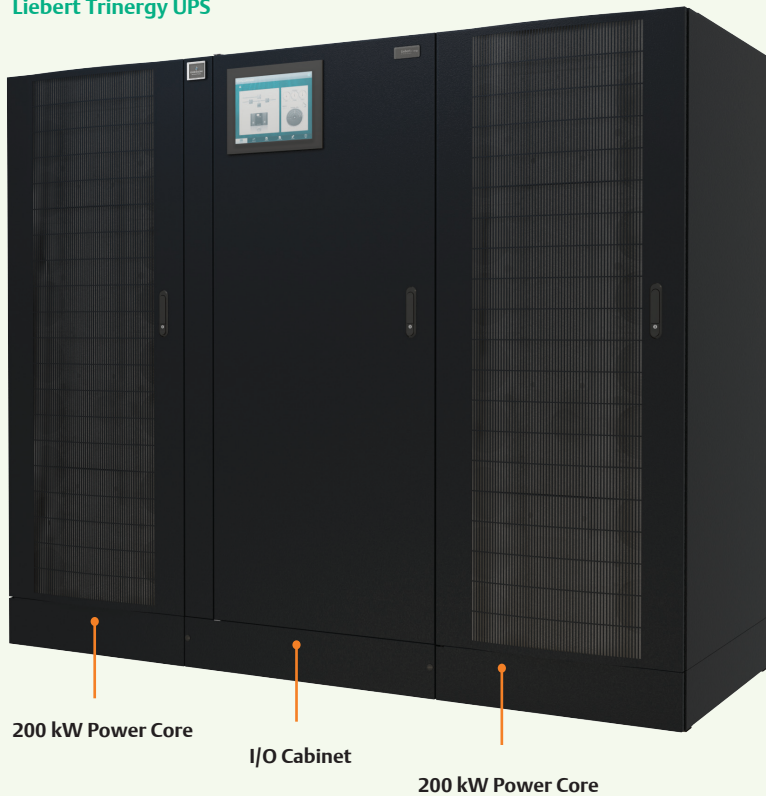

User Interface



Local monitoring of the Liebert Trinerity UPS is provided by an on-unit LCD touch screen:

- High security access with separate password levels for users and service engineers.
- User-friendly graphical interface.
- Single-line mimic diagram for system status
- Contemporary dashboard-style indicators for major system values and conditions
- Module level alerts for all major subsystems including rectifier, inverter, batteries, static switch and bypass
- System voltages and power
- Load vs. capacity indicator
- System temperature gauge
- Battery charge indicator

Liebert Power Monitoring Capabilities

The operation of the Liebert Trinerity UPS can be monitored using:

- Liebert MultiLink® Automated System Shutdown Software.
- Liebert Nform Monitoring System.
- Liebert SiteScan® Web Centralized Monitoring System.
- Liebert Universal Monitor And Remote Power Monitor Panels.
- Third-Party Monitoring Systems.
- Albér Battery Monitoring.

For more information, see pages 52 and 53.

Liebert FDC Rack Power Distribution

Power When And Where You Need It

Producing quality power is the first step—getting it to critical equipment in the most efficient manner while maintaining proper voltages and other key parameters is the important next step.

Making Sure The Power Is Always There When You Need It

Liebert's range of power distribution equipment is specially designed for high-availability applications. It includes both distribution and switching systems to provide reliable power to critical loads.

Liebert Power Distribution Solutions Are Ideal For:

- Large-Scale Computer Centers.
- Facility-Wide Networks.
- Large-Scale Telecommunications Centers
- Colocation Facilities.
- Internet Data Centers.
- Server Farms.
- Data Warehouses.
- Network Management Centers.
- Medical Imaging Equipment.
- Test and Laboratory Facilities.
- Industrial Process Control Operations.



Rack Sized Power Distribution Cabinet

As your rack-based systems grow in number, complexity and criticality—so must your power distribution system. To meet this challenge Liebert has created a product designed to optimize power distribution at the rack level with the “plug and play” flexibility that today's IT managers demand from their systems.

The Liebert FDC distribution cabinet extends the functionality of the PDU by packaging 168 poles in a stand-alone cabinet with a rack foot print.



The Standard Liebert FDC Unit Includes:

- 4 complete panelboards with main breaker (total 168 poles).
- Front and rear access only.
- Bottom cable exit.
- 22kAIC main panelboard breakers.

Optional Features Include:

- Top cable exit.
- LDM monitoring with remote communications—Modbus output.
- Isolated ground bus bars.
- EZ-view doors enable visual inspection of the breakers without unlocking the cabinet.
- Square D or GE inline panelboards in bolt-in or plug-in styles.
- Current monitoring panel.
- Tie-breakers to allow connection of two panelboards to a common panelboard main breaker (requires side access).
- Plug-in main panelboard breakers.

Liebert RDC Remote Distribution Cabinet

The Better Way To Wire High Density Facilities

The influx of client/server rack equipment is changing the content of data centers. There are more devices than before—and they consume less power than their predecessors. As a result, most power distribution units (PDUs) run out of circuit breaker poles before they run out of rated capacity.

The Liebert Remote Distribution Cabinet (RDC) extends the functionality of the PDU by packaging 168 poles (four complete 42-pole inline panelboards) in a stand-alone cabinet.

Unlike standard Liebert Precision Power Centers (PPCs), the RDC has no internal isolation transformer and requires 4-wire-plus-ground input from a PPC or other transformer. By separating the PPC transformer from the panelboard function, Liebert was able to create an extremely compact package that fits the area of a standard 24" x 24" raised-floor tile.

The individual panelboards inside the Liebert Remote Distribution Cabinet can receive power from different sources. This enables the RDC to provide fault-tolerant, fully maintainable dual-bus power to nearby load equipment. A dual-input RDC can be configured with two panelboards on each side sharing common input terminals.

Other Features Of The Liebert RDC:

- Unobstructed wiring access for easy of installation.
- Complete isolation and maintainability.
- Optional clear door insert panels enabling visual inspection of the breakers without unlocking the cabinet.
- Optional adjustable accent panels to make it easier to compensate for breaker “creep”.
- Single, dual or four-input configurations.
- Optional current monitoring panel.
- Optional input junction box and underfloor conduit box.
- UL labeled.

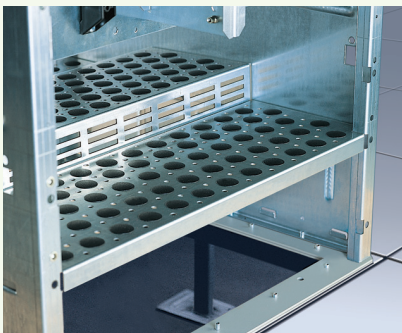

Conduit-landing plate, left, is positioned for easy cable access.



Liebert Power Monitoring Capabilities

The operation of the Liebert FDC and Liebert RDC can be monitored using:

- Liebert SiteScan® Web Centralized Monitoring System.

For more information, see pages 52 and 53.

Liebert FPC Rack-sized Power Conditioning and Distribution Cabinet

Optimized For Row-based Applications.

The Liebert FPC power conditioning and distribution cabinet provides higher quality, more flexible power distribution for high-density data centers. It is engineered to combine the convenience and cost savings of a pre-packaged, factory-tested unit with the flexibility of a custom-tailored power system. This self-contained system provides power isolation, power distribution, computer-grade grounding and power monitoring.

Ranging in capacity from 15kVA up to 300kVA, the Liebert FPC comes in a 19" rack and 47" wide rack, the size of two 19" racks, and is designed to fit at the end of, or within, a row of racks, as well as in a stand-alone configuration.

The packaged system approach of the Liebert FPC is convenient and space-saving, reducing installation time and cost compared to a conventional approach using multiple interconnected components.

Other Standard Features Of The Liebert FPC:

- Computer-grade grounding.
- Fully compatible with the non-linear loads.
- Main input breaker with shunt trip.
- Double-shielded TP1 listed isolation transformer.*
- One or more individually enclosed 42-pole output panelboards.
- Built-in metering and alarm annunciation with communication to Liebert centralized monitoring.
- Compact single cabinet conserves valuable floor space.
- Single input cable connection reduces installation time and cost.
- Full front and rear access.
- Can be easily relocated to protect your investment.
- UL and ULc Listed as a complete system.

*Energy Policy Act of 2005 requires that all "distribution transformers" and all "low-voltage dry-type distribution transformer" manufacturers produce only TP-1 units as of January 1, 2007. TP-1 transformers have a higher efficiency than standard isolation transformers, and are optimized to have the highest efficiency at 35% load.



Liebert PPC Packaged Power Conditioning and Distribution

Optimized For Room-Based Applications.

Liebert Precision Power Center

The Liebert Precision Power Center (PPC) power conditioning and distribution cabinet is designed to bring you a distribution system that offers the benefits of a custom-tailored power system, with the convenience and cost savings of a pre-packaged, factory-tested unit. Housed in a single, self-contained cabinet, it combines distribution, computer-grade grounding, isolation, and power monitoring to provide the protection your vital computer or communications equipment demands. Available in 15-800 kVA capacity systems for raised floor applications and 15-150 kVA capacities in top-exit models for non-raised floors, the Liebert PPC offers flexible expansion capabilities to fit growing sites.

The packaged system concept of the Liebert PPC is convenient and space-saving, reducing installation time and cost compared to a conventional approach using multiple interconnected components.

Other Standard Features Of The Liebert PPC:

- Secure distribution and circuit identification.
- Non-linear load compatibility.
- Individual circuit breaker protection.
- Built-in metering and alarm annunciation, with communication to Liebert-centralized monitoring systems.
- Double-shielded TP-1 listed isolation transformer.*
- Easy installation, with single input cable connection and application matched connections to the load.
- Expandable with add-on panelboards and flexible cabling.
- Flexibility to protect your investment by allowing the unit to be easily relocated.
- UL and CSA Listed as a complete system.

*Energy Policy Act of 2005 requires that all “distribution transformers” and all “low-voltage dry-type distribution transformer” manufacturers produce only TP-1 units as of January 1, 2007. TP-1 transformers have a higher efficiency than standard isolation transformers, and are optimized to have the highest efficiency at 35% load.



Liebert Power Monitoring Capabilities

The operation of the Liebert Precision Power Center and Liebert FPC can be monitored using:

- Liebert Nform™ Monitoring System.
- Liebert SiteScan® Web Centralized Monitoring System.
- Third-Party Monitoring Systems.

For more information, see pages 52 and 53.



Easy-To-Use Color Touch-Screen Interface
The controls of the Liebert STS2 are intuitive and simple. The pop-up menus are easy to understand and provide a wealth of operational and diagnostic information.

The color LCD monitor is divided into three segments. In addition to a system mimic diagram, there is a status/ alarm panel and a section dedicated to operator instructions and menus. You benefit from improved operator effectiveness, reduced training time, and less chance of operator error.

Liebert STS2 Static Transfer Switch

The Key To High-Availability Power.

The Liebert STS2 Static Transfer Switch provides an automatic, seamless transfer between the outputs of two independent UPS systems and the input of a critical load in a dual-bus power system. If the primary UPS should fail, the switch will automatically transfer the loads to the surviving UPS. For redundancy, the Liebert STS2 features three separate, self-correcting logic modules. Each controller is capable of working independently and each helps monitor the other two. Available in capacities ranging from 100 up to 1000 amps.

True Front-Access Design

All mechanical and electronic components of the Liebert STS2 are accessible from the front of the unit. This gives you several immediate benefits:

- Greater freedom in system design. The Liebert STS2 can be placed adjacent to or in back of other equipment. It can also be placed against a wall or partition.
- Simplified installation, with ample space for cable connections through top and bottom access plates.
- Less floor space required for maintenance access.
- Simplified maintenance, with all key components visible, serviceable and removable from the front of the unit, without the need to shut down the connected load.

Other Features Of The Liebert STS2:

- Internal CANBUS protocol provides high-bandwidth communication between system components via twisted-pair cables. Options can be added as simple network nodes.
- Internal dual-bus control power.
- Simplified installation and maintenance.
- Full range of communications options to fit any monitoring strategy.
- Three-pole switch configurations.
- Optimized Transfer option uses the patented Liebert static transfer control algorithm to eliminate downstream transformer inrush saturation. Meets CBEMA and ITIC standard for critical loads.



True Internal Redundancy

The Liebert STS2 has triple-redundant logic. Each DSP controller is capable of working independently, and each helps monitor the other two. If one malfunctions, the other two lock it out. Each controller has power feeds from both power supplies.

The two power supplies feature true dual-bus power distribution. Both have dual inputs, one from each AC input source. All power connections have diode protection, so that internal or external faults cannot propagate. The result is a rugged, fault-resilient package that is optimized for real-world applications.

Liebert STS2/PDU Static Transfer Switch/ Power Distribution Unit

Combines Power Distribution And Automatic Switching.

With a single, space-saving unit, the Liebert STS2 Static Transfer Switch/Power Distribution Unit combines the switching capabilities of the STS2 with the benefits of a proven power distribution unit.

Liebert designed the STS2/PDU to bring you a distribution system that will close the power delivery loop in your critical facility. It offers the benefits of a custom-tailored power system, with the convenience and cost savings of a pre-packaged, factory-tested unit.

Housed in a single, self-contained cabinet, it combines distribution, computer-grade grounding, isolation, and power monitoring, as well as dual-source switching, to provide the protection your vital computer or communications equipment demands.

Available in capacities from 250 to 800 amps, the Liebert STS2/PDU offers flexible expansion capabilities to fit growing sites. The packaged system approach of the Liebert STS2/PDU is convenient and space-saving, reducing installation time and cost compared to a conventional approach using multiple interconnected components.



Features Of The Liebert STS2/PDU Include:

- True dual-bus power distribution switches automatically or manually between two AC power sources.
- Computer-grade grounding automatically establishes a single point ground to meet major manufacturers' recommendations and the requirements of the National Electric Code.
- Fully compatible with the non-linear loads of modern computer systems and other electronic equipment.
- Built-in metering and alarm annunciation with communication to Liebert SiteScan® Web centralized monitoring.
- Compact single cabinet conserves valuable floorspace compared to non-packaged solutions.
- Single cabinet design reduces installation time and cost.
- The unit can be easily relocated to protect your investment.
- UL Listed as a Complete System to meet safety requirements for fast, hassle-free inspection and building code approvals.
- A choice of distribution options to fit site requirements.

Liebert Power Monitoring Capabilities

The operation of the Liebert STS2 and Liebert STS2/PDU can be monitored using:

- Liebert Nform™ Monitoring System.
- Liebert SiteScan® Web Centralized Monitoring System.
- Liebert Universal Monitor and Remote Power Monitor Panels.
- Third-Party Monitoring Systems.

For more information, see pages 52 and 53.

Liebert Power Systems Test Center

The Liebert Power Test Center for large UPS systems is a state-of-the-art test facility designed to provide customers with pre-installation testing of the performance, interoperability, and efficiency of Liebert power modules and systems under a variety of conditions. Located in Delaware, Ohio, the 41,000 square-foot facility, including a 2,600 square-foot customer observation suite, is the largest and most comprehensive in the industry.

Testing includes individual UPS modules as well as the complete power system—including large UPS units such as the Liebert NXL UPS and associated switchgear and ancillary products—and is essential to the smooth, rapid installation and commissioning of large power systems. Customers leave the Liebert Power Test Center with documented test results and confidence that their complex power system will operate seamlessly and in accordance with business-critical availability requirements.

Test Capacity and Performance of Liebert Power Solutions

The Liebert Power Test Center for large UPS systems consists of multiple test stations in each of seven test bays. Testing is customized based on the complexity, size and number of UPS components in the configuration, but always includes analysis of every module as well as the entire system. Module and system tests include:

- Steady-state — 0% to 100% plus overload, unbalanced loading; non-linear loading
- Dynamic — 0% to 100% step loads plus overload, unbalanced loading; non-linear loading
- Overload and faults — (>100%, 125%, 150%)
- Plus other customer-specified special test requirements.

Testing on large Liebert UPS systems, may include UPS power modules, input and output switchgear, power distribution units, static transfer switches, and battery cabinets.

Test results certify the input and output, AC and DC characteristics of the system. Performance comparisons against specifications include, but are not limited to:

- Voltage and waveform
- Voltage regulation
- Voltage and current harmonics
- Frequency
- Current and waveform
- I/O power factor
- Efficiency based on kW in and out
- System switching, control and monitoring functionality





Factory Witness Testing: View the Entire Testing Process

Factory Witness testing for large UPS systems is usually conducted over a period of multiple days. During testing, customers and consulting engineers may oversee the entire process from the Power Test Center observation suite that overlooks the test bays or in the specific test bay itself. Multiple LCD panels offer easy access to real-time test data, including waveforms, testing procedures and results. Once testing is completed, a report of the results is provided.

The Liebert Power Test Center features seven test bays, each containing multiple test stations, where module and complete system analysis is conducted in full view of the customer.

Liebert Power Test Center Features:

- Seven test bays, each containing multiple distinct test stations.
- Power test viewing suite overlooking test bays and equipped with LCD panel displays that offer easy access to relevant test data.
- Results are provided at the conclusion of each test.
- All I/O circuit breakers can be remotely controlled.
- Voltage, current, frequency and watts monitored on all I/O circuit breakers.
- Total power of >12 MW available via the facility utilities.
- Higher capacities supported through a 1.75 MVA, 750 kVA, and 350 kVA 50/60 Hz engine generator as well as plug-ins for additional generators.

Benefits of Power System Testing:

- Provides complete pre-installation testing of large UPS systems and associated support equipment.
- Tests the performance, interoperability and efficiency of critical power systems.
- Assures rapid installation and commissioning of large UPS power systems.
- Confirms the functionality of all subsystems.
- Allows customers to document performance of multi-module UPS systems prior to installation.
- Optimizes the testing process with the use of the latest agency standards.

Power Quality Solutions

For applications requiring protection from electrical line problems without the need for back-up capability, Liebert manufactures a full line of surge suppression and power conditioning equipment.

The Best Possible Power

Liebert's wide range of Surge Protective Devices, (SPDs) have numerous applications throughout a facility, including protection against transients that are generated by other equipment within the building. Our power conditioning systems shield critical loads from external disturbances, particularly those coming through the utility power line.

Liebert Power Protection Solutions Are Ideal For:

- Computer Centers.
- Facility-Wide Networks.
- Telecommunications Centers.
- Colocation Facilities.
- Internet Data Centers.
- Network Management Centers.
- Medical Imaging Equipment.
- Test And Laboratory Facilities.
- Industrial Operations.



High Quality Surge Protection

These Products Include:

High Exposure Systems



Liebert SI Series (Interceptor II)—Built to provide the highest level of surge current capacity, with the lowest clamping voltages. Along with true NEMA 4 assembly suitable for outdoor use.



Liebert LM Series—Offers continuous protection from damaging transients and electrical line noise. Surge suppression levels range from 120 kA to 500 kA per phase.



Liebert ACV Series (AccuVar)—A full line of multi-phase, multi-mode distribution panel-mounted surge suppression devices.



Liebert SH Series (Hybrid) - Liebert SH Series (Hybrid) is the first hybrid product in the industry to offer a true coordinated multi-stage system of suppression. Integrating the fast response time of the SAD (Silicon Avalanche Diode) module with the high-energy capability of the standard Liebert Interceptor MOV (Metal Oxide Varistor) modules. Surge current capacity ranges from 250 kA to 750 kA per phase.



Liebert ATF Series (Active Tracking Filter™)—A customized, modular approach to surge protection in a series filter device.



Liebert SS Series—Approved by Motorola R56 Committee, Standards and Guidelines for Communication Sites—Type 1 and 2 Devices. Utilizes advanced SAD/MOV array technology for industry leading transient suppression voltages.



Liebert LPGE Series—An add-on device for integration with panelboards at the jobsite for enhanced surge suppression. Surge current capacity levels range from 130 kA to 200 kA per phase.

Emerson Network Power manufactures the industry's widest range of Surge Protective Devices (SPDs). These SPDs are ideal for small facilities, large equipment rooms or entire buildings, plus a wide range of power, control and data line applications. Each surge protection product features the rugged reliability that has been the Liebert trademark for more than 40 years.

Installing protection at the electrical service entrance, distribution points, branch panelboards and on specific sensitive loads or equipment throughout your facility is the best way to prevent damage and eliminate associated downtime to sensitive microprocessor-based electronics.

Home and Office Protection



Islatrol™ SP-6TVN Series—The Islatrol SP-6TVN is a surge suppressor/filtering device that features uniquely designed repositionable outlets and protects sensitive home/office equipment including home theaters, satellite dishes, computers, printers and faxes.

Medium & Low Exposure Systems



PowerSure LPL & LPM Series—surge suppression systems protect connected equipment against electric power line disturbances and transients in medium and low exposure locations. Displays LED status indication. Provides remote indication capabilities.

Islatrol™ RM Series—This line of AC surge protectors is ideal for protecting the power feeding valuable rack equipment. This series provides 40,000 Amps of surge protection and up to 60 dB of high-frequency noise filtering.

Data/Signal Line Protection



Edco RM-CAT6 Series—Includes 16 and 48-channel high-speed data line protectors that utilize three-stage hybrid technology. These units address high-energy voltage transients that can damage expensive network equipment. Ideal for network patch panels, switches and hubs, these units mount easily in the same racks as the equipment they are protecting.



Edco PC642 Series—The Edco PC642 Series surge suppressor is a two-pair (four-wire) module implementing three-stage hybrid technology. This module addresses over-voltage transients with gas tubes and silicon avalanche components.



Edco LCDP Series—The Edco LCDP Series is designed to conveniently protect 8 wire, low voltage data circuits and employs two RJ-45 jacks for easy installation.



Edco RJA-RJD Series—The Edco RJA and Edco RJD Series are four pair telephone/data line protectors that implement advanced two stage hybrid design.



Edco CAT6-5 POE Series—The Edco CAT6-POE Series is designed to work on Category 5 Power-Over-Ethernet transmission lines as well as CAT 6 applications.



Edco PHC Series—This surge suppressor is designed to protect two pairs of wires specifically for alarm and security systems where operating currents can be as high as 5 Amps. It utilizes three-stage hybrid technology to address overvoltage transients and sneak and fault current for signaling circuits.

Powerful Solutions For Critical Data And Telecom Applications

From major switching and data centers to remote shelters and computer rooms, Emerson Network Power -48V DC power systems have the features and proven performance to match your network application needs.

Visit: EmersonNetworkPower.com/DCPower

NetSure® ITM Features

- **High system efficiency:** Reduced end-to-end power conversion stages combined with efficient power conversion units (PCUs) and an advanced energy optimization mode enable significant energy savings even at low loads.
- **Scalability and ease of deployment:** Minimize your initial investment and avoid stranded power by adding expansion DC UPS modules without interruption in the field as power needs increase.
- **DC architecture simplicity:** Fewer components, conversion stages and distribution breakers throughout the power chain ensure high availability; elimination of complex synchronization circuits and the need to de-rate capacity for phase balancing or harmonics makes it easy to engineer.
- **Energy Optimization Mode**
Intelligent Power Matching
Achieves near-peak UPS efficiency down to 5% system load by optimizing individual PCU performance, greatly reducing energy costs over time in real world conditions

DC UPS

400/480V AC 3-Phase Input

Integrates AC to DC power conversion, battery backup and branch distribution into a compact, highly reliable power protection system for data center applications.

NetSure® ITM

The NetSure® ITM lowers the cost of data center design, operation and management. This 48V direct current solution is a row-based DC UPS that delivers simple, scalable and highly efficient power protection in 70kW modules. Up to four DC UPS modules can be installed together for 280kW of total power.

The NetSure® ITM is deployed directly on the server room floor, providing protected 48V power to nearby equipment racks. This preserves the efficiency and reliability benefits of DC power, minimizes the amount of copper required, and enables modular growth.



NetSure® ITM 140kW, Two Module System

NetSure® rectifiers or power conversion units (PCUs) convert 3 phase 400/480V AC to -48V DC and are the heart of the NetSure® ITM. Each DC UPS module includes twelve independent 5.8kW PCUs. Each DC UPS module is factory integrated with distribution and battery backup. 48V branch distribution via 22 circuit breakers (6 fuses optional); 5-10 minutes of battery backup is provided across three parallel 48V battery strings.

48V DC Rack Power Distribution

NetSure® RDB Series

Deploy DC power in your rack with zero U, rear mount power distribution units (PDUs) to maximize rack space available for revenue generating equipment. Featuring plug-and-play connectors for simple field operation, NetSure® RDB 48V Rack Distribution Units are designed for ultimate ease of use.

With a maximum load capacity of 8.4 kW for each PDU and various output breaker sizes available, the NetSure® RDB Series is provisioned to optimize the wire size required to each device. This allows for easy pre-configuration and management as no special tools are required to maintain or move IT equipment.

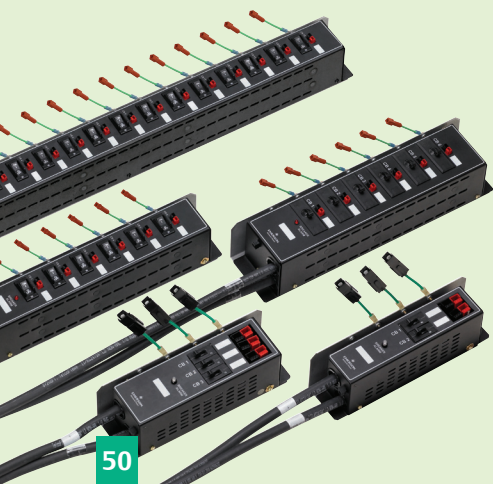

As the next step in the evolution of the NetSure® DC Power platform, eSure™ high-efficiency rectifiers from Emerson offer superior performance and uncompromised reliability, delivering efficiency levels near 97%. eSure™ technology delivers Efficiency Without Compromise™.



Large DC Power Systems 208/480VAC 3-Phase Input

Power systems for data center and central office applications, including wireline and wireless switching, transmission, data routing and large telecom hotels.



NetSure® 801
The NetSure® 801 high-density power system offers the increased flexibility of a cabled plant in a centralized or distributed architecture.



NetSure® 802
Integrated -48VDC 3-phase rectifiers, distribution, control and monitoring in a single frame. Expandable to 10,000 amps with additional frames.

Medium DC Power Systems 240VAC Single Phase Input

Modular, flexible design for switching, wireless base stations, transmission, LAN, WAN and other networking operations.



NetSure® 700
The NetSure® 700 power system with 2500 watt or 3000 watt rectifiers and 1500 watt converters is a modular power system providing up to 4,000 amps of power at +24VDC and 400 amps at -48VDC.



NetSure® 701
Modular power system providing up to 4,000 amps of power at -48VDC with 3200 watt standard or high-efficiency eSure™ rectifiers.

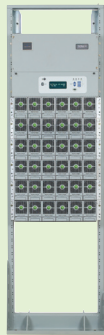

NetSure® 702
Combines the advantages of the smaller 3200 watt standard and high-efficiency eSure™ rectifiers from the NetSure® 701 system with the controller capability and plant architecture of the NetSure® 801 system.

Small DC Power Systems 120 / 240VAC Single Phase Input

Highly reliable, uninterruptible and cost-effective power systems for small data or telecom installations.

NetSure® 502

The NetSure® 502 is a flexible system capable of providing DC power through the use of 2000W standard or high-efficiency eSure™ rectifiers, an SCU+ controller, and a variety of output distribution options.



Mini DC Power Systems 120 VAC or 220/240VAC Single Feed Input

High-density mini-sized DC power solutions for outside plant enclosure, central office or embedded applications.

NetSure® 211

This DC power solution offers 1RU and 2RU configurations, combining reliable NetSure® rectifiers with an advanced Ethernet-accessible controller for mini power applications.



DC Power Distribution Equipment

Custom designed or standard enclosures available for all types of data and telecom equipment.



LORAIN® DB 48500
This modular system provides effective secondary load distribution for single or multiple -48VDC feeds.

NetSure® 801 DB

Battery Distribution Fuse/Circuit Breaker Bay featuring high capacity, front access, modularity, and simplified installation to effectively provide secondary load distribution and protection for multiple -48 VDC feeds up to 600 amps.



DC to AC Inverter Systems 120VAC and 230 VAC Single Phase Output

Ideal for a data center, wireless switching, or central office environment where flexible expansion capabilities are required.

Enclosure Solutions

Custom designed or standard enclosures available for all types of data and telecom equipment.

Batteries & Accessories

Products frequently used together with DC power systems including batteries, battery strands, battery trays, bus covers, assorted panels, circuit breakers and much more.

Power System Monitoring: The Key To Continuous Operation

What You Don't Know Can Hurt You.

A small problem in a critical facility can quickly escalate into a disaster—knowing what is happening with your power equipment, so you can keep that protective “envelope” at peak operating efficiency, is vital to system reliability.

Different People Need To Know Different Things.

Liebert offers you more monitoring solutions than anyone else because getting the right information about your power equipment to the right people, with the right level of urgency, is so important to system availability.

We do this by allowing you to receive and use information from your Liebert power equipment's microprocessor controls—no matter where it is located or what communications protocol, operating platform or building management system is being used. In-band, out-of-band and web-based monitoring are all available. From enterprise monitoring systems to individual pieces of communications hardware, you will know the exact problem so that you can implement the right solution.

How Deep Does Your Monitoring Need To Be?

Monitoring can range from a automated shutdown software that provides basic operating information from a single UPS unit, all the way to full-scale monitoring and control of a critical facility including trending and data analysis.

Your requirements will vary according to the specificity of the information you need. You may require no more than a local readout of a unit's operating status. Or you may need the ability to control its operation and receive alarms.

These information requirements may also go beyond basic monitoring and control. You may need the ability to analyze performance data in order to pinpoint trouble spots so that the same problems don't happen again and again.



Maximizing Your Investment Through System Monitoring

Distributed Management with Liebert IntelliSlot Interface Cards

For enhanced remote communications and control of your Liebert units, the Liebert IntelliSlot Web and 485 Cards deliver the communication capabilities you require.

Monitoring and control through your existing Network with no additional software required.

Each Liebert system equipped with a Liebert IntelliSlot Web Card takes full advantage of your Ethernet network, allowing remote monitoring from your computer desktop, network operations center or wherever network access is permitted, without the need for front-end software.

Monitoring integration with your existing Building Management System.

A Liebert system equipped with a Liebert IntelliSlot™ 485 Card can be seamlessly integrated with your existing Building Management System.

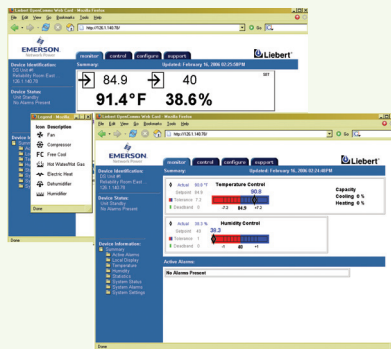

Liebert IntelliSlot Web

Centralized Management with Liebert Nform® Software

As business grows, your critical equipment infrastructure will expand, thus the need for centralized management of this equipment will be key to your business success.

Connecting to equipment in the distributed critical space is only part of the monitoring challenge.

Liebert Nform leverages the network connectivity capabilities of your Liebert equipment to provide a centralized monitoring view of your distributed equipment.

Utilizing the SNMP and Web technologies built into each of the Liebert IntelliSlot communication cards, Liebert Nform will centrally manage alarm notifications to provide you with an easy interface to access critical status information. Liebert Nform puts critical systems information at the fingertips of support personnel—wherever they are—increasing responsiveness to alarm-event conditions, thus allowing IT organizations to maximize their system availability.

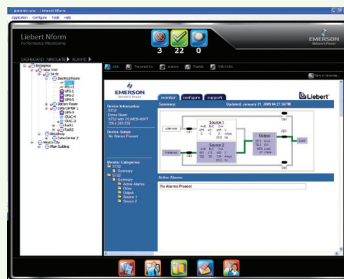

Liebert Nform

Enterprise Management with Liebert SiteScan® Web Software

For customers who require extensive management of critical system equipment that may span multiple locations in an ever-moving global enterprise, Liebert SiteScan Web will centrally manage your critical equipment and give you the power to move beyond the event-responsive service paradigm.

Liebert SiteScan Web does it all:

- Real-Time Monitoring and Control.
- Event Management and Reporting.
- Data Analysis and Trending.
- Building Management Integration.

Liebert SiteScan Web is a comprehensive critical systems management solution dedicated to ensuring reliability through graphics, event management and data extrapolation. The standard Web interface allows users easy access from anywhere at anytime.

- Single and multi-site applications.
- Event management and unit control.
- Trend and historical data captures and reporting.
- Full ASHRAE BACnet compatibility.
- Java based.
- Windows 2000, XP and 2003 compatible.

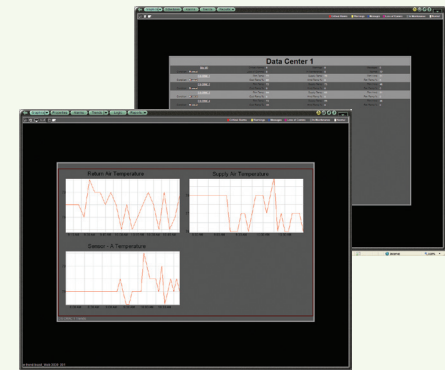

Liebert SiteScan Web

Liebert Services

Complete Start-Up And Preventive Maintenance Services

Peace of mind. It's confidence you've done everything possible to assure system uptime. It's confidence the power systems you rely on are operating at peak performance. It's confidence you've selected the best partner available to bring you back online in the event of unexpected downtime.

Complete confidence. When it comes to selecting a service organization to maintain your critical power systems, you can only have complete confidence that Emerson Network Power Liebert Services can deliver:

- **Real uptime assurance.** We have the proprietary tools, industry knowledge and robust service infrastructure to deliver real assurance that your systems will be available when you need them.
- **Efficient downtime recovery.** After all, if downtime strikes, you need a partner that can get you back online quickly with intelligent answers, rapid service response and parts where and when you need them.

Confident Customers. Satisfied Customers.

You know them. They're confident because they know their systems will be available when they need them. So, they're satisfied customers—and, they're probably ours. 99% of our customers are satisfied with the service we provide. In fact, 96% of them would recommend us to someone else (source: MRSI).

Proprietary Tools Deliver Uptime

Ensuring peak operating performance of your equipment comes down to having knowledgeable Field Technicians in your facility with the most current tools available to do the job. Only Emerson Network Power Field Technicians have access to the proprietary tools needed to ensure system uptime—firmware upgrades, factory engineering specifications, access to Liebert product and application engineers and R&D. No one else can bring this to your organization.

The Business Case For Regular Maintenance

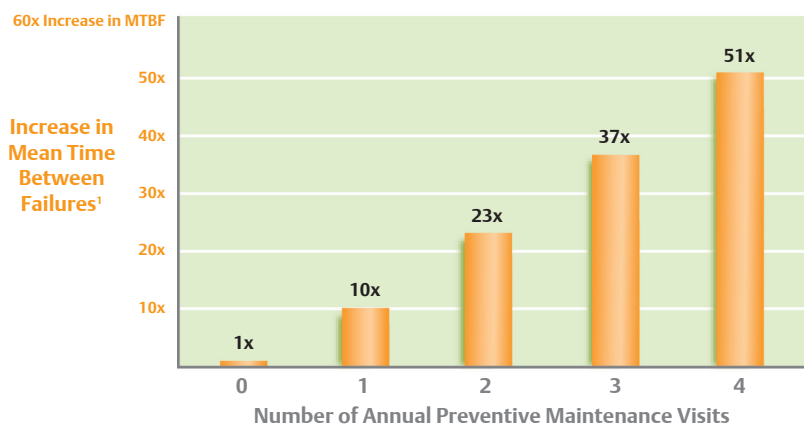

Regular OEM preventive maintenance increases the mean time between failures (MTBF).

For instance, the mean time between failures for a system that receives 1 annual PM is 10 times greater than a system that receives 0 PMs.

By contrast, a system that receives 4 annual PMs, as opposed to 0 PMs, increases its duration between failures by 51 times.

¹ Data is based on Mean Time Between Failure analysis for three phase UPS systems ($\geq 100\text{kVA}$) with an Emerson Network Power service agreement between 2002-2007.

Servicing All Your Critical Power Equipment

Your investment in power equipment is worthless if you don't maintain it. Not even the best equipment can function properly unless it's serviced with a regular maintenance schedule.

Emerson Network Power services the complete spectrum of UPS, batteries and related power distribution equipment in your data center or in other critical facilities where continuous availability of systems is essential.

The Power Equipment We Service Includes:

- All UPS and Batteries.
- Automatic Transfer Switch.
- Static Transfer Switch.
- System Control Cabinets.
- PDUs.
- Bypass Cabinets.
- Power Conditioning & Distribution.



Emerson Network Power's Liebert Services Business

Your power equipment functions as a complete system. Shouldn't your service provider? Only Emerson Network Power has the expertise and experience to service your entire power infrastructure and all its components—from utility to rack.

Generator Automatic Transfer Switch TVSS SwitchGear UPS Batteries Static Transfer Switch Remote Distribution Cabinet

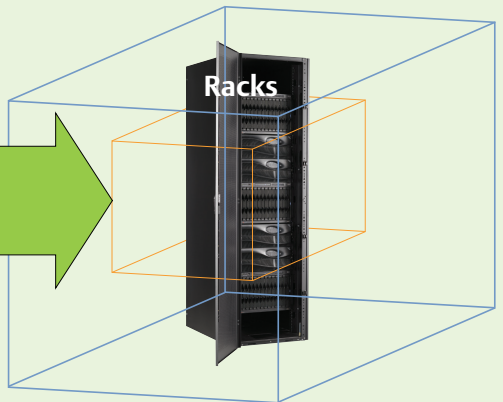

Power Availability

Availability depends on the continuity of power and the ability of an uninterruptible electrical supply to ride through outages of any duration.

Power Protection

Raw utility power may be unsuitable for sensitive technology systems. In these situations, surge suppression and power conditioning can deliver the power quality you need.

Power Conversion/Distribution

Converting and delivering power throughout a large facility or a small space is an important step in protecting availability.

Ensuring The High Availability Of Mission-Critical Data And Applications.

Emerson Network Power, a business of Emerson (NYSE:EMR), is the global leader in enabling *Business-Critical Continuity*™ from grid to chip for telecommunication networks, data centers, health care and industrial facilities. Emerson Network Power provides innovative solutions and expertise in areas including AC and DC power and precision cooling systems, embedded computing and power, integrated racks and enclosures, power switching and controls, monitoring, and connectivity. All solutions are supported globally by local Emerson Network Power service technicians. Liebert AC power, precision cooling and monitoring products and services from Emerson Network Power deliver *Efficiency Without Compromise*™ by helping customers optimize their data center infrastructure to reduce costs and deliver high availability.

Emerson Network Power

Liebert Corporation
World Headquarters
1050 Dearborn Drive
P.O. Box 29186
Columbus, Ohio 43229
United States Of America
800 877 9222 Phone (U.S. & Canada Only)
614 888 0246 Phone (Outside U.S.)
614 841 6022 FAX

Emerson Network Power
European Headquarters
Via Leonardo Da Vinci 8
Zona Industriale Tognana
35028 Piove Di Sacco (PD)
Italy
39 049 9719 111 Phone
39 049 5841 257 FAX

Emerson Network Power Asia Pacific
29/F, The Orient Square Building
F. Ortigas Jr. Road, Ortigas Center
Pasig City 1605
Philippines
+63 2 687 6615
+63 2 730 9572 FAX

liebert.com

24 x 7 Tech Support

800 222 5877 Phone
614 841 6755 (outside U.S.)

While every precaution has been taken to ensure accuracy and completeness in this literature, Liebert Corporation assumes no responsibility, and disclaims all liability for damages resulting from use of this information or for any errors or omissions.

© 2011 Liebert Corporation. All rights reserved throughout the world. Specifications subject to change without notice.

All names referred to are trademarks or registered trademarks of their respective owners.

® Liebert is a registered trademark of the Liebert Corporation.

SL-70100 (R06/11) Printed in USA

EmersonNetworkPower.com

Emerson Network Power.

The global leader in enabling *Business-Critical Continuity*™.

- | | | | |
|----------------|----------------------|------------------------------|-------------------------------|
| ■ AC Power | ■ Embedded Computing | ■ Outside Plant | ■ Racks & Integrated Cabinets |
| ■ Connectivity | ■ Embedded Power | ■ Power Switching & Controls | ■ Services |
| ■ DC Power | ■ Monitoring | ■ Precision Cooling | ■ Surge Protection |