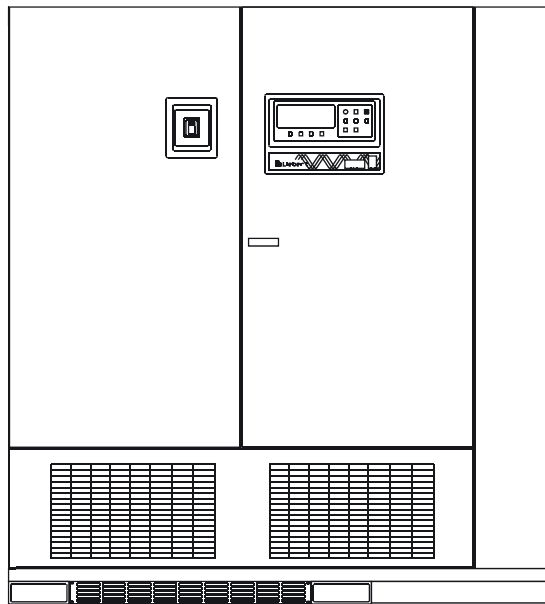


# Liebert Series 610™ UPS

Installation Manual - 300-450kVA, 60Hz, Three Phase Single-Module



## BATTERY CABINET PRECAUTIONS

---

The following warning applies to all battery cabinets supplied with UPS systems. Additional warnings and cautions applicable to battery cabinets may be found in:

- **Important Safety Instructions**—page 1
- **Section 2.0 - Unloading and Handling**
- **Section 5.0 - Battery Installation**



### WARNING

Internal battery strapping must be verified by manufacturer prior to moving a battery cabinet (after initial installation).

- Battery cabinets contain non-spillable batteries.
- Keep units upright.
- Do not stack.
- Do not tilt.

Failure to heed this warning could result in smoke, fire or electric hazard.

Call 1-800-LIEBERT prior to moving battery cabinets (after initial installation).

## CONTACTING LIEBERT FOR SUPPORT

---

To contact Liebert Global Services for information or repair service in the United States, call 1-800-LIEBERT (1-800-543-2378). Liebert Global Services offers a complete range of start-up services, repair services, preventive maintenance plans and service contracts.

For repair or maintenance service outside the 48 contiguous United States, contact Liebert Global Services, if available in your area. For areas not covered by Liebert Global Services, the authorized distributor is responsible for providing qualified, factory-authorized service.

For LGS to assist you promptly, please have the following information available:

Part numbers: \_\_\_\_\_

Serial numbers: \_\_\_\_\_

Rating: \_\_\_\_\_

Date purchased: \_\_\_\_\_

Date installed: \_\_\_\_\_

Location: \_\_\_\_\_

Input voltage/frequency: \_\_\_\_\_

Output voltage/frequency: \_\_\_\_\_

Battery reserve time: \_\_\_\_\_

---

# TABLE OF CONTENTS

<b>BATTERY CABINET PRECAUTIONS</b> .....	<b>INSIDE FRONT COVER</b>
<b>CONTACTING LIEBERT FOR SUPPORT</b> .....	<b>INSIDE FRONT COVER</b>
<b>IMPORTANT SAFETY INSTRUCTIONS</b> .....	<b>1</b>
<b>1.0 INSTALLATION CONSIDERATIONS</b> .....	<b>3</b>
<b>2.0 UNLOADING AND HANDLING</b> .....	<b>5</b>
<b>3.0 INSPECTIONS</b> .....	<b>6</b>
3.1 External Inspections .....	6
3.2 Internal Inspections .....	6
<b>4.0 EQUIPMENT LOCATION</b> .....	<b>7</b>
<b>5.0 BATTERY INSTALLATION</b> .....	<b>8</b>
5.1 Battery Safety Precautions .....	8
5.2 Battery Safety Precautions in French Per CSA Requirements .....	9
5.3 Battery Cabinets .....	10
5.4 Open-Rack Batteries .....	11
<b>6.0 OPTIONAL TRANSFORMER CABINET</b> .....	<b>12</b>
<b>7.0 CONFIGURING YOUR NEUTRAL AND GROUND CONNECTIONS</b> .....	<b>13</b>
7.1 Preferred Grounding Configuration, Wye-Connected Service .....	14
7.2 Alternate Grounding Configuration, Wye-Connected Service .....	15
7.3 Preferred Grounding Configuration With Isolated Bypass .....	16
7.4 Alternate Grounding Configuration, Non-Isolated .....	17
7.5 Grounding Configuration, Corner-Grounded Delta or Impedance-Grounded Wye .....	18
7.6 Preferred Grounding Configuration, Battery Systems .....	19
<b>8.0 WIRING CONSIDERATIONS</b> .....	<b>20</b>
8.1 Power Wiring .....	21
8.2 Control Wiring .....	24
8.3 Battery Wiring .....	24
<b>9.0 WIRING CONNECTIONS</b> .....	<b>25</b>
9.1 Specific Connections .....	26
<b>10.0 WIRING INSPECTION</b> .....	<b>27</b>
<b>11.0 INSTALLATION DRAWINGS</b> .....	<b>30</b>
<b>APPENDIX A - SITE PLANNING DATA, SERIES 610, 300-450KVA, SINGLE-MODULE SYSTEMS</b> ...	<b>71</b>

---

## FIGURES

Figure 1	Preferred grounding configuration, wye-connected service . . . . .	14
Figure 2	Alternate grounding configuration, wye-connected service . . . . .	15
Figure 3	Preferred grounding configuration with isolated bypass . . . . .	16
Figure 4	Alternate grounding configuration, non-isolated . . . . .	17
Figure 5	Grounding configuration, corner-grounded delta . . . . .	18
Figure 6	Grounding configuration, impedance-grounded wye . . . . .	18
Figure 7	Preferred battery cabinet grounding configuration . . . . .	19
Figure 8	Power single-line diagrams* . . . . .	22
Figure 9	Power single-line diagram, optional input transformer* . . . . .	23
Figure 10	Outline drawing, 300kVA Single-Module UPS . . . . .	30
Figure 11	Terminal details, 300kVA Single-Module UPS . . . . .	31
Figure 12	Outline drawing, 300kVA Single-Module UPS with input ISO transformer cabinet (optional) . . . . .	32
Figure 13	Terminal details, 300kVA Single-Module UPS with input ISO transformer cabinet (optional) . . . . .	33
Figure 14	Outline drawing, 400kVA Single-Module UPS . . . . .	34
Figure 15	Terminal details, 400kVA Single-Module UPS . . . . .	35
Figure 16	Outline drawing, 450kVA Single-Module UPS, 480V input, 480V output . . . . .	36
Figure 17	Terminal details, 450kVA Single-Module UPS, 480V input, 480/277V output . . . . .	37
Figure 18	Outline drawing, 400 & 450kVA Single-Module UPS with input ISO transformer cabinet (optional) . . . . .	38
Figure 19	Terminal details, 400 & 450kVA Single-Module UPS with input ISO transformer cabinet (optional) . . . . .	39
Figure 20	Base mounting patterns, 300-450kVA modules . . . . .	40
Figure 21	Battery power pack system . . . . .	41
Figure 22	Battery power pack, Size A . . . . .	42
Figure 23	Line-up detail, 300-500kVA Single- or Multi-Module System with battery cabinets . . . . .	43
Figure 24	Outline drawing, 300-450kVA, 24-in. Transformer Cabinet (optional) . . . . .	44
Figure 25	Line-up detail, 300-450kVA Single-Module System with input isolation transformer cabinet . . . . .	45
Figure 26	Line-up detail, 300-400kVA Single-Module System with Bypass Transformer Cabinet . . . . .	46
Figure 27	Outline drawing, 3-breaker Maintenance Bypass Cabinet, 125-400A . . . . .	47
Figure 28	Outline drawing, 3-breaker Maintenance Bypass Cabinet, 450-800A . . . . .	48
Figure 29	Line-up detail, 300-450kVA Single-Module System with 3-breaker Maintenance Bypass Cabinet . . . . .	49
Figure 30	Line-up detail, 300-450kVA Single-Module System with input isolation transformer cabinet and 3-breaker Maintenance Bypass Cabinet . . . . .	50
Figure 31	Control connection location diagram, Single-Module System, 300-500kVA . . . . .	51
Figure 32	Control wiring, external interconnect diagram, Single-Module System, 300-750kVA . . . . .	52
Figure 33	Control wiring, external interconnect diagram, Single-Module System with Maintenance Bypass Cabinet, 300-750kVA . . . . .	53
Figure 34	Control wire list, external interconnections, standard wiring, Single-Module System, 300-750kVA . . . . .	54
Figure 35	Control wire list, external interconnections, standard wiring, Single-Module System with Maintenance Bypass Cabinet, 300-750kVA . . . . .	55
Figure 36	Module control wiring, alarm status contacts option . . . . .	56
Figure 37	COM PWA, remote terminal (RS232) option, SiteScan option, internal modem option . . . . .	57
Figure 38	Control wiring, customer alarm interface option . . . . .	58
Figure 39	Control wiring, SNMP interface option . . . . .	59
Figure 40	Control wiring, remote status panel interface option . . . . .	60
Figure 41	Control wiring, battery temperature sensor interface . . . . .	61

---

Figure 42	Control wiring, maintenance bypass interlock option . . . . .	62
Figure 43	Control wiring, Maintenance Bypass Cabinet option . . . . .	63
Figure 44	Outline drawing, single-breaker module battery disconnect, 175-250A, 600VDC circuit breaker . . . . .	64
Figure 45	Outline drawing, dual-breaker module battery disconnect, 175-250A, 600VDC circuit breaker . . . . .	65
Figure 46	Outline drawing, single-breaker module battery disconnect, 300, 450, 600, 800, 1000, 1200A . . . . .	66
Figure 47	Outline drawing, dual-breaker module battery disconnect, 300 & 450A . . . . .	67
Figure 48	Outline drawing, dual-breaker module battery disconnect, 600, 800, 1000, 1200A . . . . .	68
Figure 49	Outline drawing, remote status panel, surface mount . . . . .	69

## TABLES

Table 1	Abbreviations for circuit breakers . . . . .	22
Table 2	Power wiring terminals, factory supplied . . . . .	27
Table 3	Torque specifications . . . . .	27
Table 4	Field-supplied lugs . . . . .	28
Table 5	Table 310-16, National Electrical Code (Reprint) . . . . .	29
Table 6	Site planning data—600V input. . . . .	72
Table 7	Site planning data—480V input. . . . .	73
Table 8	Site planning data—208V input. . . . .	74

---

---

## IMPORTANT SAFETY INSTRUCTIONS

---


### SAVE THESE INSTRUCTIONS

This manual contains important instructions that should be followed during installation of your Series 610 UPS and batteries.



#### WARNING

Exercise extreme care when handling UPS cabinets to avoid equipment damage or injury to personnel. The UPS module weight ranges from 4200 to 8170 lbs. (1905 to 3706kg), including input transformer. The battery cabinets weigh from 3060 to 5300 lbs. (1388 to 2404kg).

Locate center of gravity symbols  and determine unit weight before handling each cabinet. Test lift and balance the cabinets before transporting. Maintain minimum tilt from vertical at all times.

Slots at the base of the modules and battery cabinets are intended for forklift use. Base slots will support the unit only if the forks are completely beneath the unit.

Follow all battery safety precautions when installing, charging or servicing batteries. In addition to the hazard of electric shock, gas produced by batteries can be explosive and sulfuric acid can cause severe burns.

In case of fire involving electrical equipment, use only carbon dioxide fire extinguishers or those approved for use in fighting electrical fires.

Extreme caution is required when performing maintenance.

Be constantly aware that the UPS system contains high DC as well as AC voltages.

Check for voltage with both AC and DC voltmeters prior to making contact.

Read this manual thoroughly, paying special attention to the sections that apply to your installation, before working with the UPS. **Retain this manual for use by installing personnel.**



#### WARNING

Under typical operation and with all UPS doors closed, only normal safety precautions are necessary. The area around the UPS system should be kept free of puddles of water, excess moisture and debris.

Special safety precautions are required for procedures involving handling, installation and maintenance of the UPS system and the battery. Observe all safety precautions in this manual before handling or installing the UPS system. Observe all precautions in the Operation and Maintenance Manual, before as well as during performance of all maintenance procedures. Observe all battery safety precautions before working on or near the battery.

**This equipment contains several circuits that are energized with high voltage.** Only test equipment designed for troubleshooting should be used. This is particularly true for oscilloscopes. Always check with an AC and DC voltmeter to ensure safety before making contact or using tools. Even when the power is turned Off, dangerously high potential electric charges may exist at the capacitor banks and at the batteries.

**All power and control wiring should be installed by a qualified electrician.** All power and control wiring must comply with the NEC and applicable local codes.

**ONLY qualified service personnel should perform maintenance on the UPS system.** When performing maintenance with any part of the equipment under power, service personnel and test equipment should be standing on rubber mats. The service personnel should wear insulating shoes for isolation from direct contact with the floor (earth ground).

One person should never work alone, even if all power is removed from the equipment. A second person should be standing by to assist and summon help in case an accident should occur.



## CAUTION

This unit complies with the limits for a Class A digital device, pursuant to Part 15 Subpart J of the FCC rules and EN550022. These limits provide reasonable protection against harmful interference in a commercial environment. This unit generates, uses and radiates radio frequency energy and, if not installed and used in accordance with this instruction manual, may cause harmful interference to radio communications. Operation of this unit in a residential area may cause harmful interference that the user must correct at his own expense.



## NOTE

*Materials sold hereunder cannot be used in the patient vicinity (i.e., cannot be used where UL 60601-1, cUL 60601-1 or IEC 60601-1 is required). Medical Applications such as invasive procedures and electrical life support equipment are subject to additional terms and conditions.*



## 1.0 INSTALLATION CONSIDERATIONS

Install your Series 610 UPS in accordance with the submittal drawing package and the following procedures.

A Liebert authorized representative must perform the initial system check-out and start-up to ensure proper system operation. Equipment warranties will be voided unless system start-up is performed by a Liebert authorized representative. Contact your local Liebert sales representative or Liebert Global Services at 1-800-LIEBERT to arrange for system start-up.



### CAUTION

Read this manual thoroughly before attempting to wire or operate the unit. Improper installation is the most significant cause of UPS start-up problems.

Do not install this equipment near gas or electric heaters. It is preferable to install the UPS in a restricted location to prevent access by unauthorized personnel.

1. Proper planning will speed unloading, location and connection of the UPS. Refer to **Figures 10** through **49** and **Appendix A**.
2. Be certain that the floor at the final equipment location and along the route (inside the facility) to the installation site can support the cabinet weight and the weight of any moving equipment. The UPS modules can weigh from 4200 to 8170 lbs. (1905 to 3706kg). The battery cabinets weigh from 3060 to 5300 lbs. (1388 to 2404kg) each. Refer to **Appendix A**.



### WARNING

Locate center of gravity symbols  and determine unit weight before handling cabinet.

3. Plan the route to ensure that the unit can move through all aisleways and doorways and around corners without risking damage. If the modules and batteries must be moved by elevator, check the size of the door openings and the weight-carrying capacity of the elevator.
4. Refer to information later in this manual regarding the optional battery cabinet(s), Maintenance Bypass Cabinet and Transformer Cabinet. **Observe all battery safety precautions when working on or near the battery.**
5. Use the shortest output distribution cable runs possible, consistent with logical equipment arrangements and with allowances for future additions if planned.
6. Recommended ambient operating temperature is 77°F (25°C). Relative humidity must be less than 95%, non-condensing. Note that room ventilation is necessary, but air conditioning may not be required. Maximum ambient operating temperature is 104°F (40°C) without derating. The batteries should not exceed 77°F (25°C). At elevations above 4000 ft. (1219m), temperature derating may be required for full power output—consult your Liebert sales representative or call 1-800-LIEBERT.
7. Even though your Liebert UPS unit is 92 to 94% efficient, the heat output is substantial. For more specific information, see **Appendix A**. Be sure environmental conditioning systems can accommodate this BTU load, even during utility outages.
8. The installer should attempt to balance the load between the three output phases. The UPS will operate safely with an unbalanced load, but will give optimum performance if the three output phases are loaded within 20 percent of each other.
9. During normal UPS operations, short-term overload current demand from the bypass source may reach 10x the UPS output current rating. This overload current demand may be caused by the magnetizing inrush current of one or more downstream transformers or faults on downstream branch circuits. The instantaneous trip point(s) of the upstream bypass feeder breaker(s) must be set to support these temporary overloads. The magnitude of short-term overload bypass current demand is typically six to eight times the UPS current rating, but must be determined by analysis on a per-site basis. This analysis, generally known as an End-to-End Fault Coordination Study, must be done by a Registered Professional Engineer experienced in this activity and familiar with local codes and related requirements.



### NOTE

*While Liebert can provide typical guidelines, the responsibility for the proper breaker trip settings outside of the Liebert-manufactured UPS equipment resides with the owner. Contact Liebert Global Services at 1-800-LIEBERT for further details.*

10. A breaker coordination study should be performed to ensure proper handling of fault currents.



**NOTE**

*The instantaneous trip setting of the breaker feeding the UPS bypass input should be high enough to accommodate short-duration overloads. The bypass static switch inside the UPS can draw up to 10 times the system's rated current for up to three cycles.*

---

## 2.0 UNLOADING AND HANDLING

---

The UPS module is shipped in one cabinet to allow ease of handling at the site. Because the weight distribution in the cabinet is uneven, use extreme care during handling and transport. Your installation may also include battery cabinets, a Maintenance Bypass Cabinet and an optional transformer cabinet.



### WARNING

Exercise extreme care when handling UPS cabinets to avoid equipment damage or injury to personnel. The UPS module weight ranges from 4200 to 8170 lbs. (1905 to 3706kg), not including the optional transformer cabinet. Battery cabinets weigh from 3060 to 5300 lbs. (1388 to 2404kg).

Locate center of gravity symbols before handling cabinet. Test lift and balance the cabinet before transporting. Maintain minimum tilt from vertical at all times.

Slots at the base of the unit and battery cabinets are intended for forklift use. Base slots will support the unit only if the forks are completely beneath the unit.

To reduce the possibility of shipping damage, cabinets are shored with 2x4 bracing, secured with screw-type nails. This shoring must be carefully removed prior to unloading.



### CAUTION

Extreme care is necessary when removing shoring braces. Do not strike cabinet with hammers or other tools.

---

## 3.0 INSPECTIONS

---

### 3.1 External Inspections

1. While the UPS system is still on the truck, inspect the equipment and shipping container(s) for any signs of damage or mishandling. Do not attempt to install the system if damage is apparent. If any damage is noted, file a damage claim with the shipping agency within 24 hours and contact Liebert Global Services at 1-800-LIEBERT to inform them of the damage claim and the condition of the equipment.
2. Locate the bag containing the keys for the front access door. The bag is attached to the cabinet.
3. Compare the contents of the shipment with the bill of lading. Report any missing items to the carrier and to Liebert Global Services immediately.
4. Check the nameplate on the cabinet to verify that the model number corresponds with the one specified. Record the model number and serial number in the front of this installation manual. A record of this information is necessary should servicing become required.

### 3.2 Internal Inspections

1. Verify that all items have been received.
2. If spare parts were ordered, verify arrival.
3. Open doors and remove cabinet panels to check for shipping damage to internal components.
4. Check for loose connections or unsecured components in the cabinet(s).
5. Check for installation of circuit breaker line safety shields. There should be no exposed circuit breaker terminals when the cabinet doors are opened.
6. Check for any unsafe condition that may be a potential safety hazard.
7. UPS modules are shipped with internally mounted shipping brackets. The shipping brackets (painted orange) must be removed from the rear (remove rear panels). The installer must remove the orange shipping brackets before final equipment placement, particularly if rear access will be restricted.



## CAUTION

Failure to remove orange shipping brackets from transformers may cause restricted airflow within the UPS. This could cause overheating or reduction of UPS capacity. In some cases, it could cause damage to the UPS module, and such damage would not be covered under the factory warranty. If you foresee a situation where the UPS will be relocated in the near future, the brackets should be removed and stored elsewhere until they are needed.

---

## 4.0 EQUIPMENT LOCATION

---

1. Handle cabinet(s) in accordance with the safety precautions in this manual, especially in these sections:
  - **Battery Cabinet Precautions**—inside front cover
  - **Important Safety Instructions**—page 1
  - **2.0 - Unloading and Handling**—page 5
  - **5.0 - Battery Installation**—page 8

Use a suitable material handling device to move cabinet to its final location. **Exercise extreme care because of the uneven weight distribution.** Carefully lower the cabinet to the floor.

2. Verify that the UPS system is installed in a clean, cool and dry location.
3. Installation and serviceability will be easier if adequate access is provided on all sides of the equipment, but only front access is required.
  - a. Verify that there is adequate clearance to open cabinet doors—4 ft. (1.2m) is recommended. NEC requires sufficient clearance in front of the equipment to fully open all doors without restriction. See drawings and local codes.
  - b. Verify that there is adequate area in front of circuit breakers to perform maintenance. Check installation drawings for location of breakers. Check with local codes.
  - c. Verify that there is adequate clearance above all cabinets to allow exhaust air to flow without restriction. The minimum clearance is 2 ft. (0.6m), unobstructed by conduit or any other items. Liebert recommends against using top-feed air conditioning systems.
4. Align the UPS cabinet, battery cabinets (if used) and optional transformer and maintenance bypass cabinets, as shown in the Line-Up Detail drawings (**Figures 23, 25, 26, 29 and 30**) and your submittal package.
5. Connect the cabinets, internal cables and busbars, if applicable. Internal control connections should be left disconnected for later installation by Liebert LGS Customer Engineers.

---

## 5.0 BATTERY INSTALLATION

---

### 5.1 Battery Safety Precautions

Servicing of batteries should be performed or supervised by personnel knowledgeable of batteries and the required precautions. Keep unauthorized personnel away from batteries.

Be sure to observe the grounding recommendations in **7.0 - Configuring Your Neutral and Ground Connections** when installing batteries. When replacing batteries, use the same number and type of batteries.



### CAUTION

Lead-acid batteries contain hazardous materials. Batteries must be handled, transported and recycled or discarded in accordance with federal, state and local regulations. Because lead is a toxic substance, lead-acid batteries must be recycled rather than discarded.

Do not open or mutilate the battery or batteries. Released electrolyte is harmful to the skin and eyes. It is toxic. Do not dispose of battery or batteries in a fire. The battery may explode.

Do not install any batteries that are cracked, leaking or show other signs of damage. Contact Liebert Global Services or your local Liebert representative.

A battery can present a risk of electrical shock and high short circuit current. The following precautions should be observed when working on batteries:

- Remove watches, rings and other metal objects.
- Use tools with insulated handles.
- Wear rubber gloves and boots.
- Do not lay tools or metal parts on top of batteries.
- Disconnect charging source prior to connecting or disconnecting battery terminals.
- Determine if battery is inadvertently grounded. If inadvertently grounded, remove source of ground. Contact with any part of a grounded battery can result in electrical shock. The likelihood of such shock will be reduced if such grounds are removed during installation and maintenance.

Lead-acid batteries can present a risk of fire because they generate hydrogen gas. The following procedures should be followed:

- DO NOT SMOKE when near batteries.
- DO NOT cause flame or spark in battery area.
- Discharge static electricity from body before touching batteries by first touching a grounded metal surface.
- After replacing battery jars in a battery cabinet, replace the retaining straps that hold the jars in place on the shelves. This will limit accidental movement of the jars and connectors should the cabinet ever need to be repositioned or relocated. Regular maintenance of the battery module is an absolute necessity. Periodic inspections of battery and terminal voltages, specific gravity and connection resistance should be made. Strictly follow the procedures outlined in the battery manufacturer's manual, available on the manufacturer's Web site.

## 5.2 Battery Safety Precautions in French Per CSA Requirements

### Instructions Importantes Concernant La Sécurité Conserver Ces Instructions



## AVERTISSEMENT

Respecter toutes les consignes de sécurité applicables à l'installation, le chargement ou l'entretien des batteries. En plus du danger de chocs électriques, le gaz produit par les batteries peut exploser dégageant de l'acide sulfurique qui peut entraîner de très graves brûlures.

Toute opération d'entretien/réparation des batteries doit être exécutée ou supervisée par un personnel qualifié dans le domaine et en prenant toutes les précautions nécessaires. Tenir le personnel non autorisé à l'écart des batteries.



## ATTENTION

Les batteries acide-plomb contiennent des substances toxiques dangereuses. Les batteries doivent être manipulées, transportées et recyclées ou jetées conformément à la réglementation en vigueur aux niveaux national et local. Le plomb étant toxique, les batteries acide-plomb doivent être recyclées et non jetées.

Ne pas ouvrir ni endommager la ou les batteries. Les électrolytes diffusés sont dangereux pour la peau et les yeux. Ils sont toxiques. Ne pas jeter la ou les batteries dans le feu. Risque d'explosion.

Ne jamais installer de batteries avec des cellules fissurées ou endommagées. Contacter Liebert Global Services ou le représentant agréé Liebert local.

Une batterie peut poser un risque de choc électrique et de courant élevé provoqué par un court-circuit. Respecter les précautions suivantes lors de travaux sur les batteries:

- Enlever montres, bagues ou autres objets métalliques.
- Utiliser des outils dont les poignées sont isolées.
- Porter des gants et des bottes en caoutchouc.
- Ne pas poser d'outils ou d'objets métalliques sur les batteries.
- Déconnecter la source de chargement avant de connecter ou de déconnecter les bornes de batterie.
- Vérifier que la batterie n'a pas été mise à la masse par inadvertance. Si elle est mise à la masse, éliminer la source de masse. Tout contact avec des composants de batterie mise à la masse peut entraîner un choc électrique. Éliminer le risque de chocs électriques potentiels en retirant les sources de masse avant l'installation et la maintenance.

Les batteries acide-plomb peuvent représenter un risque d'incendie puisqu'elles génèrent de l'hydrogène. Respecter les procédures suivantes:

- NE PAS FUMER près des batteries.
- NE PAS générer de flammes ou d'étincelles près des batteries.
- Éliminer l'électricité statique du corps avant de manipuler les batteries en touchant d'abord une surface métallique mise à la terre.

L'électrolyte est un acide sulfurique dilué qui est dangereux au contact de la peau et des yeux. Ce produit est corrosif et aussi conducteur électrique. Les procédures suivantes devront être observées:

- Porter toujours des vêtements protecteurs ainsi que des lunettes de protection pour les yeux.
- Si l'électrolyte entre en contact avec la peau, nettoyer immédiatement en rincant avec de l'eau.
- Si l'électrolyte entre en contact avec les yeux, arroser immédiatement et généreusement avec de l'eau. Demander pour de l'aide médicale.
- Lorsque l'électrolyte est renversée, la surface affectée devrait être nettoyée en utilisant un agent neutralisant adéquat. Une pratique courante est d'utiliser un mélange d'approximativement une livre (500 grammes) de bicarbonate de soude dans approximativement un gallon (4 litres) d'eau. Le mélange de bicarbonate de soude devra être ajouté jusqu'à ce qu'il n'y ait plus apparence de réaction (mousse). Le liquide résiduel devra être nettoyé à l'eau et la surface concernée devra être asséchée.

### 5.3 Battery Cabinets

Optional battery cabinets are available from Liebert and other qualified vendors. Consult your submittal package for details.

Several models of optional battery cabinets with varying run times are available. Each model is 78" (1981mm) high and has forklift slots. Refer to **Figures 21** and **22**. The battery cabinet cells range from 90 to 150 ampere-hours. The same model battery cabinet may be paralleled in multiple cabinet strings for additional capacity. Battery capacity (in minutes) at your installation will depend on cabinet model, number of cabinets, and amount of critical load on the UPS.

1. **Handling.** The battery cabinet weighs from 3060 to 5300 lbs. (1388 to 2404kg). Forklift slots are provided for ease of handling.
2. **Cabinet Inspection.** Remove all panels and visually inspect the batteries, bus connections, and cabinet for any damage. If any foam blocks were placed between shelves to restrain movement during shipment, remove them now. **Exercise caution—voltage is present within the battery cabinet even before installation.** If there are signs of damage, do not proceed. Call Liebert Global Services at 1-800-LIEBERT.
3. **Battery Storage.** The batteries used in the battery cabinet retain their charge well. The batteries can be stored indoors in a temperature-controlled environment, for up to six months without any appreciable deterioration. Self-discharge rate of the batteries is approximately 3% per month when the batteries are stored in temperatures of 59°F to 77°F (15-25°C). If the battery cabinet must be stored for longer than six months, contact Liebert Global Services. The battery cabinet should never be stored outdoors or on a loading dock.
4. **Installation.** The battery cabinet(s) can be located conveniently next to the UPS module. The front-access-only-design eliminates side and rear service clearance requirements.
5. **Reinstallation.** If at any time it becomes necessary to move the battery cabinet to another location, contact Liebert Global Services to inspect the internal battery hold-down straps.
6. **Environment.** Locate the battery cabinet in a clean, dry environment. Recommended temperature range for optimum performance and lifetime is 68°F to 77°F (20-25°C).
7. **Service Clearance.** Allow front access to the battery cabinet at all times for maintenance and servicing. Electrical codes require that the battery cabinet be installed with no less than 3 ft. (1m) of clearance at the front of the cabinet when operating. Side and rear panels do not require service clearance.
8. **Side Panels.** To connect battery cabinets together, remove the protective side panels by removing the retaining screws that hold the side panels in place.
9. **Cables.** Multiple battery cabinets may be bolted together in a daisy-chain configuration. Cables for this setup may be run between paralleled battery cabinets through cutouts in the top of the cabinets, eliminating the need for external conduit runs. **Route cables before moving cabinets into final position for bolting together.** Low voltage control wiring must be kept separate from the power wiring. Remove top panels for access. No top or bottom entry cables are required, except for remotely located cabinets, which require conduits. The final connections, including power and control wiring, between the last battery cabinet and the UPS system must be run externally in the 300-450kVA systems. Refer to **Figures 21** through **23** or your submittal drawings for instructions on wiring cabinets in parallel.



#### NOTE

*The 300-750kVA UPS module is approximately 2 to 6 in. (51-152mm) deeper than the battery cabinet and is not designed to bolt directly to it.*

10. **Grounding.** The battery cabinets have ground studs near the busbar connections. Use an equipment grounding conductor to connect the lugs of the cabinets together and to connect the cabinets to the ground busbar in the UPS module.



## 5.4 Open-Rack Batteries

When batteries other than Liebert battery cabinets are used, a remote battery disconnect switch with overcurrent protection is required per the National Electrical Code. Refer to Required Battery Disconnect Rating in the site planning data tables in **Appendix A** for recommended overcurrent protection ratings. Contact your Liebert sales representative for more information.

1. Install battery racks/cabinets and batteries per manufacturer's installation and maintenance instructions.
2. Verify battery area has adequate ventilation and battery operating temperature complies with manufacturer's specification. Installations using vented lead-acid batteries **MUST** have adequate ventilation to remove explosive gases per local and national codes.
3. Low voltage control wiring must be kept separate from power wiring and run in separate conduits.
4. Ensure that battery racks are properly grounded according to code requirements in your area.

If you have any questions concerning batteries, battery racks or accessories, contact your local sales representative or Liebert Global Services at 1-800-LIEBERT.



### **CAUTION**

Cables between batteries and the UPS should be run in matched pairs, positive-with-negative, within each conduit or cable run. Grouping like-polarity cables together (i.e., positive-with-positive and negative-with-negative) can cause stress or damage to the cables, conduit or buswork.

## **6.0 OPTIONAL TRANSFORMER CABINET**

---

The optional transformer cabinet is a free-standing enclosure that must be bolted to the right side of the UPS module. Forklift slots are included in the cabinet base for ease of handling. Power and control cables for UPS system interconnections are provided with each cabinet.

The optional Transformer Cabinet (**Figures 12, 13, 18, 19, 24, 25 and 30**) encloses the Rectifier Isolation Transformer. The cabinet is cooled by fans, with a disposable filter at the bottom.

## 7.0 CONFIGURING YOUR NEUTRAL AND GROUND CONNECTIONS

Improper grounding is the largest single cause of UPS installation and start-up problems. This is not an easy subject, since grounding techniques vary significantly from site to site, depending on several factors. The questions you should ask are:

- What is the configuration of the input power source? Most of the recommended schemes for UPS grounding require grounded-wye service. The UPS system requires a bypass neutral for sensing and monitoring the quality of the bypass input. If the building service is ungrounded delta or corner-grounded delta, contact your Liebert representative for details about Isolated Neutral kits. A Power-Tie or distributed redundant system has different grounding requirements from stand-alone UPS modules. If using one of those systems, refer to Liebert's Power-Tie configuration user manual, SL-30030.
- Does the system have a bypass isolation transformer? Systems with 480 VAC (or 600 VAC) input and 208 VAC output require a bypass isolation transformer. In some cases, it may be necessary to treat that transformer as a "separately derived source" with its own grounding electrode.
- What are the UPS input and output voltages? Systems with 480 VAC input and output have significantly different needs from systems with 480/208 VAC or 208/208 VAC.
- What is the connected load? Does the critical load consist of one or more Power Distribution Units (PDUs)? Do the PDUs have isolation transformers?

Proper grounding should be based on NEC Section 250, but safe and proper equipment operation requires further enhancements. The following pages detail Liebert's recommendations for grounding various system configurations to ensure optimal UPS system performance.



### NOTE

*Some UPS modules are equipped with input isolation transformers. However, these transformers have no effect upon any system grounding considerations. These modules will be grounded exactly as shown in **Figures 1 through 7**.*



### CAUTION

The UPS ground lug must be solidly connected to the service entrance ground by an appropriately sized wire conductor per NEC Article 250. Each conduit or raceway containing phase conductors must also contain a ground wire, both for UPS input and output, which are solidly connected to the ground terminal at each termination point. Conduit-based grounding systems tend to degrade over time. Therefore, using conduit as a grounding conductor for UPS applications may degrade UPS performance and cause improper UPS operation.

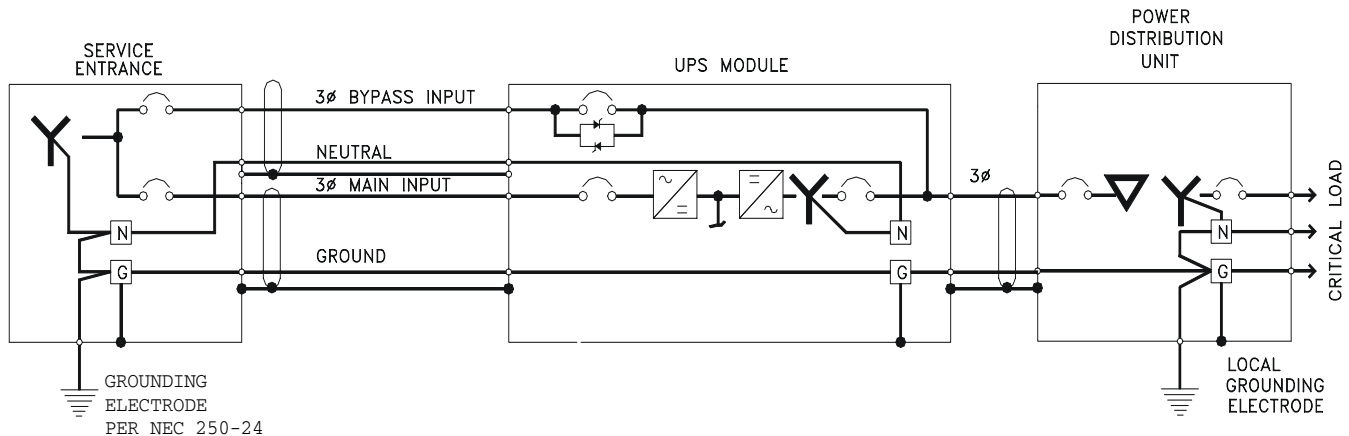
## 7.1 Preferred Grounding Configuration, Wye-Connected Service

One of the most common configurations of Series 610 UPS Single-Module Systems is with 480 VAC input, 480 VAC output and a connected load consisting of multiple Power Distribution Units (PDUs) with isolation transformers in the PDUs to produce 208 VAC. For Canadian customers, the UPS modules usually have 600 VAC input and output. The same principles apply if the connected load is an isolation transformer feeding various loads. **Figure 1** shows a typical installation.

Notice that the UPS module main input and bypass input are connected to a grounded-wye service. In this configuration, the UPS module is not considered a separately derived source. The UPS module output neutral is solidly connected to the building service neutral, which is bonded to the grounding conductor at the service entrance equipment.

The isolation transformers in the PDUs are considered a separately derived source. Therefore the PDU neutral should be bonded to the PDU grounding conductor and connected to a local grounding electrode in compliance with NEC 250-26.

**Figure 1 Preferred grounding configuration, wye-connected service**



Advantages of this configuration include:

- A measure of common-mode noise attenuation, since the isolation (common-mode rejection) occurs as close to the load as practical (i.e., at the PDU).
- The UPS module can be located remotely from the PDU without compromising common-mode noise performance.
- By using UPS modules with 480 VAC input and output and creating 208 VAC at the PDU, smaller and less costly power feeders can be used and less voltage drop (as a percent of nominal) occurs.



### NOTE

*Impedance-grounded wye sources must be grounded in accordance with 7.5 - Grounding Configuration, Corner-Grounded Delta or Impedance-Grounded Wye.*



### NOTE

*Some UPS modules are equipped with input isolation transformers. However, these transformers have no effect upon any system grounding considerations. These modules will be grounded exactly as shown in these pages.*



### NOTE

*If there is a 4-pole Automatic Transfer Switch (ATS) between the service entrance and the UPS, this configuration cannot be used. Refer to 7.2 - Alternate Grounding Configuration, Wye-Connected Service or 7.3 - Preferred Grounding Configuration With Isolated Bypass to determine a suitable configuration.*

## 7.2 Alternate Grounding Configuration, Wye-Connected Service

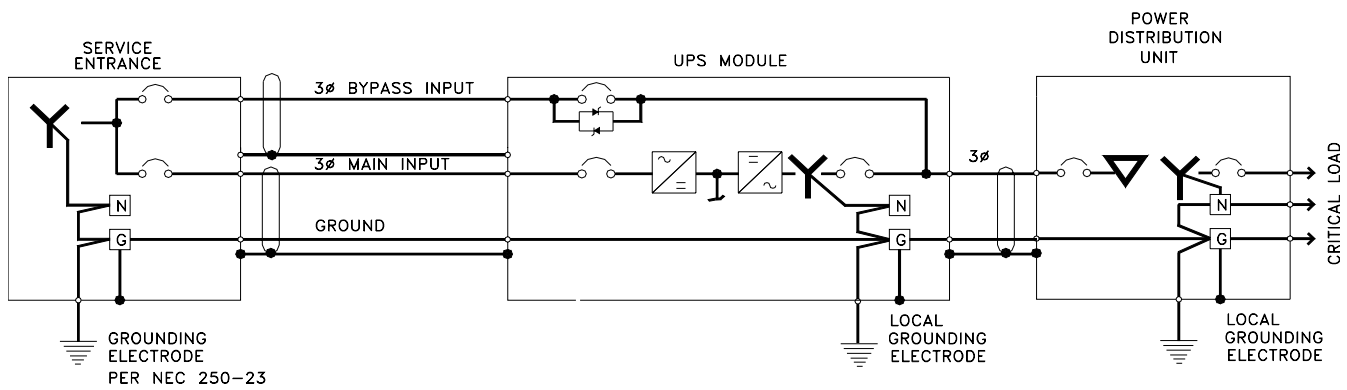
This configuration must NOT be used when single-phase loads are directly connected to the UPS.

The alternate configuration is similar to that shown in 7.1 - Preferred Grounding Configuration, Wye-Connected Service, except that the service entrance neutral is not brought into the UPS module. In this configuration, the UPS output transformer is considered a separately derived source. The UPS module neutral is bonded to the UPS ground, which is connected to a local grounding electrode in accordance with NEC 250-26.

Please note that this configuration represents a price/performance trade-off. Whenever the UPS module transfers to or from bypass, two AC sources (input and bypass) are briefly connected together and circulating current must flow. In the previous configuration, the current flows through the neutral conductor. In this configuration, the current flows through the ground path, possibly tripping ground fault interrupters (GFIs) and distorting the bypass waveform reference.

Proper adjustment of ground fault interrupters is necessary to avoid unwanted tripping.

**Figure 2** Alternate grounding configuration, wye-connected service



This configuration is reserved for applications that meet all the following criteria:

- The facility has wye-connected service.
- The module rectifier input and bypass input are fed from the same source.
- The connected load is strictly 3-wire (such as one or more PDUs) and does not require a neutral from the UPS.
- Special precautions are taken to prevent tripping the ground fault interrupters. The time delay should be set to at least 0.2 seconds to prevent tripping when the UPS performs a transfer or retransfer operation.



### CAUTION

Failure to properly set the ground fault interrupters could cause loss of power to the critical load.

### 7.3 Preferred Grounding Configuration With Isolated Bypass

Another configuration in this power range is the Single-Module System with 480 or 600 VAC input, 208 VAC output, a Bypass Isolation Transformer and a connected load consisting of multiple distribution panelboards or switchboards. **Figure 3** shows a typical installation.

The Bypass Transformer provides isolation and may step down the voltage to the bypass input. The Bypass Transformer and the UPS module together constitute a separately derived system, since there is no direct electrical connection between the input (service entrance) circuit conductors and the output circuit conductors.

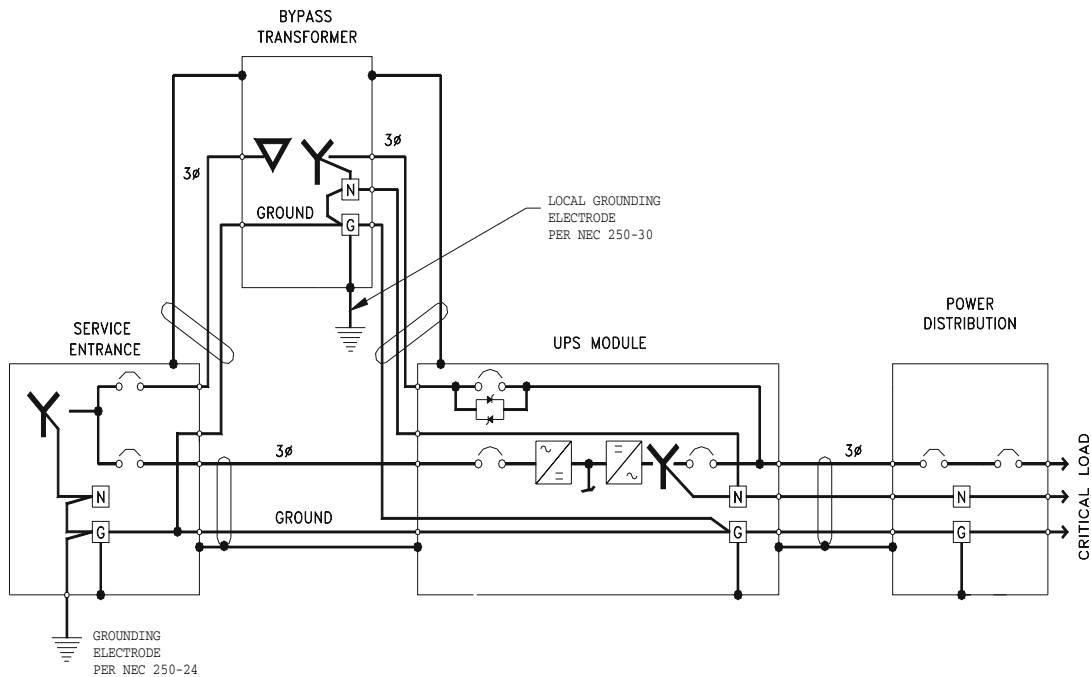


#### NOTE

**Figure 3** shows a wye-connected source, but the same grounding scheme would apply for a delta source at the service entrance.

The bonding of the neutral to the grounding conductor can theoretically be done at either the UPS module or the Bypass Transformer. However, we recommend bonding at the Bypass Transformer because the UPS module will sometimes be powered down for maintenance and its output transformer will be out of the circuit. The neutral should be bonded to ground and a local grounding electrode should be installed at the Bypass Transformer, per NEC 250-30.

**Figure 3 Preferred grounding configuration with isolated bypass**



Features of this configuration include:

- The UPS receives its bypass neutral from the Bypass Transformer
- The output is isolated from the input circuit conductors, and
- Some amount of common-mode noise attenuation can be obtained for sensitive loads **if** the UPS module and Bypass Transformer are located close to sensitive loads.

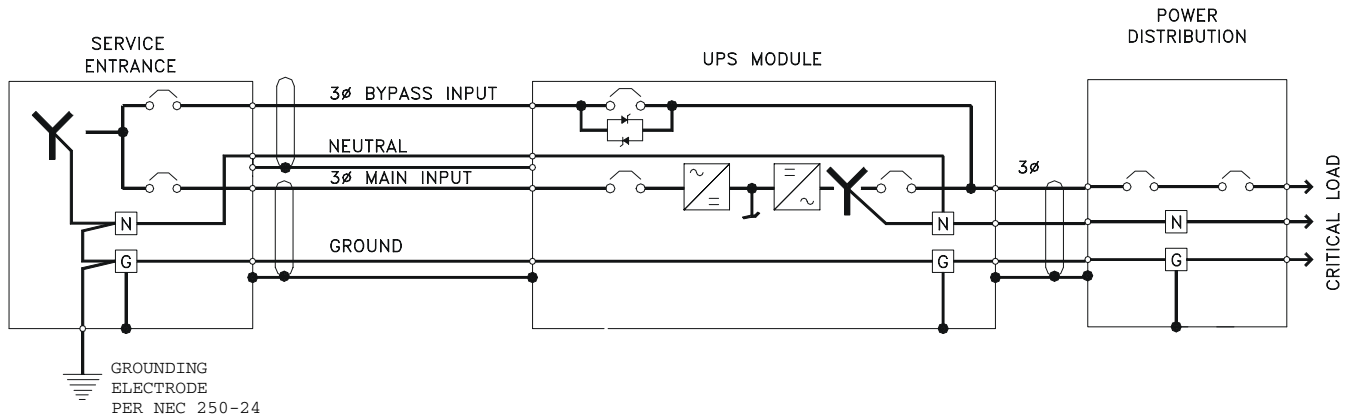
## 7.4 Alternate Grounding Configuration, Non-Isolated

A few applications in this power range have 208 VAC input and output, and a connected load consisting of multiple Power Distribution Units (PDUs), panelboards, switchboards or other items of load equipment which do not have isolation transformers.

Notice in **Figure 4** that the UPS module main input and bypass input are connected to a grounded-wye service. In this configuration, the UPS module is not considered a separately derived source.

The UPS module output neutral and the load neutral are solidly connected to the building service neutral, which is bonded to the grounding conductor at the service entrance equipment.

**Figure 4** Alternate grounding configuration, non-isolated



This arrangement may be used for systems with 208 VAC input and output. However, it does not provide any isolation or common-mode noise attenuation for sensitive loads. For this reason, this configuration is not a preferred installation method.



### NOTE

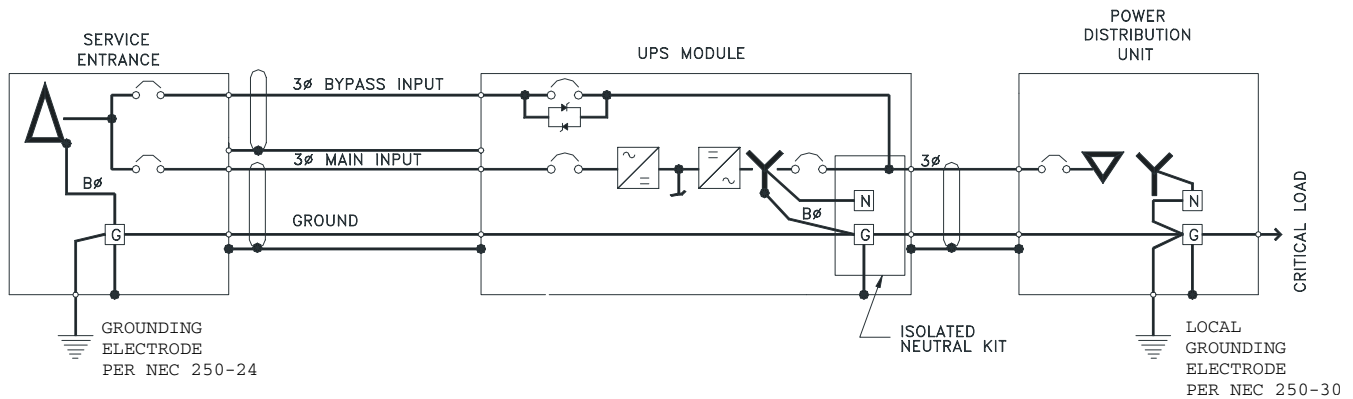
*If there is a 4-pole Automatic Transfer Switch (ATS) between the service entrance and the UPS, this configuration cannot be used. Refer to 7.3 - Preferred Grounding Configuration With Isolated Bypass to determine a suitable configuration.*

## 7.5 Grounding Configuration, Corner-Grounded Delta or Impedance-Grounded Wye

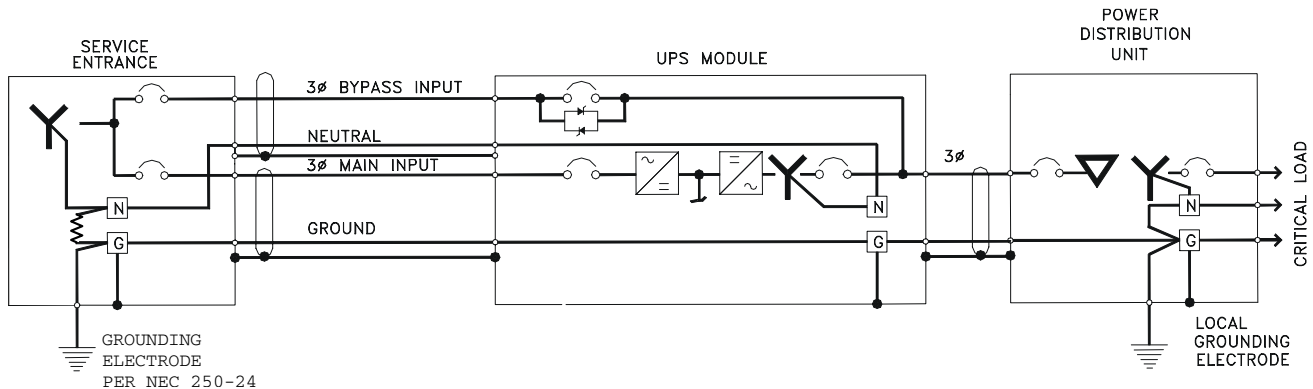
As previously mentioned, Series 610 UPS modules require a bypass input neutral for sensing and monitoring. With a wye-connected input source, the installer should always connect the building service neutral to the module output neutral to achieve this. When the building service is delta-connected, however, the installer must take special steps to ensure reliable UPS functioning.

If the building service is corner-grounded delta or impedance-grounded wye, the UPS requires the Series 610 Isolated Neutral Kit. This kit uses control isolation transformers to create a reference point. For this application, the UPS output neutral *must not* be bonded to the UPS ground.

**Figure 5** Grounding configuration, corner-grounded delta



**Figure 6** Grounding configuration, impedance-grounded wye



These configurations have the same restrictions as explained in **7.2 - Alternate Grounding Configuration, Wye-Connected Service**, except for the wye input. The UPS input and bypass must be fed from the same source. The load must be strictly 3-wire. And the GFI time delay should be set to at least 0.2 seconds to prevent tripping during transfer or retransfer operations.



### CAUTION

Failure to properly set the ground fault interrupters could cause loss of power to the critical load.



## 7.6 Preferred Grounding Configuration, Battery Systems

**Open-rack battery systems**, depending on local code requirements and customer preference, are normally:

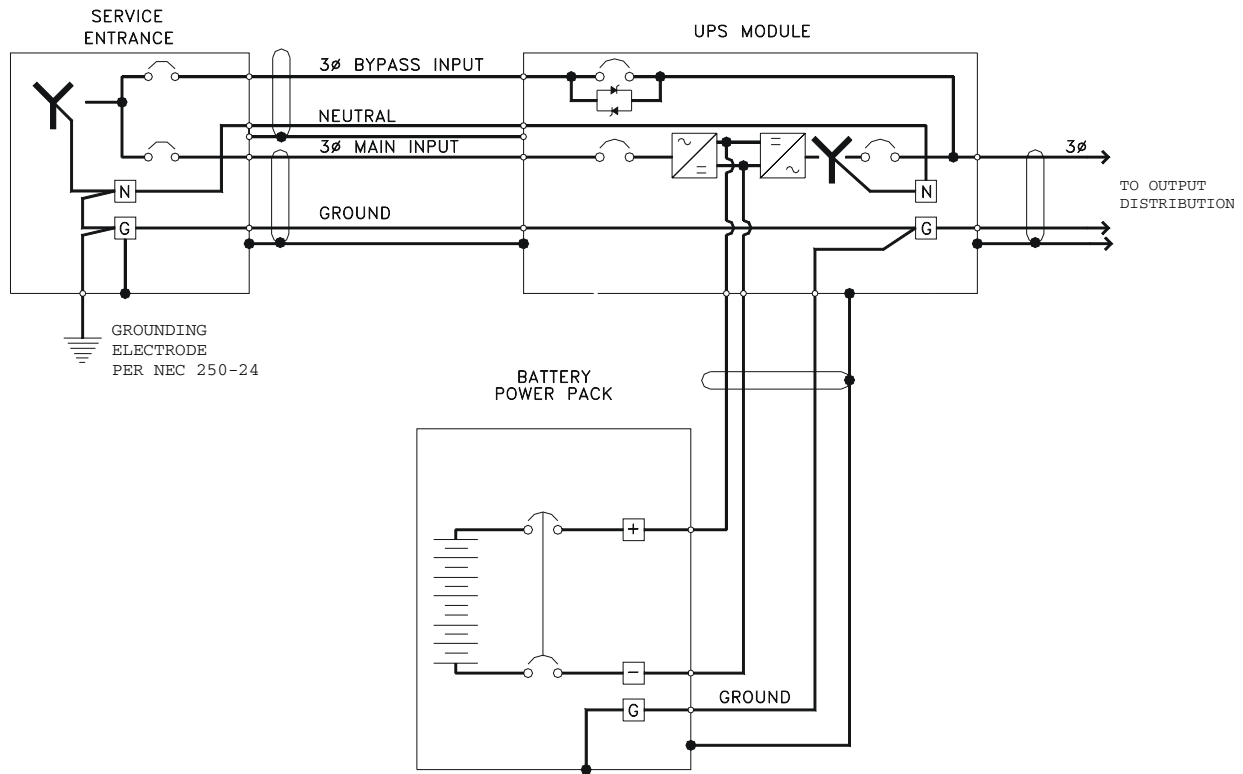
1. Floating (ungrounded),
2. Center-tapped and floating or
3. Center tapped and grounded.

**Battery cabinet systems** must be connected as floating (ungrounded) systems—**Option 1** above. Center-tapped or grounded battery systems are not possible with battery cabinet systems.

Whether the battery system is open-rack or cabinet, the metal rack parts or cabinet must be grounded to the UPS module ground bus.

**Figure 7** illustrates how a simple, one-cabinet system would be grounded. For systems with multiple cabinets, the same configuration would apply. However, for simplicity, the installer can connect all the battery cabinet grounds for a particular module together and run a single ground conductor to that UPS module ground (in the same conduit as the phase conductors).

**Figure 7 Preferred battery cabinet grounding configuration**



---

## 8.0 WIRING CONSIDERATIONS

---



### WARNING

All power connections must be completed by a licensed electrician experienced in wiring this type of equipment. Wiring must be installed in accordance with all applicable national and local electrical codes. Improper wiring may cause damage to the equipment or injury to personnel.

Verify that all incoming high and low voltage power circuits are de-energized and locked out before installing cables or making any electrical connections.

Refer to **Appendix A** and drawings in **11.0 - Installation Drawings**. Determine AC currents for your system (kVA, voltage and options). Also refer to the equipment nameplate for the model number, rating and voltage. For wire termination data, refer to **Tables 2** through **4**.



### NOTE

*Use 75°C copper wire. Select wire size based on the ampacities in **Table 5** of this manual, a reprint of Table 310-16 and associated notes of the National Electrical Code (NFPA 70).*



### CAUTION

The weight of power cables must be adequately supported to avoid stress on busbars and lugs. In addition to weight support, the following restraining method is recommended to control cable movement during external fault conditions:

- Wrap line cables together at 6 and 12 in. (152 and 305mm) from the terminals with five wraps of 3/8 in. (9.5mm) nylon rope or equivalent (tensile strength of 2000 lbs.; 907kg).
- Support the remainder of the cable with five wraps every 6 in. (152mm) or one wrap every 1 in. (25mm).

## 8.1 Power Wiring

1. Power wiring—rectifier input, bypass input, UPS output and battery cables—must be run in individual, separate conduits or cable trays. Refer to the Outline and Terminal Details drawings (**Figures 10 through 19, 24, 27, 28 and 44 through 49**) for locations of the various power connections within the UPS and ancillary equipment. In particular, note the location of the rectifier input power connections.



### CAUTION

Power and control wiring must be separated!

2. Observe local, state and national electrical codes. Verify utility power and its overcurrent protection rating will accommodate the UPS input rating, including battery recharging.
3. A safety ground wire must be run from the building ground to a ground point in the UPS Module Cabinets, ancillary equipment, and the Power-Tie Cabinet (if applicable). See **7.0 - Configuring Your Neutral and Ground Connections**. The grounding conductor shall comply with the following conditions of installation:
  - a. An insulated grounding conductor must be sized in accordance with the NEC and local codes. It must be green (with or without one or more yellow stripes) and be installed as part of the branch circuit that supplies the unit or system.
  - b. The grounding conductor described above is to be grounded to earth at the service equipment or, if supplied by a separately derived system, at the supply transformer or motor-generator set in accordance with the instructions in **7.0 - Configuring Your Neutral and Ground Connections**.
  - c. The attachment-plug receptacles in the vicinity of the unit or system are all to be of a grounding type, and the grounding conductors serving these receptacles are to be connected to earth ground at the service equipment.
4. Observe clockwise phase rotation of all power wiring. Phase A leads Phase B leads Phase C. A qualified electrician should check the phase rotation.
5. AC power cables must be rated for less the NEC-rated line drop at the maximum rated system current. DC power cables from the UPS to the battery terminals and return must be sized for less than 2 volts total loop drop at the maximum rated system current.
6. If site equipment includes a backup generator and automatic transfer switch(es), consult the manufacturers of those devices for information on sizing and interfacing to the UPS system.
7. Removable access plates are available for power wiring. Refer to the Outline Drawings (**Figures 10, 12, 14, 16, 18, 24, 27, 28 and 44 through 49**) for your particular model.



### CAUTION

After cutting holes in the access plates, be certain that no foreign matter (metal shavings, sawdust, insulation or wire fragments, etc.) remains inside the UPS. Likewise be certain to block any “extra” holes in the plates through which foreign matter could later enter the UPS.

Figure 8 Power single-line diagrams\*

\* These configurations are for illustrative purposes only. They represent only a sample of the possible configurations. Refer to the submittals supplied with your order for more information or for order-specific details.

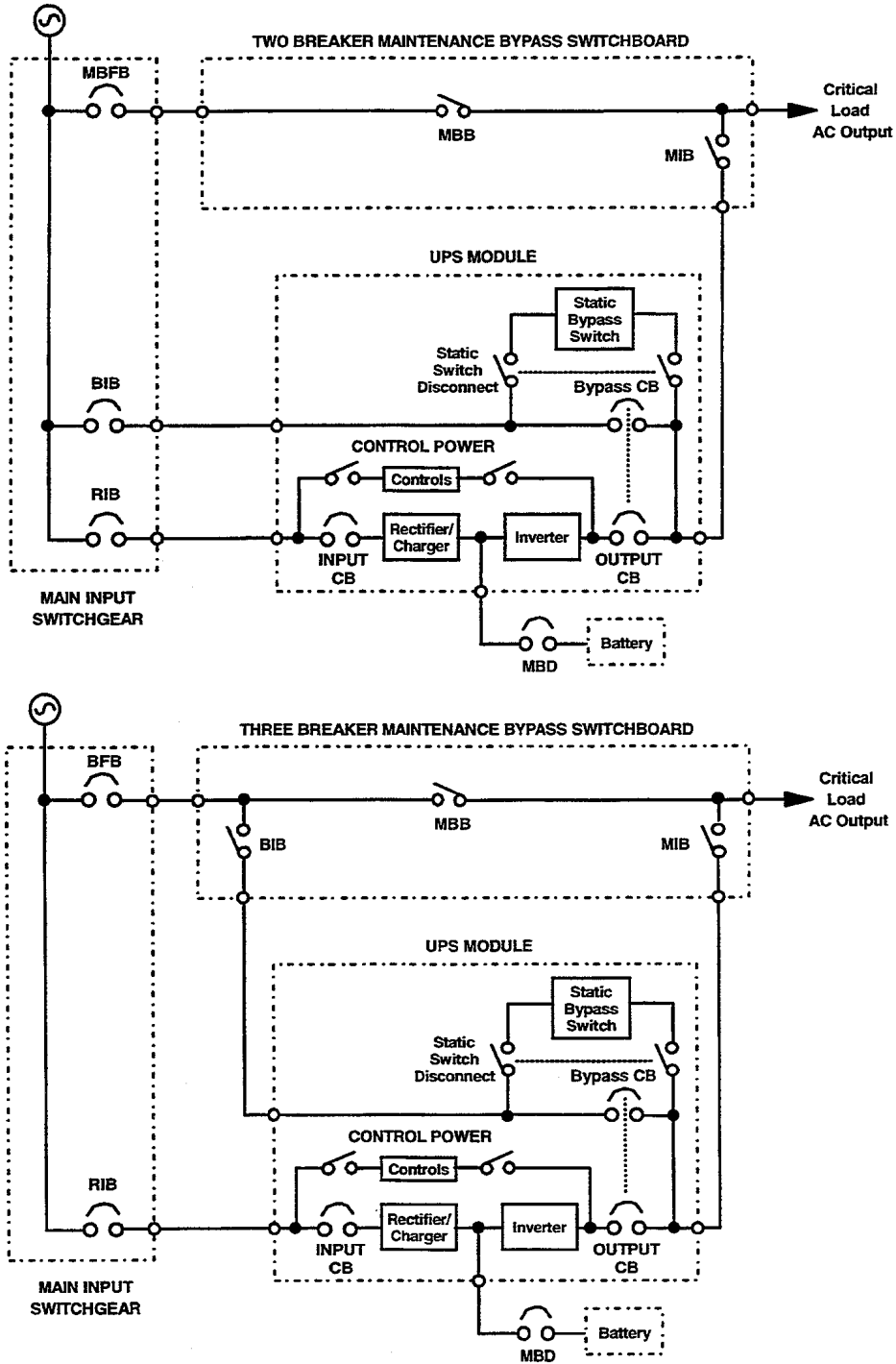
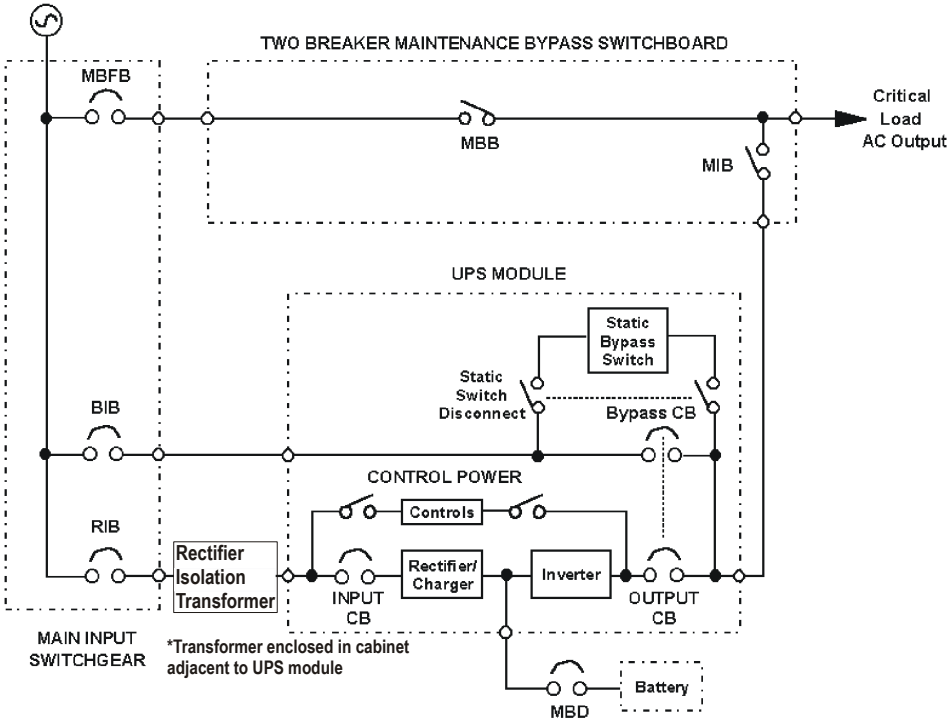


Table 1 Abbreviations for circuit breakers

BFB	Bypass Feeder Breaker
BIB	Bypass Input Breaker
MBB	Maintenance Bypass Breaker
MBD	Module Battery Disconnect
MBFB	Maintenance Bypass Feeder Breaker
MIB	Maintenance Isolation Breaker
RIB	Rectifier Input Breaker

Figure 9 Power single-line diagram, optional input transformer\*

\* This configuration is for illustrative purposes only. It represents only a sample of the possible configurations. Refer to the submittals supplied with your order for more information or for order-specific details.



## 8.2 Control Wiring

Control wiring must be flexible stranded, tinned copper and run in individual separate steel conduits. Control wiring must be separated from power wiring. In addition, each control wiring cable group should be run in a separate conduit to minimize control signal interference.

If your system has any installed options, special wire lists will be included in your Submittal Drawing Package. Contact your Liebert Sales Representative for assistance if the submittal drawings have been lost or misplaced.

All control cable groups are connected to different Interface Modules (IFMs) and/or terminal blocks inside the UPS. **Figure 31** shows the typical location of each IFM inside the UPS. The position of a particular IFM may be different for your UPS, depending on the model and the installed options.



### NOTE

*The UPS control and communication wiring are considered Class 2 circuits by NEC standards. However, NEC Class 1 wiring methods are required for these circuits to ensure proper operation of the UPS.*

## 8.3 Battery Wiring

Power wiring to the battery cabinet connects positive, negative, and ground power cables from the battery cabinet to the associated UPS. Connection of the UPS to the battery cabinet serves to both charge and discharge the batteries (when needed). The battery disconnect (circuit breaker) requires a control cable. Except for interconnect wiring between multiple battery cabinets, power and control cables are field supplied. Refer to **Figures 21** through **23**.



### WARNING

A battery intercell connection on each tier of the Liebert battery cabinet is disconnected for safety during shipment. Do not complete these connections. A Liebert Global Services representative will complete these connections as part of start-up. An improperly installed unit can result in injury to personnel or damage to equipment.



### CAUTION

Be sure polarity is correct when wiring the battery cabinet to the connected equipment (positive to positive; negative to negative). If polarity is not correct, fuse failures or equipment damage can result.



### CAUTION

Cables between batteries and the UPS should be run in matched pairs, positive-with-negative, within each conduit or cable run. Grouping like-polarity cables together (i.e., positive-with-positive and negative-with-negative) can cause stress or damage to the cables, conduit or buswork.

Call Liebert Global Services to schedule installation check-out, final battery intercell connections and start-up.



### NOTE

*A Liebert Battery Specialist can perform a detailed inspection of the entire battery system to ensure it meets current IEEE standards. This inspection service is recommended because batteries are a very critical part of the UPS system.*

---

## 9.0 WIRING CONNECTIONS

---



### WARNING

Verify that all incoming high and low voltage power circuits are de-energized and locked out before installing cables or making electrical connections.

All power connections must be completed by a licensed electrician experienced in wiring UPS equipment and in accordance with all applicable national and local electrical codes.

Improper wiring may cause damage to the UPS or injury to personnel.



### CAUTION

All shielded cables, non-shielded cables, non-shielded control wires, non-shielded battery breaker control wires and non-shielded remote control wires must be housed in individual, separate, steel conduits. Placing multiple cables in the same conduit with other control or power wiring may cause system failure.



### NOTE

*Use appropriately sized wire as a grounding conductor. Solid metal conduit is not a suitable ground conductor for UPS systems and could negatively affect system performance.*

## 9.1 Specific Connections

Refer to the drawings in this manual and any other drawings provided by Liebert for this installation.



### NOTE

*If your installation includes a Maintenance Bypass Panelboard or a Transformer Cabinet, some or all power cables will be terminated in these cabinets. Make sure all required wiring between the UPS module and the optional cabinets is completed per the submittal drawings. Observe phase rotation.*

Make all of the following connections:

1. AC power cables from input power source circuit breaker (RIB) to UPS Module Input. Observe phase rotation.
2. AC power cables from bypass power source circuit breaker (BIB) to UPS Module Bypass input. Observe phase rotation.



### CAUTION

If there are line-to-neutral loads connected to the UPS output, the bypass input source must be wye connected and have three phases plus neutral plus ground. If the specified input is not available, an isolation transformer is required. Refer to **7.1 - Preferred Grounding Configuration, Wye-Connected Service**, **7.3 - Preferred Grounding Configuration With Isolated Bypass** and **7.4 - Alternate Grounding Configuration, Non-Isolated**.

See **7.0 - Configuring Your Neutral and Ground Connections** for an explanation of proper grounding techniques.

3. AC power cables from UPS Module Output to critical load. Observe phase rotation.



### CAUTION

UPS bypass and output neutral must be connected to only one common point in the UPS. This neutral line must be grounded at the source. See **7.0 - Configuring Your Neutral and Ground Connections**.

4. For battery cabinets: DC power cables and ground from battery cabinet to UPS module and between battery cabinets. Observe polarity. When multiple conduits are used, an equal number of positive and negative cables should be contained in each conduit.



### NOTE

*DC power and battery circuit breaker control cables are provided with Liebert battery cabinets for use between multiple cabinets when bolted together. Power cables are sized for interconnecting battery cabinets. Battery cabinets specified for bolting up to the UPS are shipped with power cables to connect the battery cabinet system to the UPS module. Field-supplied cabling must be provided to connect stand-alone battery cabinets to the UPS module. Connections from the final battery cabinet to the UPS are provided in the field.*



### WARNING

Do not make any connections between battery tiers in the battery cabinet. These connections will be made by the Liebert Global Services representative during start-up.

5. For remote battery: DC power cables (and ground) from battery to Module Battery Disconnect, and then to UPS Module DC bus. Observe polarity. DC power cables should be installed in conduit with conductors in matched pairs (positive and negative).
6. Module Battery Disconnect control wiring to UPS module (and between battery cabinets, if applicable).
7. Control wiring to the optional Remote Monitor Panel, if used. Selected alarm messages are also available for customer use through a set of contacts on an optional separate terminal board. Wiring must be run in individual separate steel conduit.
8. Emergency Power Off control wiring must be run in separate steel conduit.
9. Communications wiring for optional site monitoring or modem must be run in separate steel conduit.
10. Power and control connections required for the Maintenance Bypass.
11. Any additional special wiring required at your site.



## 10.0 WIRING INSPECTION

1. Verify all power connections are tightened per the torque specifications in **Table 3**.
2. Verify all control wire terminations are tight.
3. Verify all power wires and connections have proper spacing between exposed surfaces, phase-to-phase and phase-to-ground.
4. Verify that all control wires are run in steel conduit, separate from all power wiring.

**Table 2 Power wiring terminals, factory supplied**

UPS Module Rating	Connection Type
300-450kVA	Busbars for connecting hardware are provided for all power wiring terminations. Each busbar has three pairs of holes, 0.562" diameter, on 1.75" centers. Field-supplied lugs are required.

Use 75°C copper wire. Select wire size based on the ampacities in **Table 5** of this manual, a reprint of Table 310-16 and associated notes of the National Electrical Code (NFPA 70).

Use commercially available solderless lugs for the wire size required for your application. Refer to **Table 4**. Connect wire to the lug using tools and procedures specified by the lug manufacturer.

**Table 3 Torque specifications**

NUT AND BOLT COMBINATIONS				
Bolt Shaft Size	Grade 2 Standard		Electrical Connections with Belleville Washers	
	Lb-in	N-m	Lb-in	N-m
1/4	53	6.0	46	5.2
5/16	107	12	60	6.8
3/8	192	22	95	11
1/2	428	22	256	29

CIRCUIT BREAKERS WITH COMPRESSION LUGS (FOR POWER WIRING)		
Wire Size or Range	Lb-in	N-m
#6 - #4	100	11
#3 - #1	125	14
1/0 - 2/0	150	17
3/0 - 200 MCM	200	23
250 - 400 MCM	250	28
500 - 700 MCM	300	34

CIRCUIT BREAKERS WITH COMPRESSION LUGS (FOR POWER WIRING)		
Current Rating	Lb-in	N-m
400 - 1200 Amps	300.00	34.00

TERMINAL BLOCK COMPRESSION LUGS (FOR CONTROL WIRING)		
AWG Wire Size or Range	Lb-in	N-m
#22 - #14	3.5 to 5.3	0.4 to 0.6

**NOTE:** Use the values in this table unless the equipment is labeled with a different torque value.

**Table 4** Field-supplied lugs

One-Hole Lugs						
	T & B <sup>1</sup> Lug Style	Wire Size	Bolt Size (in.)	Tongue Width (in.)	T & B <sup>1</sup> P/N	Liebert P/N
1	Stak-On	#1 AWG	3/8	0.76	H973	12-714255-46
2		1/0 AWG	3/8	0.88	J973	12-714255-56
3		2/0 AWG	3/8	1.00	K973	12-714255-66
4		3/0 AWG	3/8	1.10	L973	12-714255-76
5		4/0 AWG	3/8	1.20	M973	12-714255-86
6	Color-Keyed Aluminum/ Copper	#1 AWG	3/8	0.75	60124	—
7		1/0 AWG	3/8	0.88	60130	—
8		2/0 AWG	3/8	0.97	60136	—
9		3/0 AWG	3/8	1.06	60142	—
10	Color-Keyed Copper Cable Long Barrel	#1 AWG	5/16	0.67	54947BE	—
11		1/0 AWG	3/8	0.75	54909BE	—
12		2/0 AWG	3/8	0.81	54910BE	—
13		3/0 AWG	1/2	0.94	54965BE	—
14		4/0 AWG	1/2	1.03	54970BE	—
15		250 MCM	1/2	1.09	54913BE	—
16	Narrow-Tongue Copper Cable	350 MCM	1/2	1.09	55165	—
17		500 MCM	1/2	1.20	55171	—

1. Manufacturer: Thomas & Betts (T & B), 1-800-862-8324

**Table 5 Table 310-16, National Electrical Code (Reprint)**

**Allowable Ampacities of Insulated Conductors Rated 0-2000 Volts, 60° to 90°C (140° to 194°F) <sup>1</sup>**

Not More Than Three Conductors in Raceway or Cable or Earth (Directly Buried), Based on Ambient Temperature of 30°C (86°F)

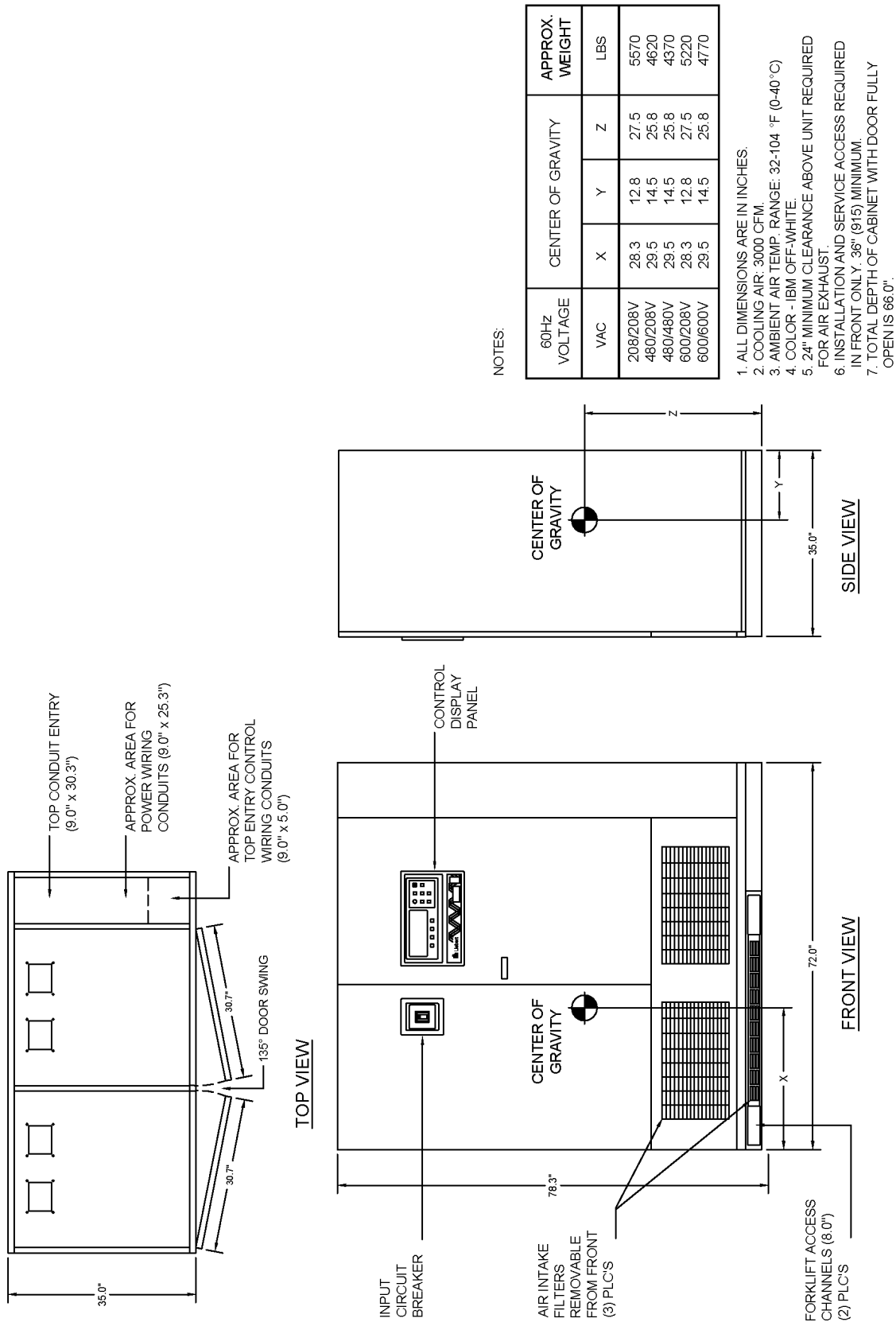
SIZE	TEMPERATURE RATING OF CONDUCTOR. SEE TABLE 310-13.						SIZE
	60°C (140°F)	75°C (167°F)	90°C (194°F)	60°C (140°F)	75°C (167°F)	90°C (194°F)	
	TYPES TW= UF=	TYPES FEPW= RH, RHW= THHW= THW= THWN= XHHW= USE= ZW=	TYPES TBS, SA, SIS, FEP= FEPB=, MI, RHH= RHW-2 THHN=, THHW= THW-2, THWN-2, USE-2, XHH, XHHW= XHHW-2, ZW-2	TYPES TW= UF=	TYPES RH=, RHW= THHW= THW= THWN= XHHW= USE=	TYPES TBS, SA, SIS, THHN= THHW= THW-2, THWN-2, RHH=, RHW-2, USE-2, XHH, XHHW= XHHW-2, ZW-2	
AWG kcmil	COPPER			ALUMINUM OR COPPER-CLAD ALUMINUM			AWG kcmil
18	.....	.....	14	.....	.....	.....	.....
16	.....	.....	18	.....	.....	.....	.....
14*	20	20	25	.....	.....	.....	.....
12*	25	25	30	20	20	25	12*
10*	30	35	40	25	30	35	10*
8	40	50	55	30	40	45	8*
6	55	65	75	40	50	60	6
4	70	85	95	55	65	75	4
3	85	100	110	65	75	85	3
2	95	115	130	75	90	100	2
1	110	130	150	85	100	115	1
1/0	125	150	170	100	120	135	1/0
2/0	145	175	195	115	135	150	2/0
3/0	165	200	225	130	155	175	3/0
4/0	195	230	260	150	180	205	4/0
250	215	255	290	170	205	230	250
300	240	285	320	190	230	255	300
350	260	310	350	210	250	280	350
400	280	335	380	225	270	305	400
500	320	380	430	260	310	350	500
600	355	420	475	285	340	385	600
700	385	460	520	310	375	420	700
750	400	475	535	320	385	435	750
800	410	490	555	330	395	450	800
900	435	520	585	355	425	480	900
1000	455	545	615	375	445	500	1000
1250	495	590	665	405	485	545	1250
1500	520	625	705	435	520	585	1500
1750	545	650	735	455	545	615	1750
2000	560	665	750	470	560	630	2000
CORRECTION FACTORS							
Ambient Temp °C	For ambient temperatures other than 30°C (86°F), multiply the allowable ampacities shown above by the appropriate factor shown below.						Ambient Temp °F
21-25	1.08	1.05	1.04	1.08	1.05	1.04	70-77
26-30	1.00	1.00	1.00	1.00	1.00	1.00	78-86
31-35	.91	.94	.96	.91	.94	.96	87-95
36-40	.82	.88	.91	.82	.88	.91	96-104
41-45	.71	.82	.87	.71	.82	.87	105-113
46-50	.58	.75	.82	.58	.75	.82	114-122
51-55	.41	.67	.76	.41	.67	.76	123-131
56-60	.....	.58	.71	.....	.58	.71	132-140
61-70	.....	.33	.58	.....	.33	.58	141-158
71-80	.....	.....	.41	.....	.....	.41	159-176

\* Unless otherwise specifically permitted in Section 240-3 of this Code, the overcurrent protection for conductor types marked with an asterisk (\*) shall not exceed 15 amperes for No. 14, 20 amperes for No. 12, and 30 amperes for No. 10 copper; or 15 amperes for No. 12 and 25 amperes for No. 10 aluminum and copper-clad aluminum after any correction factors for ambient temperature and number of conductors have been applied.

1. Reprinted with permission from NEC 1999, NFPA 70, the *National Electrical Code*<sup>®</sup>, Copyright 1998, National Fire Protection Association, Quincy, MA 02269. This reprinted material is not the complete and official position of the National Fire Protection Association, on the referenced subject which is represented only by the standard in its entirety.

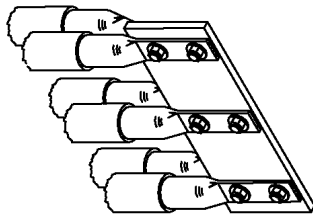
# 11.0 INSTALLATION DRAWINGS

Figure 10 Outline drawing, 300kVA Single-Module UPS

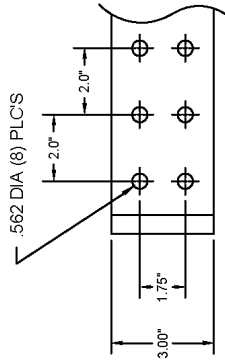


88-797638-64  
Rev. 07

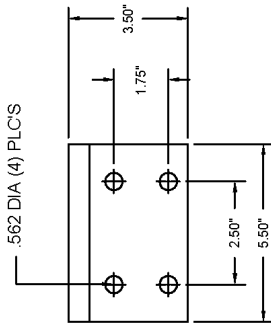
Figure 11 Terminal details, 300kVA Single-Module UPS



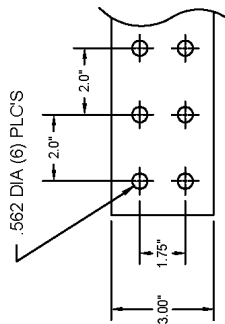
TYPICAL DETAIL OF CUSTOMER CONNECTION TO BUS BAR



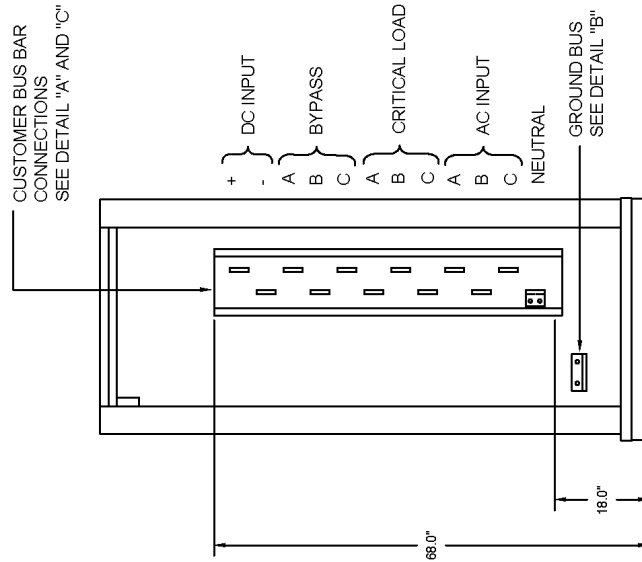
BUS BAR NEUTRAL DETAIL "C"



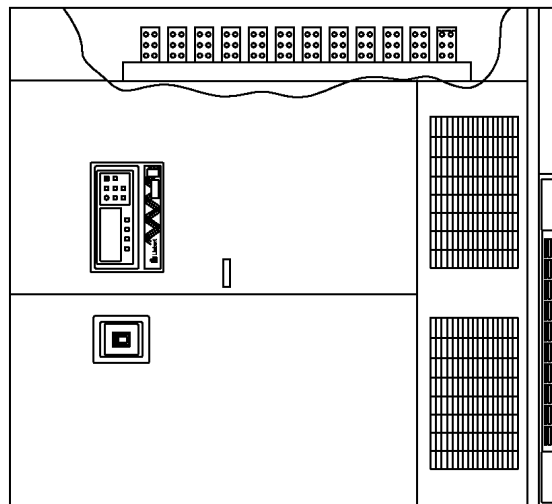
GROUND BUS DETAIL "B"



BUS BAR DETAIL "A"



SIDE VIEW



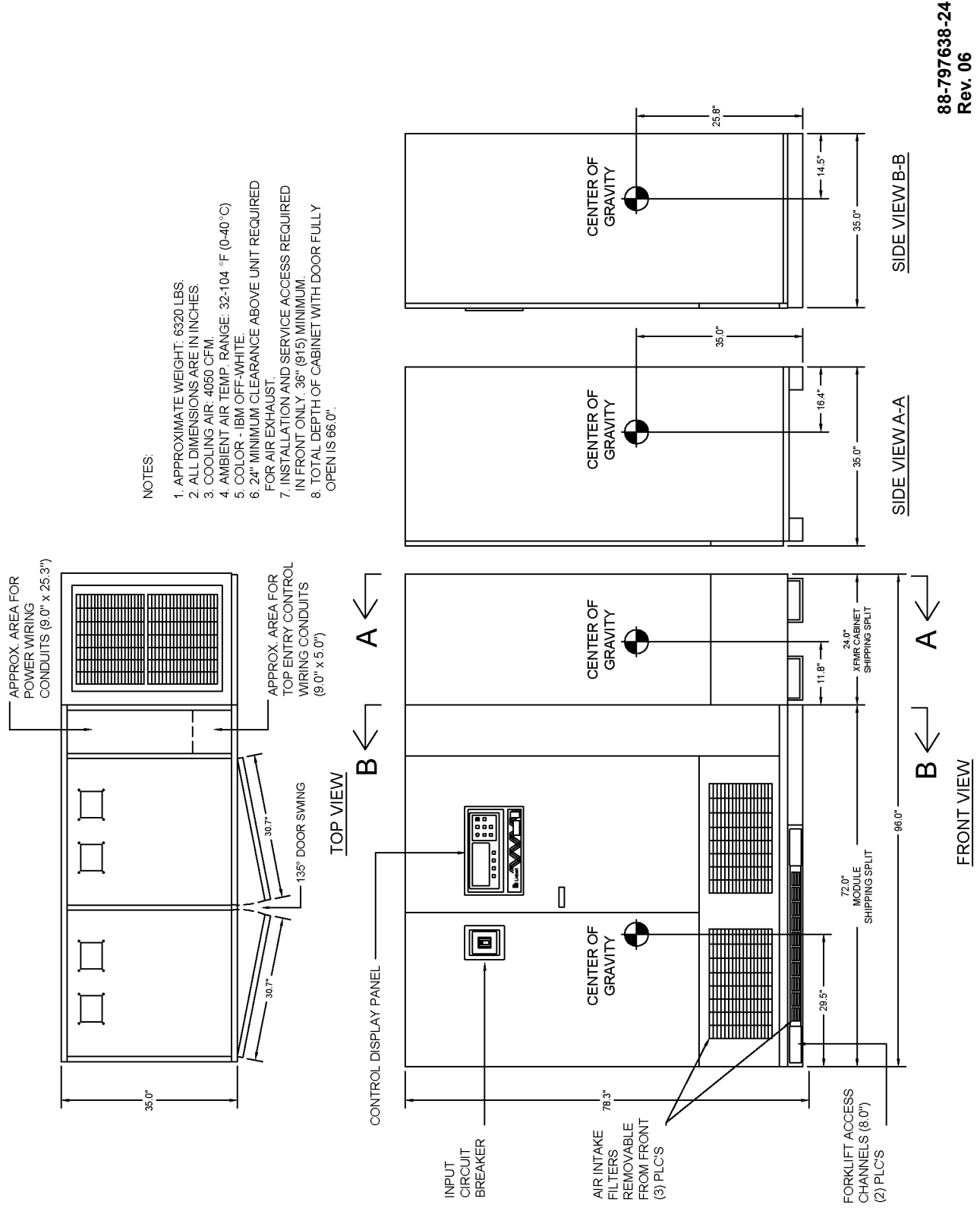
FRONT VIEW

NOTES:

1. LUGS FOR BUS BAR CONNECTION, PROVIDED BY OTHERS.
2. ALL DIMENSIONS ARE IN INCHES.

88-797638-73  
Rev. 08

Figure 12 Outline drawing, 300kVA Single-Module UPS with input ISO transformer cabinet (optional)



- NOTES:
1. APPROXIMATE WEIGHT: 6320 LBS.
  2. ALL DIMENSIONS ARE IN INCHES.
  3. COOLING AIR: 4050 CFM
  4. AMBIENT AIR TEMP. RANGE: 32-104 °F (0-40 °C)
  5. COLOR - IBM OFF-WHITE.
  6. 24" MINIMUM CLEARANCE ABOVE UNIT REQUIRED FOR AIR EXHAUST.
  7. INSTALLATION AND SERVICE ACCESS REQUIRED IN FRONT ONLY. 36" (915) MINIMUM.
  8. TOTAL DEPTH OF CABINET WITH DOOR FULLY OPEN IS 66.0".

88-797638-24  
Rev. 06

Figure 13 Terminal details, 300kVA Single-Module UPS with input ISO transformer cabinet (optional)

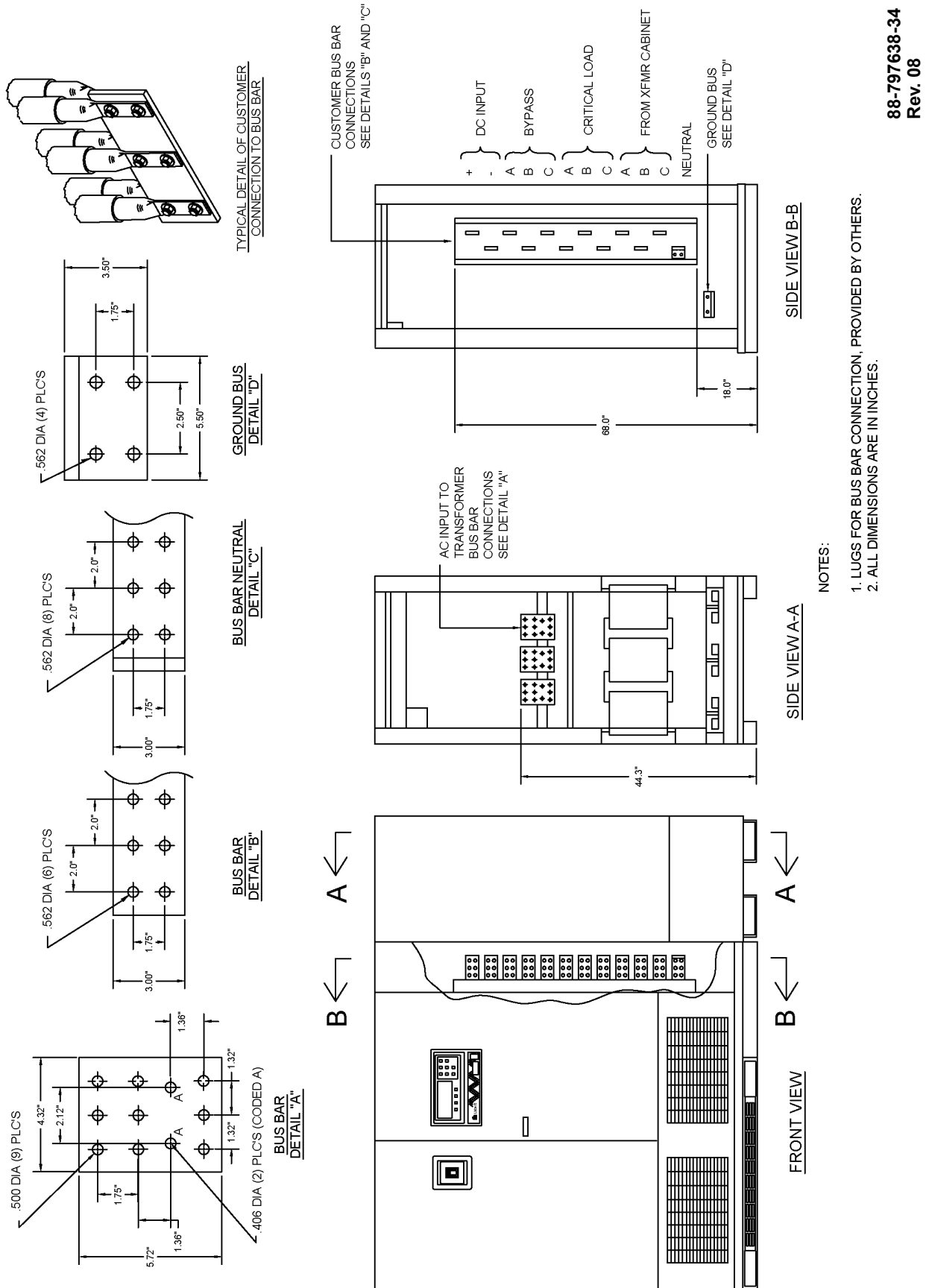
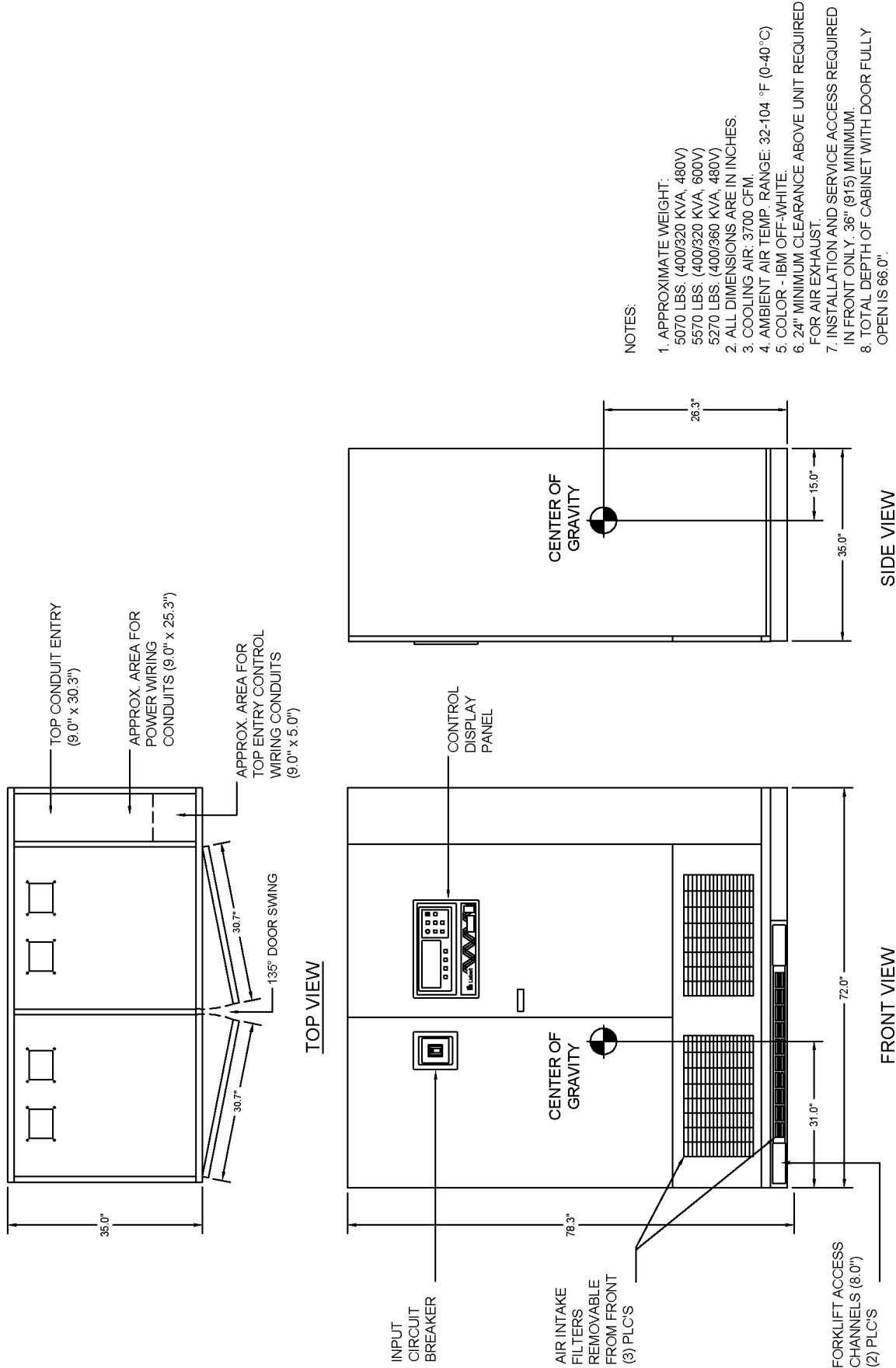


Figure 14 Outline drawing, 400kVA Single-Module UPS



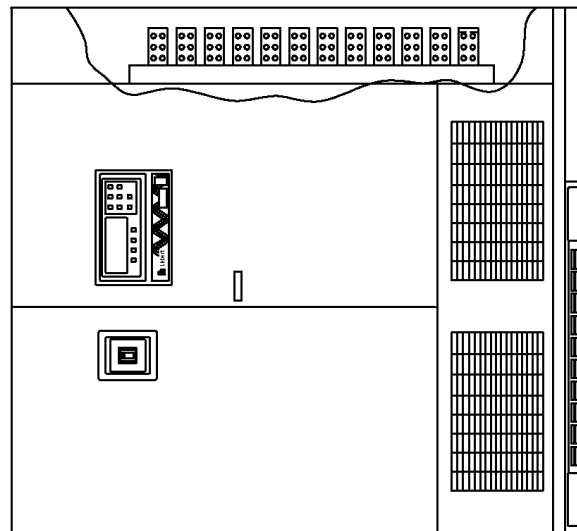
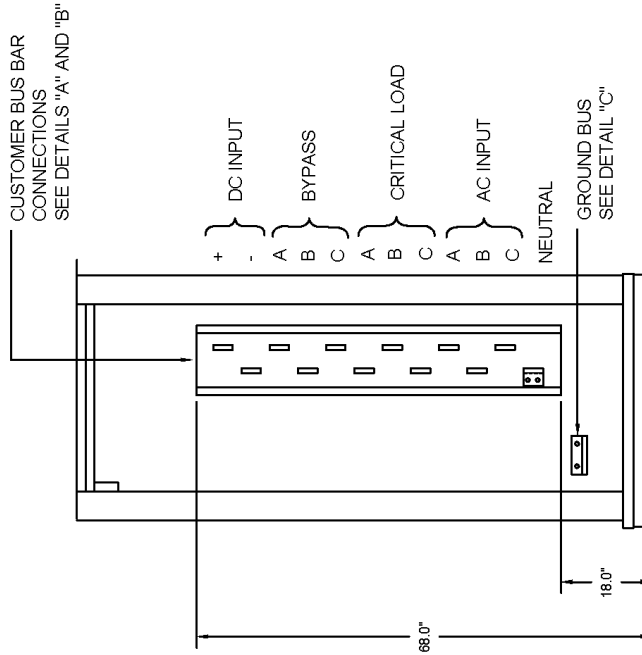
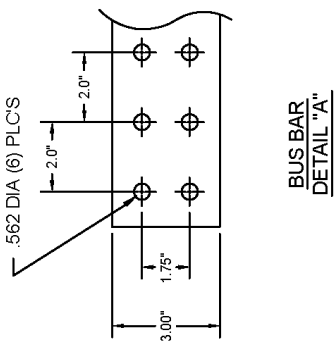
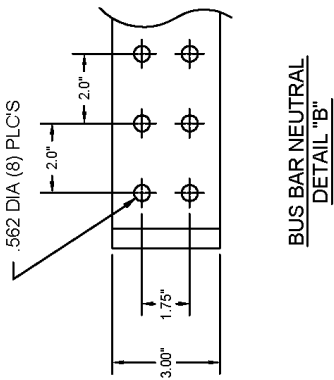
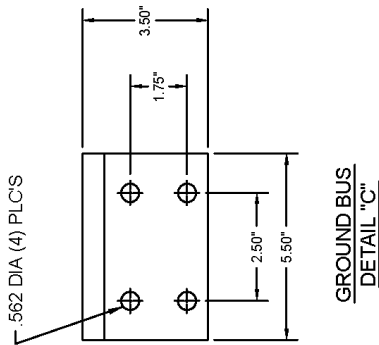
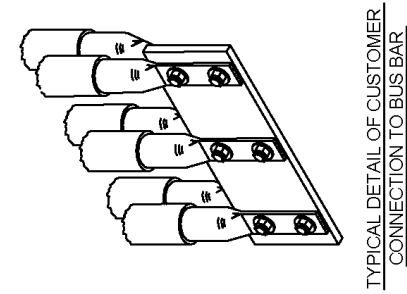
NOTES:

1. APPROXIMATE WEIGHT:  
 5070 LBS. (400/320 KVA, 480V)  
 5570 LBS. (400/320 KVA, 600V)  
 5270 LBS. (400/360 KVA, 480V)
2. ALL DIMENSIONS ARE IN INCHES.
3. COOLING AIR: 3700 CFM.
4. AMBIENT AIR TEMP. RANGE: 32-104 °F (0-40 °C)
5. COLOR - IBM OFF-WHITE.
6. 24" MINIMUM CLEARANCE ABOVE UNIT REQUIRED FOR AIR EXHAUST.
7. INSTALLATION AND SERVICE ACCESS REQUIRED IN FRONT ONLY. 36" (915) MINIMUM.
8. TOTAL DEPTH OF CABINET WITH DOOR FULLY OPEN IS 86.0".

88-797648-64  
Rev. 07



Figure 15 Terminal details, 400kVA Single-Module UPS



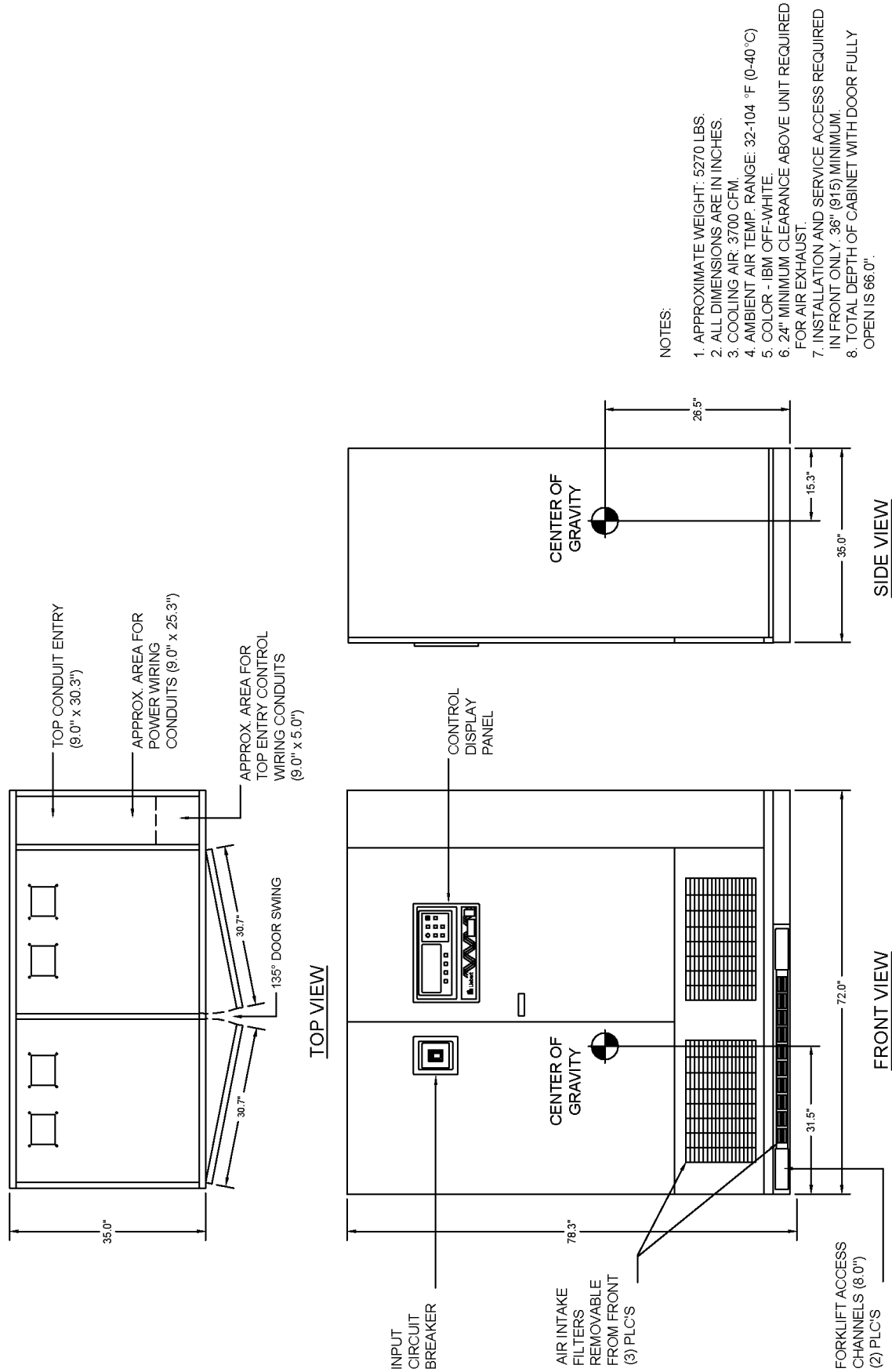
SIDE VIEW

NOTES:

1. LUGS FOR BUS BAR CONNECTION, PROVIDED BY OTHERS.
2. ALL DIMENSIONS ARE IN INCHES.

88-797648-74  
Rev. 07

Figure 16 Outline drawing, 450kVA Single-Module UPS, 480V input, 480V output

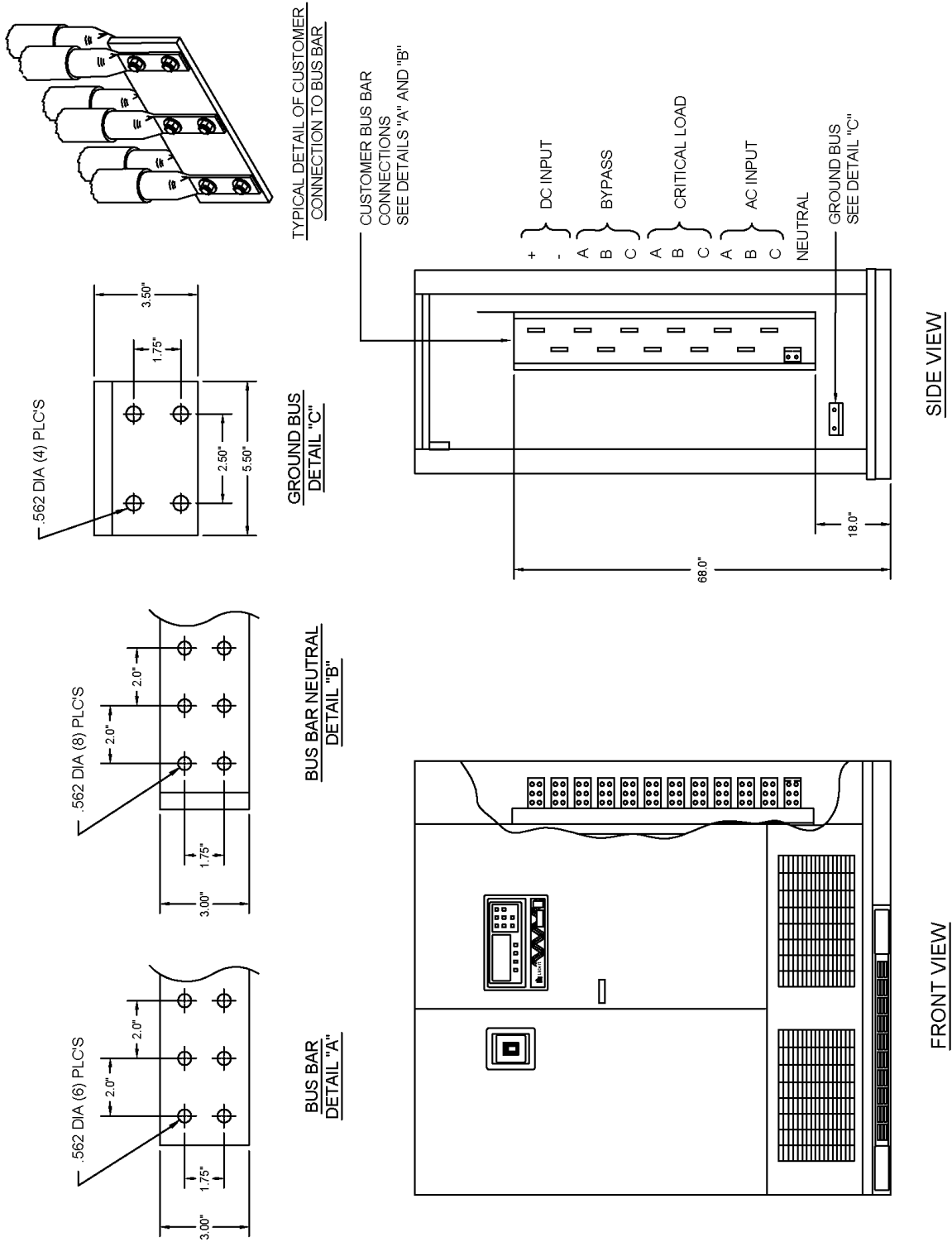


NOTES:

1. APPROXIMATE WEIGHT: 5270 LBS.
2. ALL DIMENSIONS ARE IN INCHES.
3. COOLING AIR: 3700 CFM.
4. AMBIENT AIR TEMP. RANGE: 32-104 °F (0-40 °C)
5. COLOR - IBM OFF-WHITE.
6. 24" MINIMUM CLEARANCE ABOVE UNIT REQUIRED FOR AIR EXHAUST.
7. INSTALLATION AND SERVICE ACCESS REQUIRED IN FRONT ONLY. 36" (915) MINIMUM.
8. TOTAL DEPTH OF CABINET WITH DOOR FULLY OPEN IS 66.0".

88-797655-64  
Rev. 07

Figure 17 Terminal details, 450kVA Single-Module UPS, 480V input, 480/277V output



NOTES:

1. LUGS FOR BUS BAR CONNECTION, PROVIDED BY OTHERS.
2. ALL DIMENSIONS ARE IN INCHES.

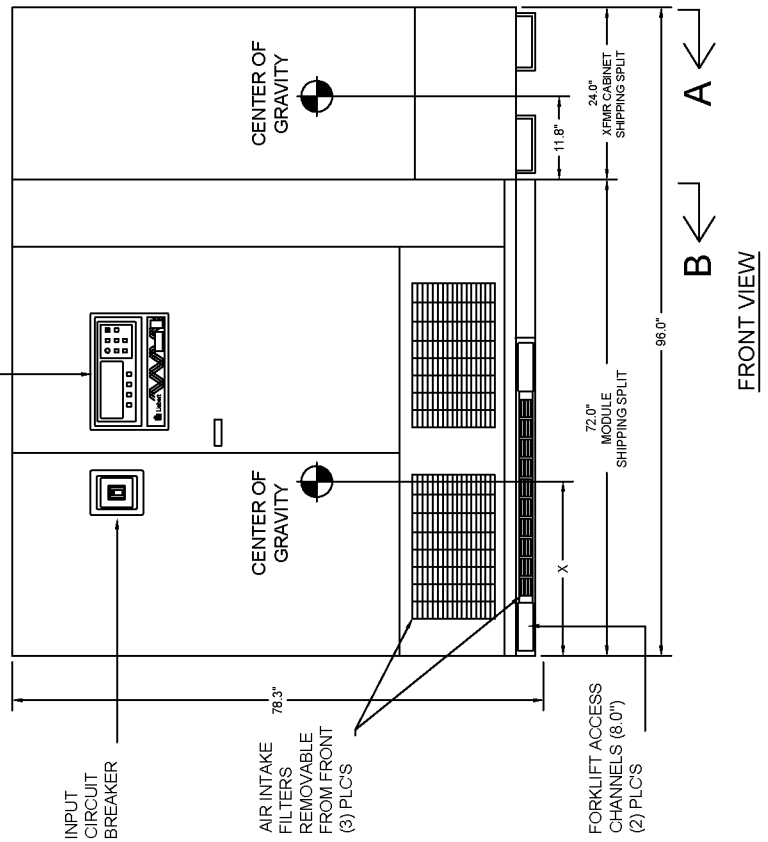
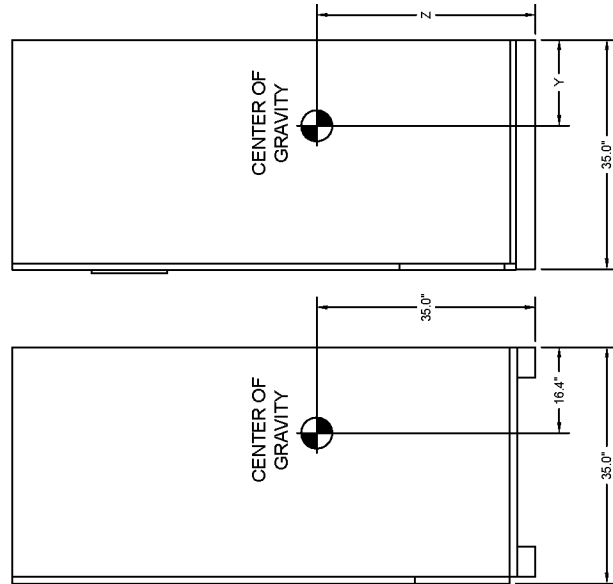
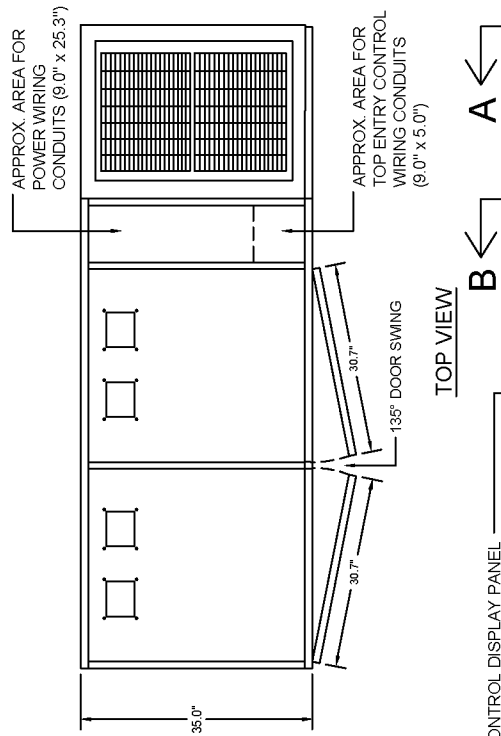
88-797655-74  
Rev. 07

Figure 18 Outline drawing, 400 & 450kVA Single-Module UPS with input ISO transformer cabinet (optional)

NOTES:

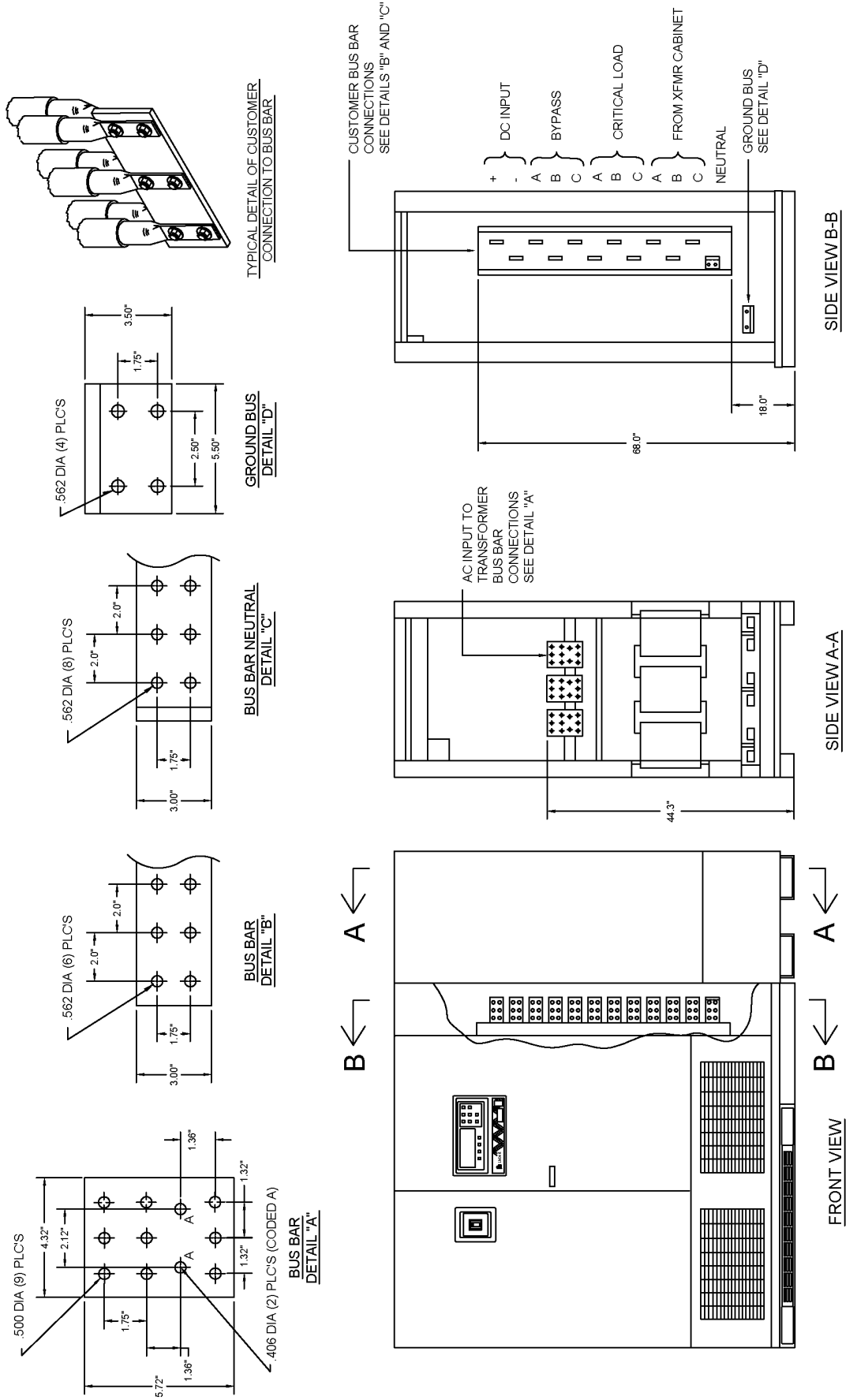
POWER RATING	VOLTAGE	CENTER OF GRAVITY			APPROX. WEIGHT
KVA/KW	VAC	X	Y	Z	LBS
400/320	480	31.0	15.0	26.3	7220
400/360	600	31.0	15.0	26.3	7720
450/360	480	31.5	15.3	26.5	7670

1. ALL DIMENSIONS ARE IN INCHES.
2. COOLING AIR: 4750 CFM.
3. AMBIENT AIR TEMP. RANGE: 32-104 °F (0-40 °C)
4. COLOR - IBM OFF-WHITE.
5. 24" MINIMUM CLEARANCE ABOVE UNIT REQUIRED FOR AIR EXHAUST.
6. INSTALLATION AND SERVICE ACCESS REQUIRED IN FRONT ONLY. 36" (915) MINIMUM.
7. TOTAL DEPTH OF CABINET WITH DOOR FULLY OPEN IS 66.0".



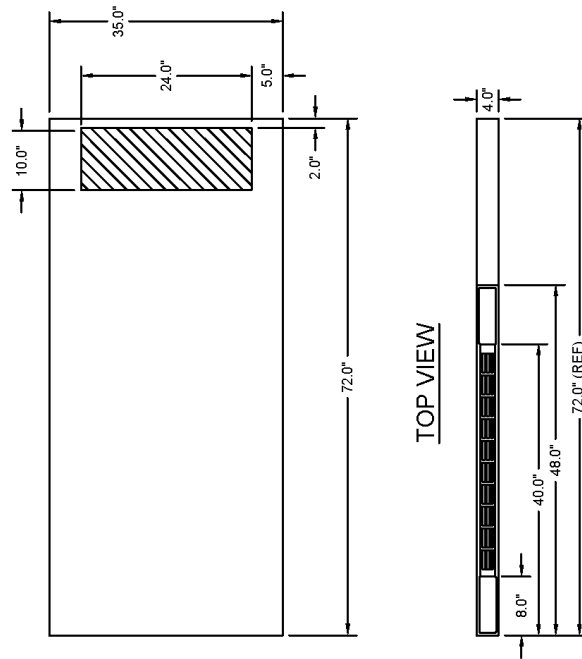
88-797655-24  
Rev. 08

Figure 19 Terminal details, 400 & 450kVA Single-Module UPS with input ISO transformer cabinet (optional)



- NOTES:
1. LUGS FOR BUS BAR CONNECTION, PROVIDED BY OTHERS.
  2. ALL DIMENSIONS ARE IN INCHES.
- 88-797655-34**  
**Rev. 09**

Figure 20 Base mounting patterns, 300-450kVA modules



FRONT VIEW OF BASE (FORKLIFT ACCESS)

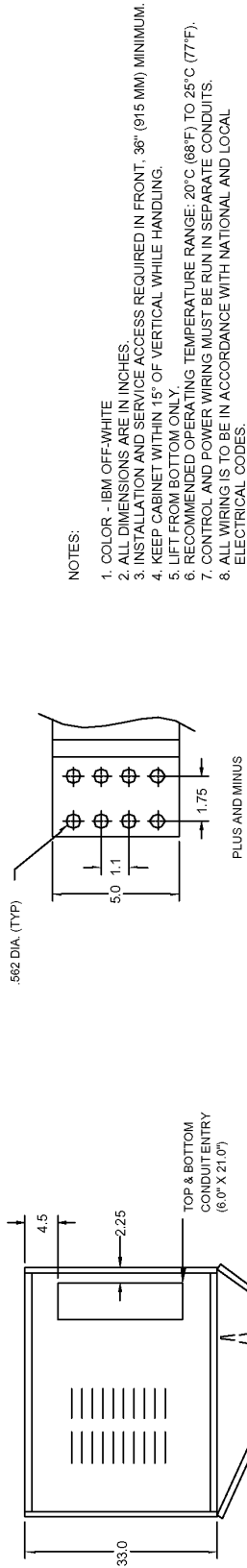
NOTES:

1. SHADED AREAS ON REMOVABLE PLATES INDICATE AVAILABLE LOCATIONS FOR BOTTOM ENTRY OF CUSTOMER CABLES IF DESIRED.
2. THE REMOVABLE PLATES SHOWN ARE LOCATED APPROXIMATELY 4.0 INCHES FROM THE CABINET BASE MOUNTING SURFACE (e.g. CONCRETE FLOOR).
3. TOLERANCE ON ALL DIMENSIONS IS  $\pm 0.25"$
4. ALL DIMENSIONS ARE IN INCHES.
5. ALL PATTERNS ARE TOP VIEW ONLY.

88-797613-15  
Rev. 10



Figure 22 Battery power pack, Size A

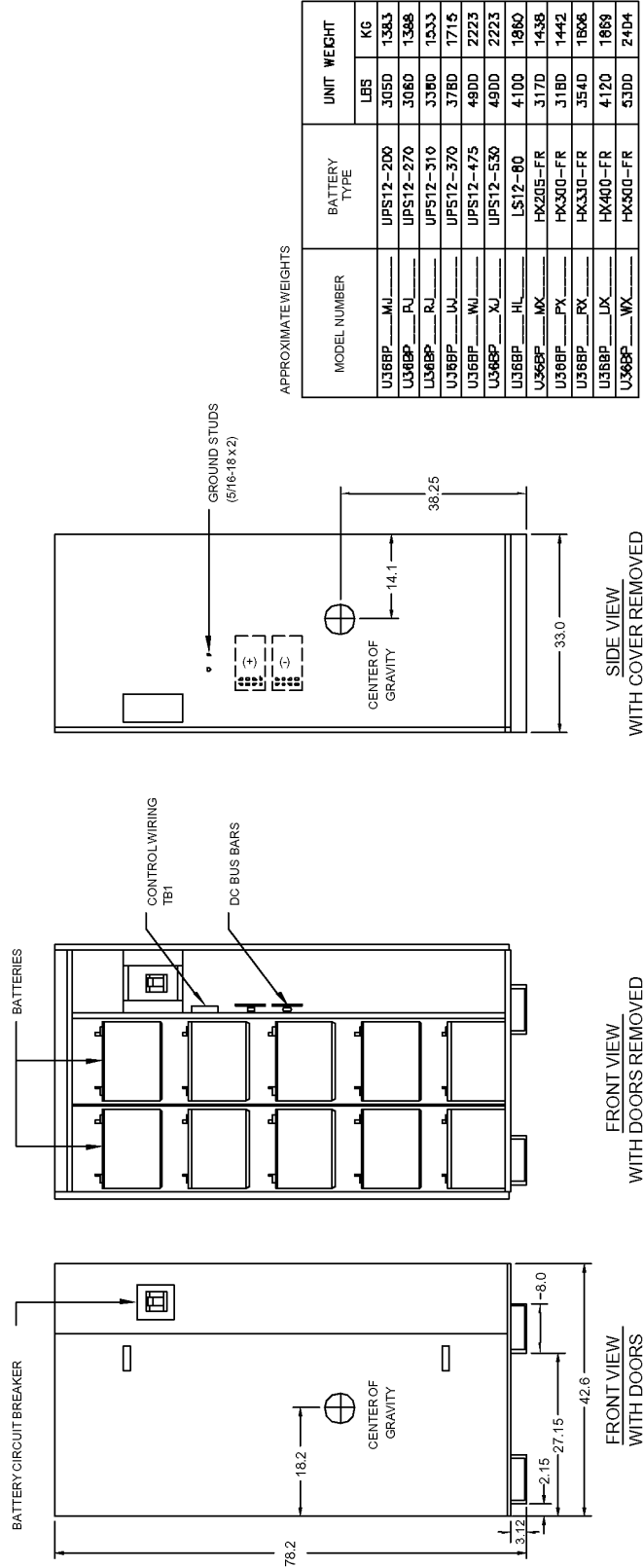


NOTES:

1. COLOR - IBM OFF-WHITE
2. ALL DIMENSIONS ARE IN INCHES.
3. INSTALLATION AND SERVICE ACCESS REQUIRED IN FRONT. .38" (915 MM) MINIMUM.
4. KEEP CABINET WITHIN 15° OF VERTICAL WHILE HANDLING.
5. LIFT FROM BOTTOM ONLY.
6. RECOMMENDED OPERATING TEMPERATURE RANGE: 20°C (68°F) TO 25°C (77°F).
7. CONTROL AND POWER WIRING MUST BE RUN IN SEPARATE CONDUITS.
8. ALL WIRING IS TO BE IN ACCORDANCE WITH NATIONAL AND LOCAL ELECTRICAL CODES.

DETAIL FOR DC BUS BARS

TOP VIEW



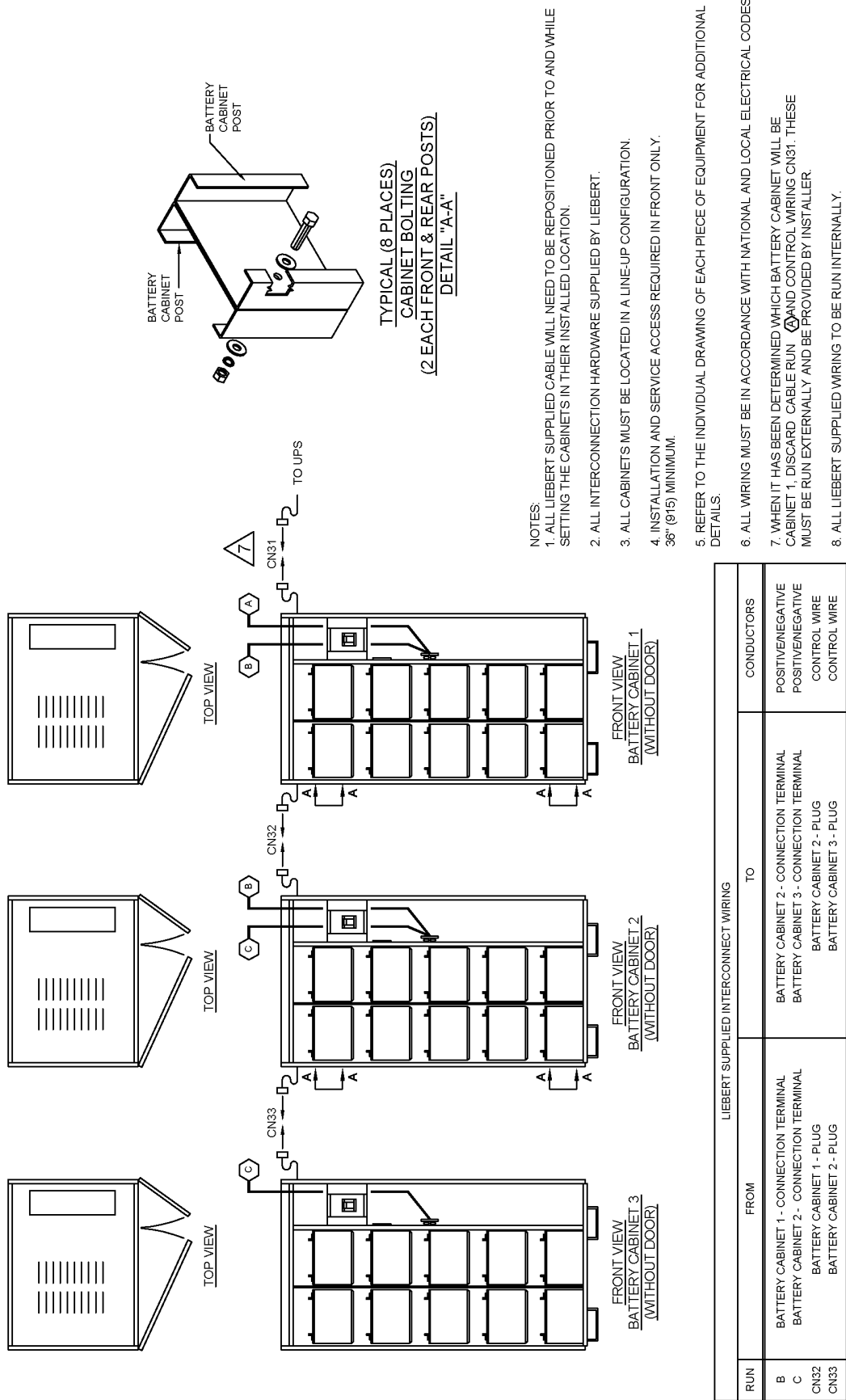
APPROXIMATE WEIGHTS

MODEL NUMBER	BATTERY TYPE	UNIT WEIGHT	
		LBS	KG
U36BP_MJ	UPS12-200	3050	1383
U36BP_RJ	UPS12-270	3060	1388
U36BP_RL	UP512-310	3380	1533
U36BP_RJ	UP512-370	3780	1715
U36BP_WJ	UP512-475	4900	2223
U36BP_XJ	UP512-530	4900	2223
U36BP_HL	L512-80	4100	1860
U36BP_NX	HX205-FR	3170	1438
U36BP_PX	HX300-FR	3180	1442
U36BP_RX	HX330-FR	3540	1606
U36BP_UX	HX400-FR	4120	1869
U36BP_WX	HX500-FR	5300	2404

88-797616-01  
Rev. 10

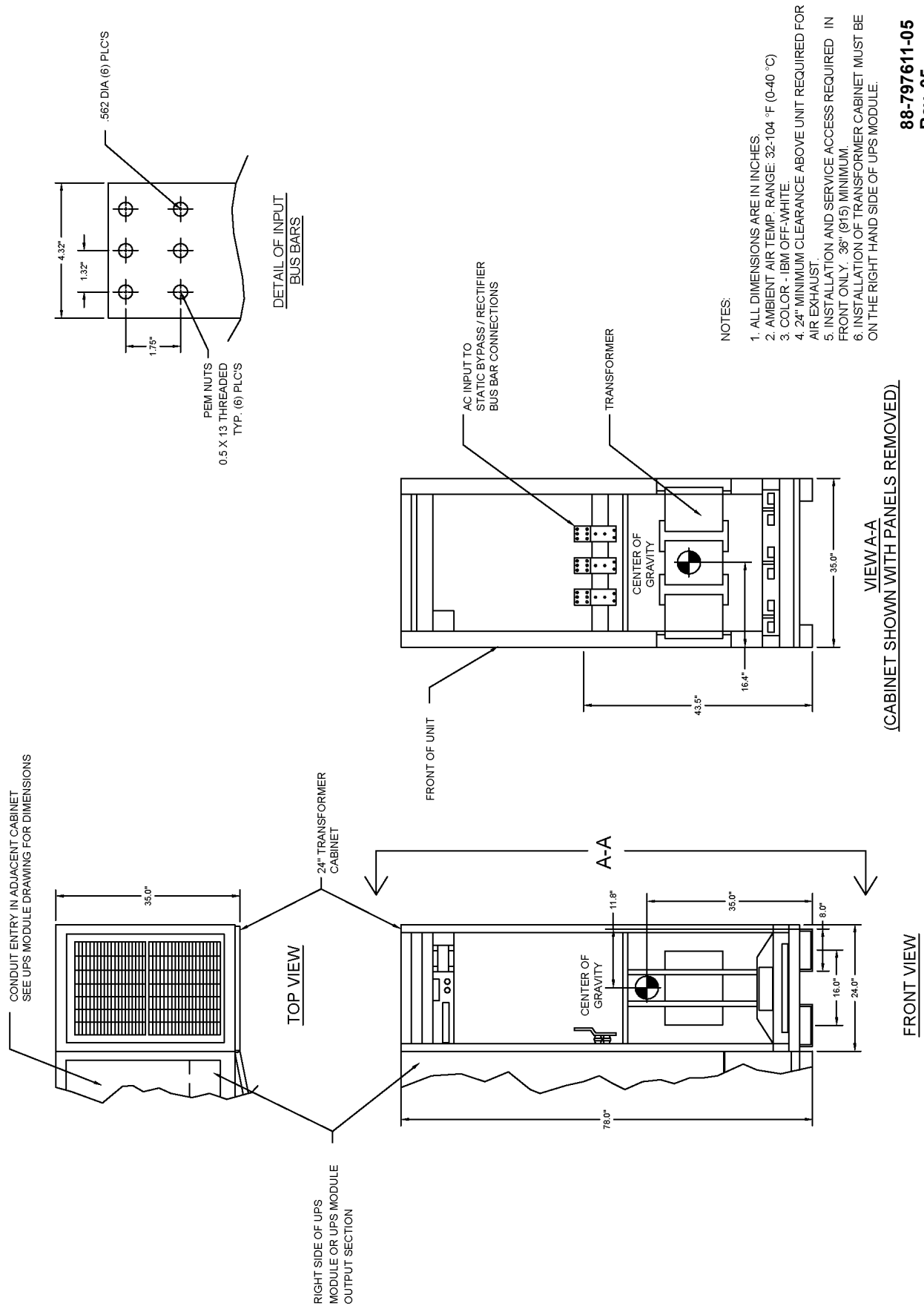


Figure 23 Line-up detail, 300-500kVA Single- or Multi-Module System with battery cabinets



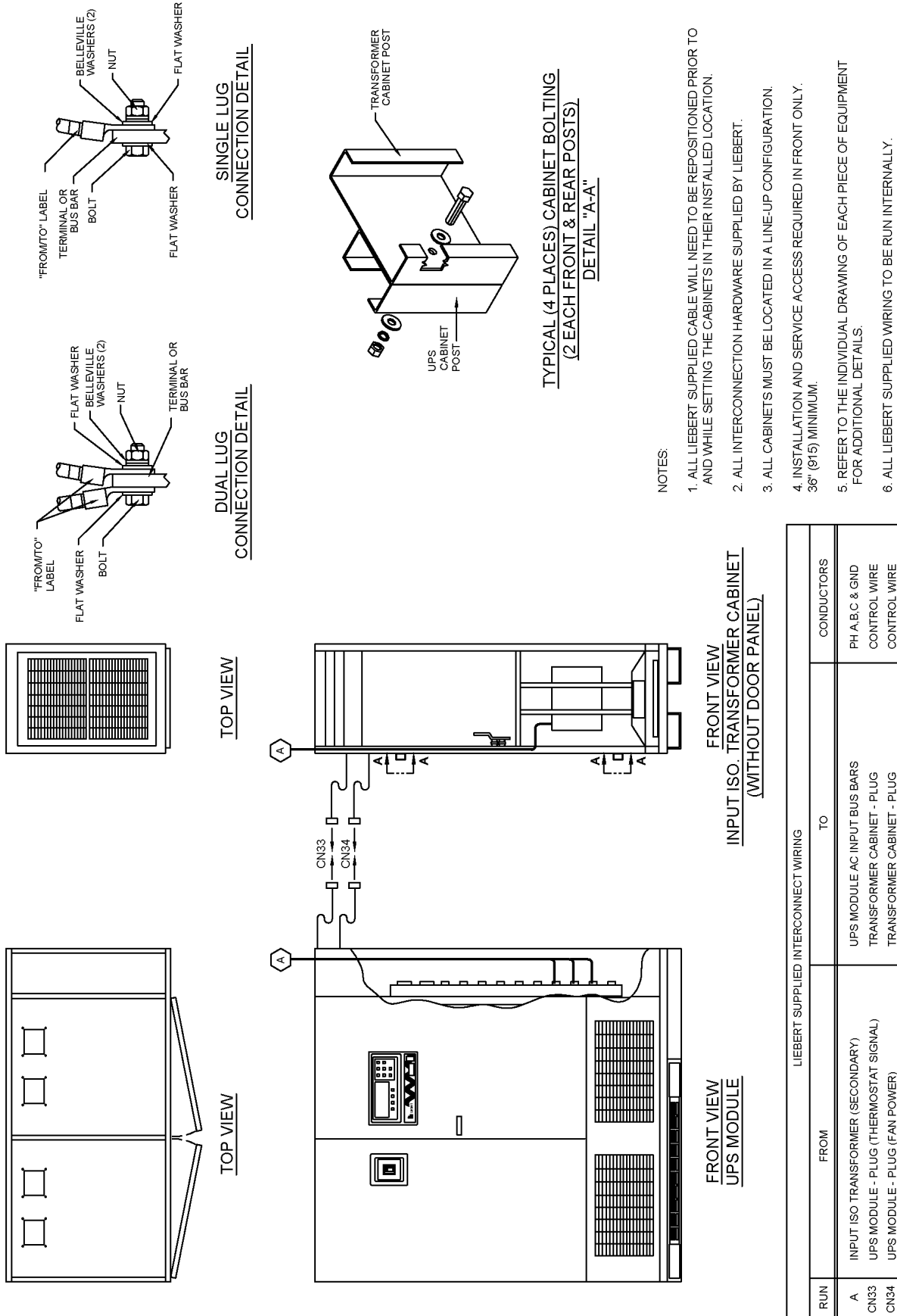
88-797607-63  
Rev. 04

Figure 24 Outline drawing, 300-450kVA, 24-in. Transformer Cabinet (optional)



88-797611-05  
 Rev. 05

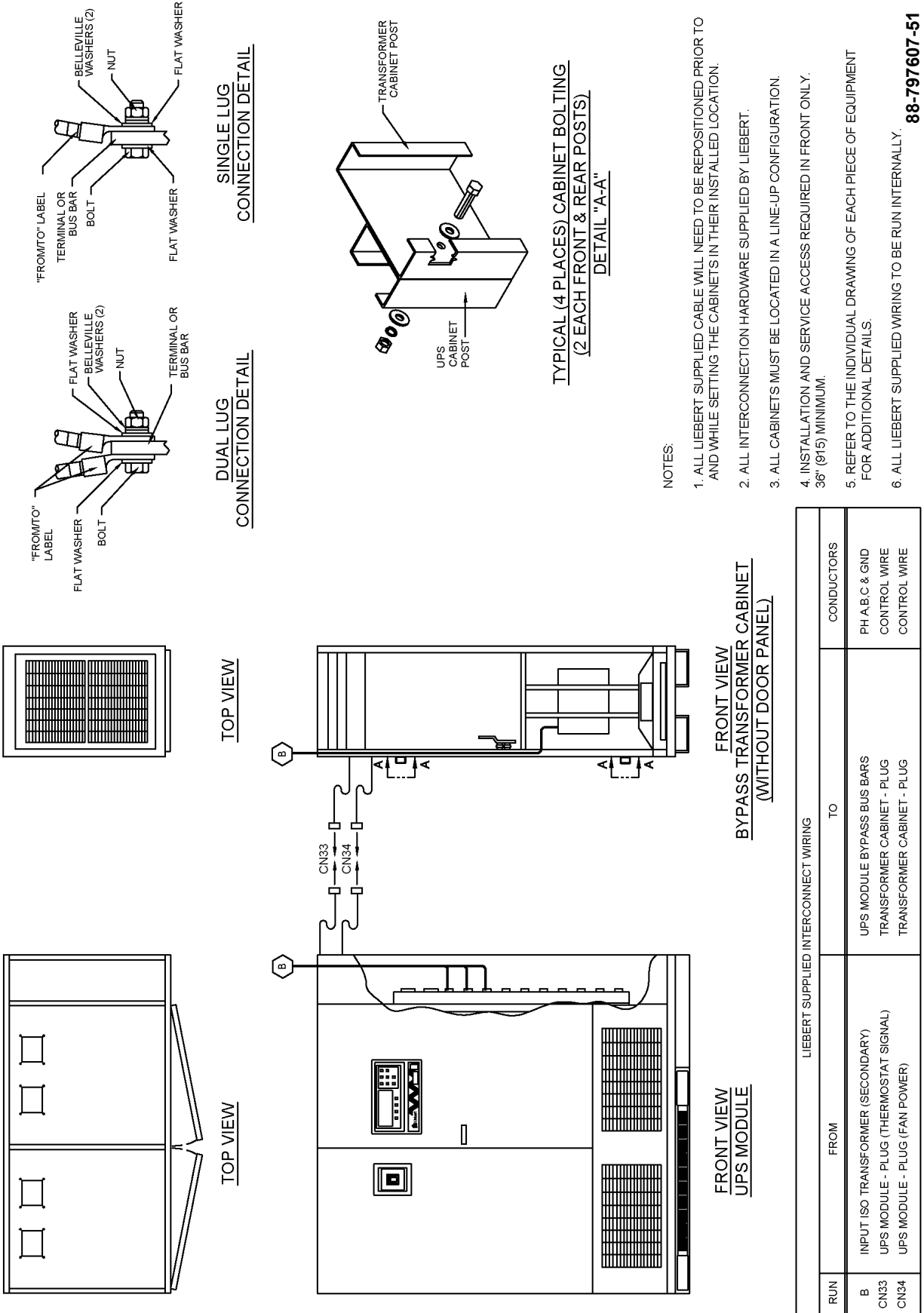
Figure 25 Line-up detail, 300-450kVA Single-Module System with input isolation transformer cabinet



88-797607-50  
Rev. 03

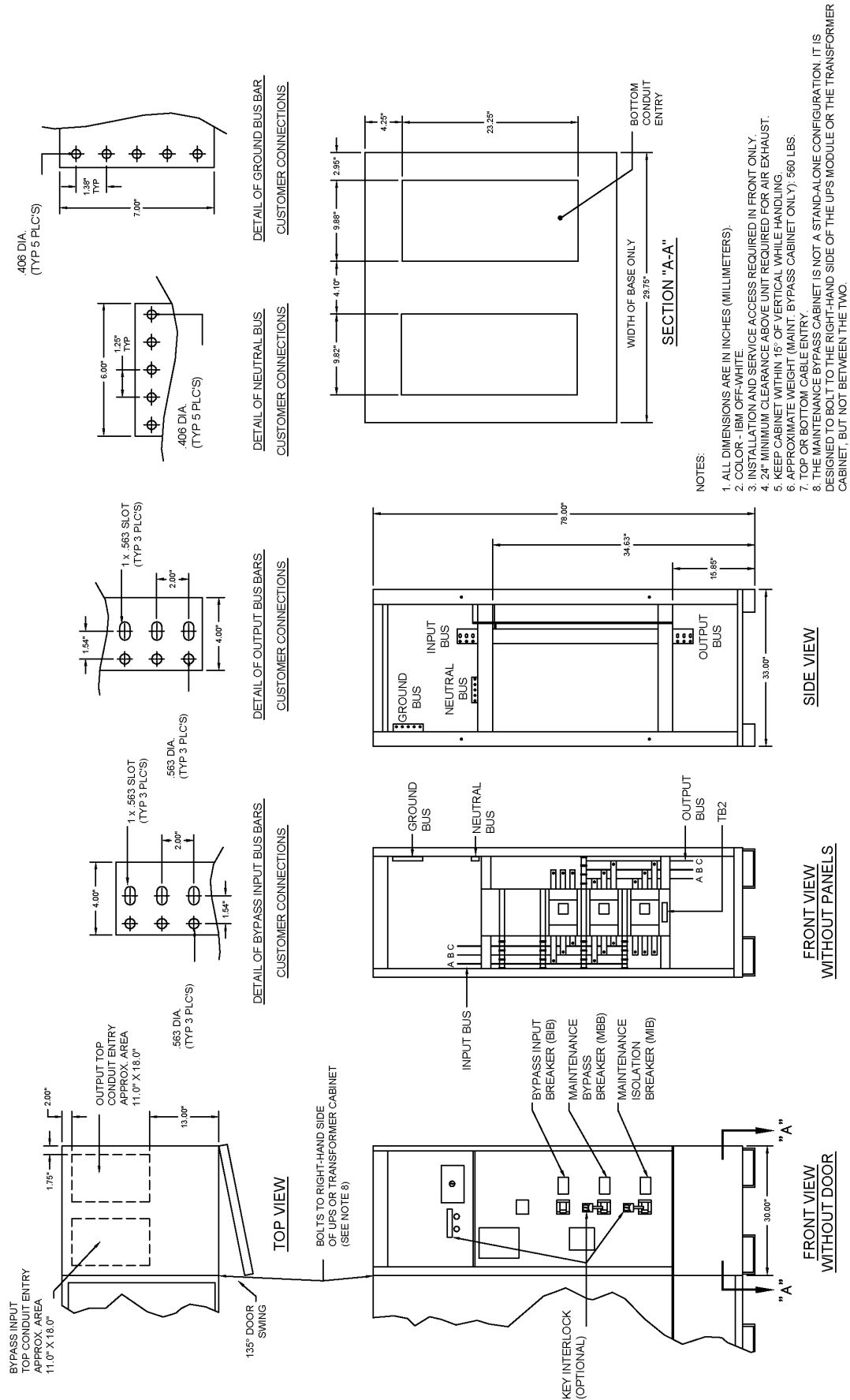
LIEBERT SUPPLIED INTERCONNECT WIRING		FROM	TO	CONDUCTORS
RUN	A	INPUT ISO TRANSFORMER (SECONDARY) UPS MODULE - PLUG (THERMOSTAT SIGNAL) UPS MODULE - PLUG (FAN POWER)	UPS MODULE AC INPUT BUS BARS TRANSFORMER CABINET - PLUG TRANSFORMER CABINET - PLUG	PH A, B, C & GND CONTROL WIRE CONTROL WIRE

Figure 26 Line-up detail, 300-400kVA Single-Module System with Bypass Transformer Cabinet



88-797607-51  
Rev. 03

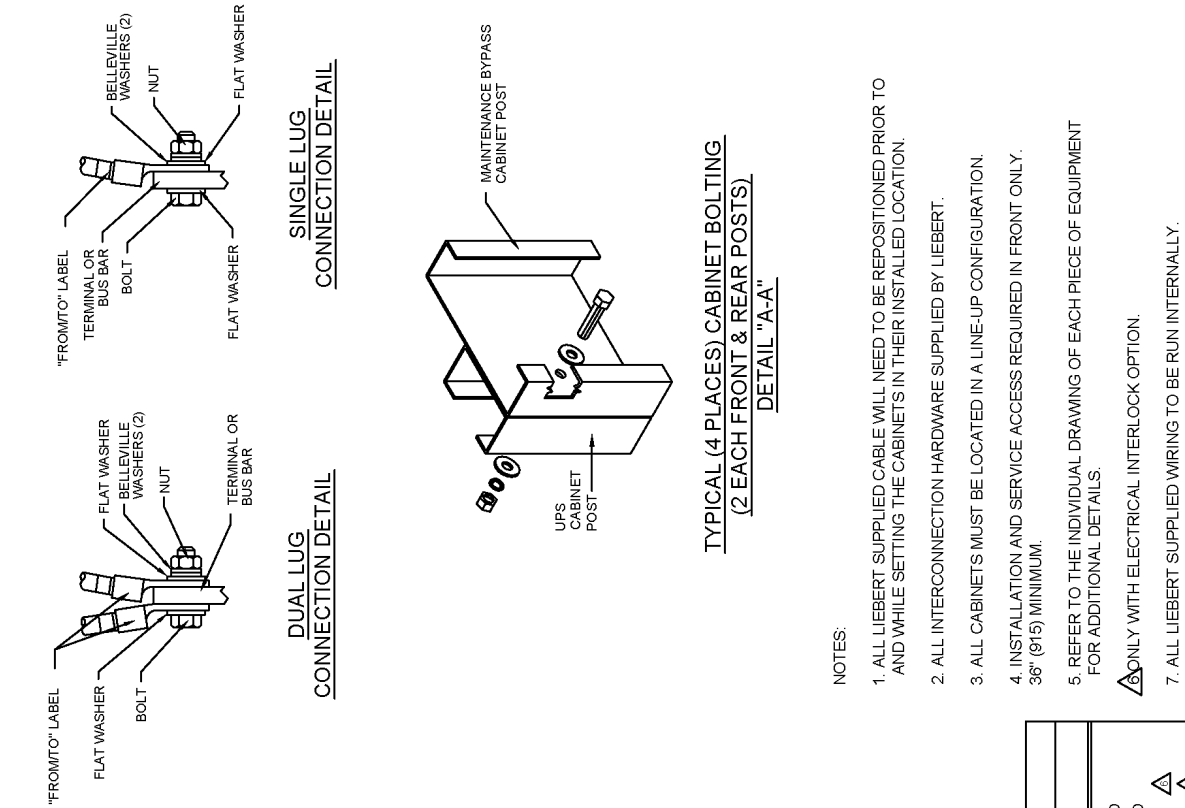
Figure 27 Outline drawing, 3-breaker Maintenance Bypass Cabinet, 125-400A



88-791615-28  
Rev. 06



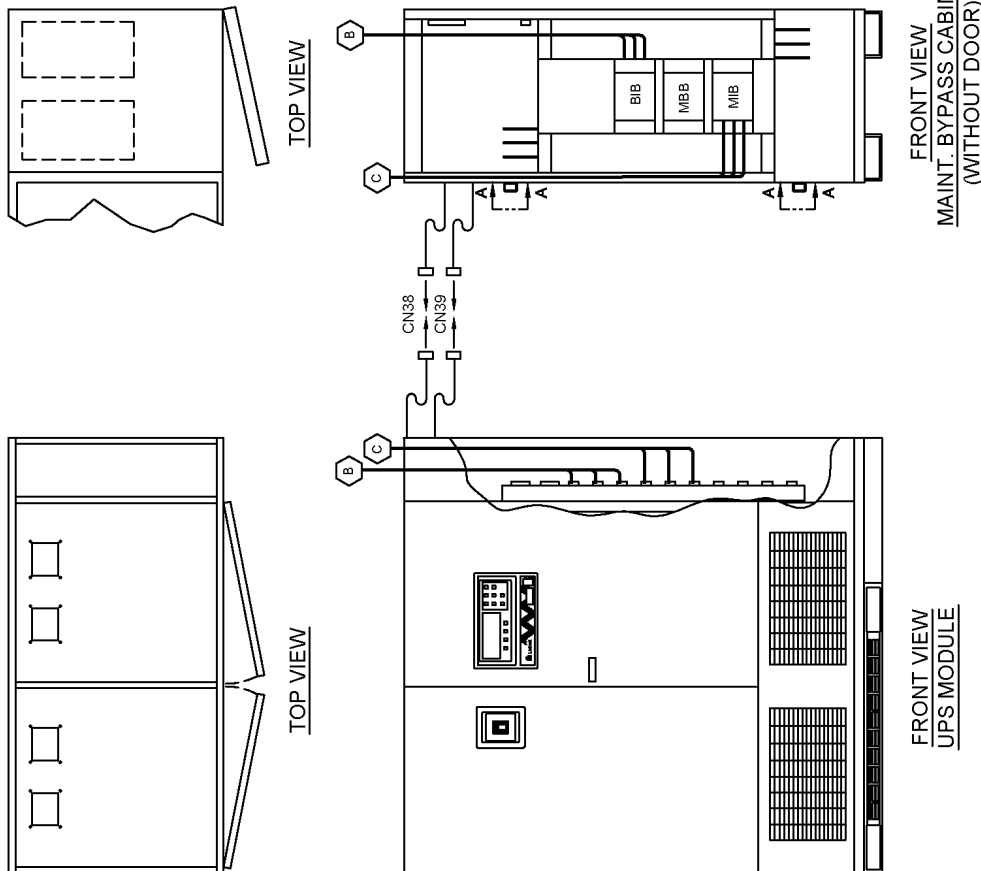
Figure 29 Line-up detail, 300-450kVA Single-Module System with 3-breaker Maintenance Bypass Cabinet



NOTES:

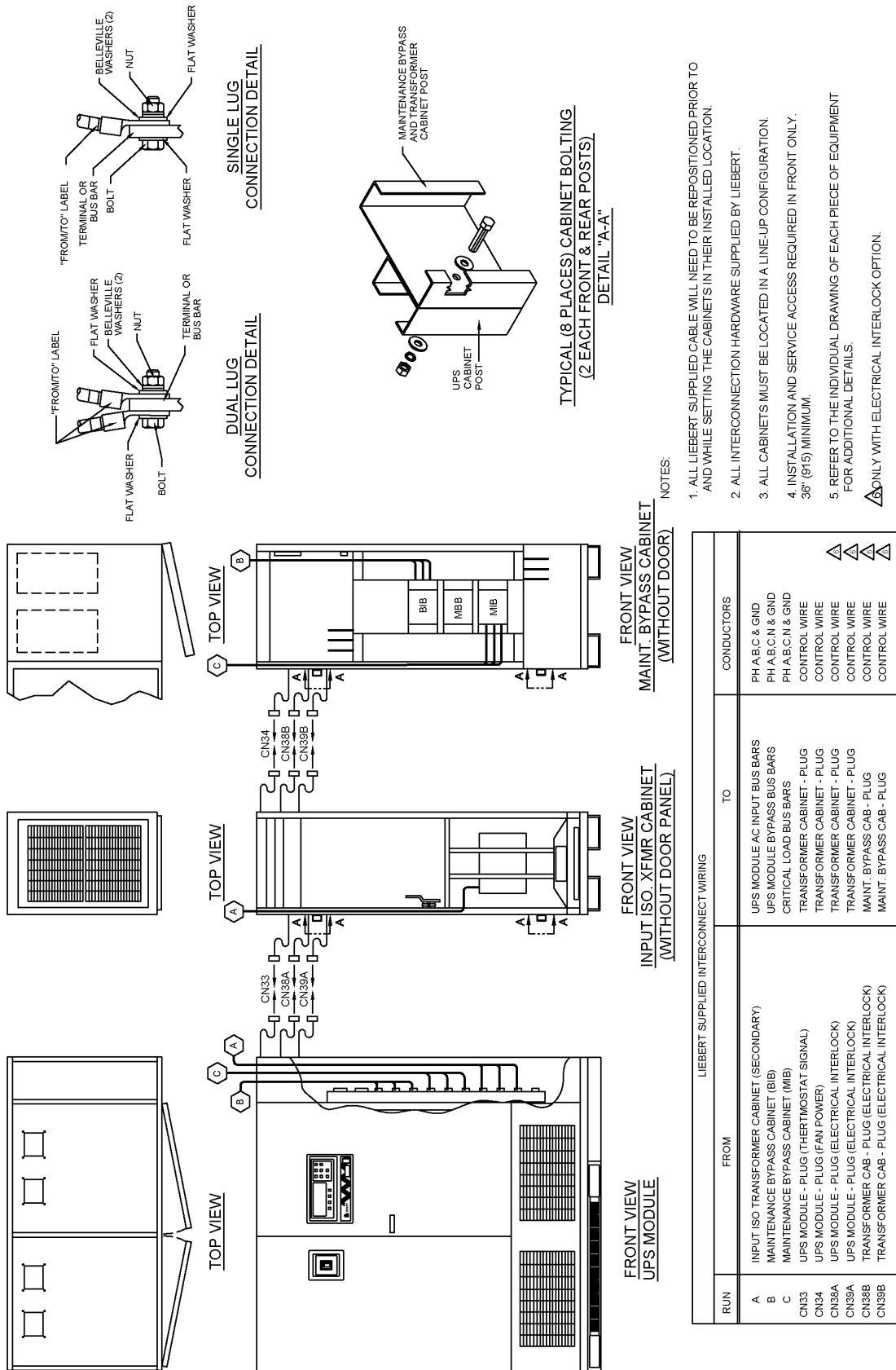
1. ALL LIEBERT SUPPLIED CABLE WILL NEED TO BE REPOSITIONED PRIOR TO AND WHILE SETTING THE CABINETS IN THEIR INSTALLED LOCATION.
2. ALL INTERCONNECTION HARDWARE SUPPLIED BY LIEBERT.
3. ALL CABINETS MUST BE LOCATED IN A LINE-UP CONFIGURATION.
4. INSTALLATION AND SERVICE ACCESS REQUIRED IN FRONT ONLY. 36" (915) MINIMUM.
5. REFER TO THE INDIVIDUAL DRAWING OF EACH PIECE OF EQUIPMENT FOR ADDITIONAL DETAILS.
6. ONLY WITH ELECTRICAL INTERLOCK OPTION.
7. ALL LIEBERT SUPPLIED WIRING TO BE RUN INTERNALLY.

88-797607-53  
Rev. 03



LIEBERT SUPPLIED INTERCONNECT WIRING		FROM	TO	CONDUCTORS
B	MAINTENANCE BYPASS CABINET (BIB)	BYPASS BUS BARS	PH A,B,C,N & GND	PH A,B,C,N & GND
C	MAINTENANCE BYPASS CABINET (MIB)	CRITICAL LOAD BUS BARS	PH A,B,C,N & GND	PH A,B,C,N & GND
CN38	MAINTENANCE BYPASS CABINET - PLUG	UPS MODULE - PLUG	CONTROL WIRE	CONTROL WIRE
CN39	MAINTENANCE BYPASS CABINET - PLUG	UPS MODULE - PLUG	CONTROL WIRE	CONTROL WIRE

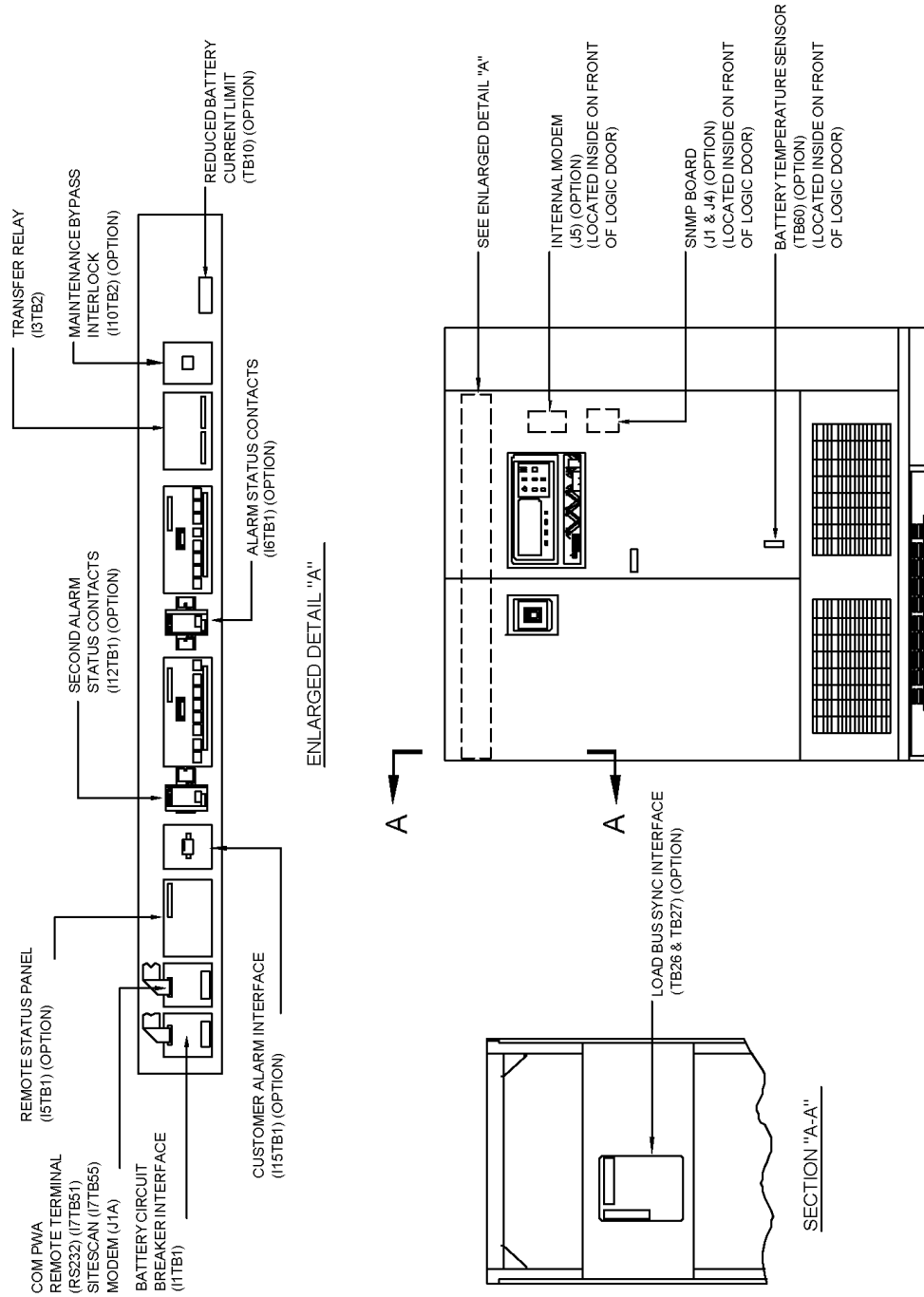
Figure 30 Line-up detail, 300-450kVA Single-Module System with input isolation transformer cabinet and 3-breaker Maintenance Bypass Cabinet



88-797607-56  
Rev. 03



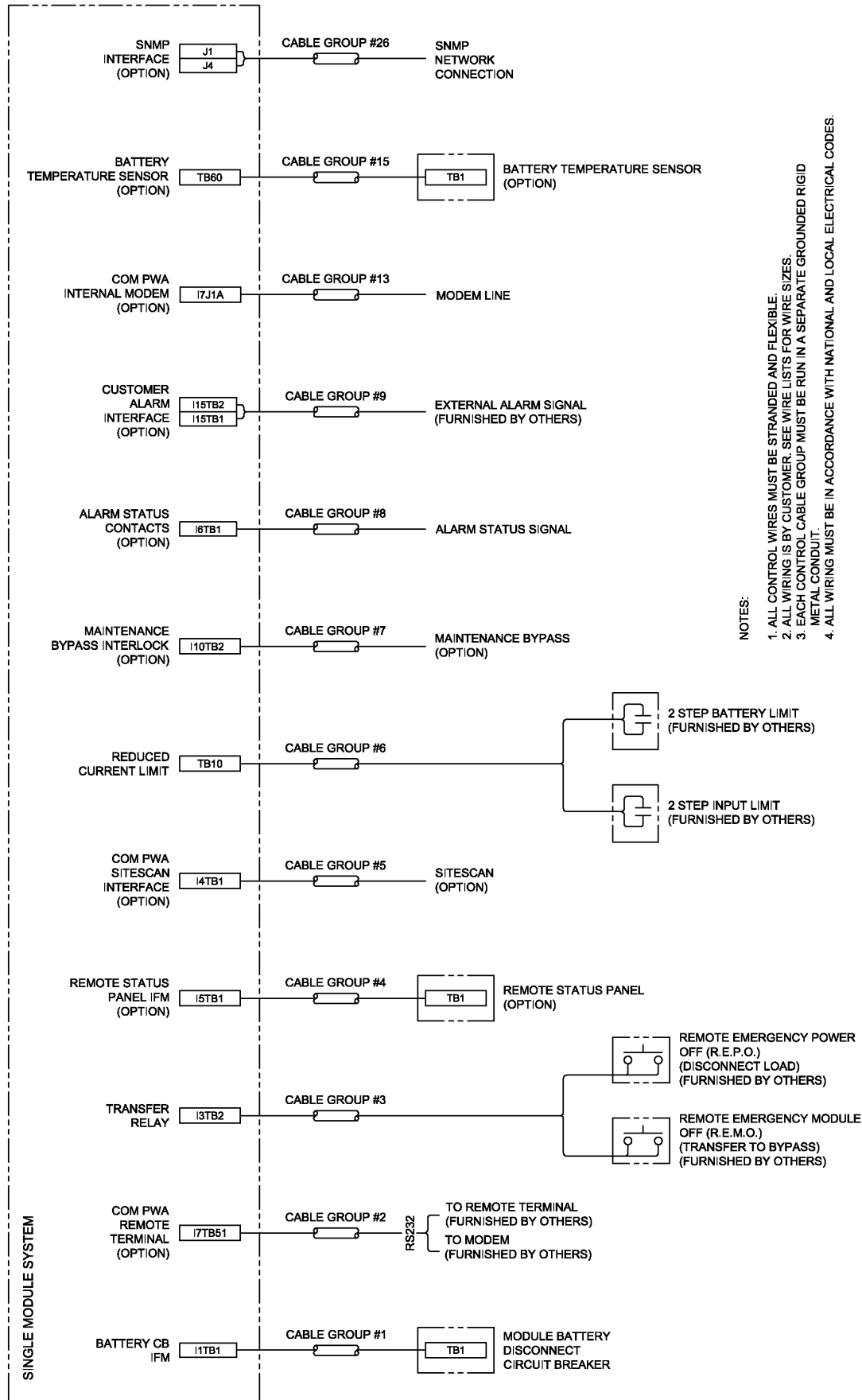
Figure 31 Control connection location diagram, Single-Module System, 300-500kVA



FOR UNITS MANUFACTURED BEFORE 12/31/02, SEE DRAWING 96-797601-59

96-797619-59A  
Rev. 03

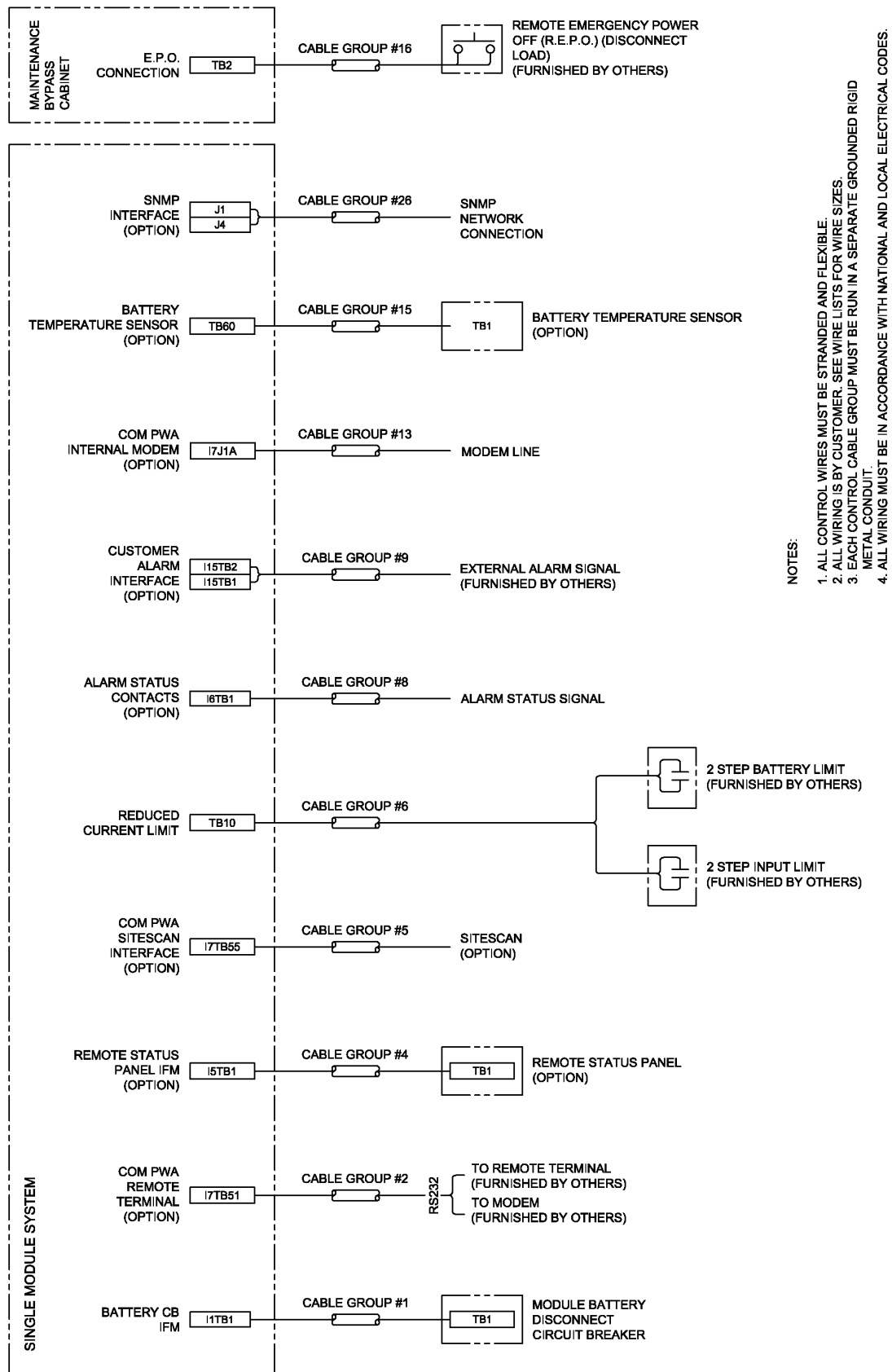
Figure 32 Control wiring, external interconnect diagram, Single-Module System, 300-750kVA



96-797619-47A  
Rev. 04

FOR UNITS MANUFACTURED BEFORE 12/31/02, SEE DRAWING 96-797619-47

Figure 33 Control wiring, external interconnect diagram, Single-Module System with Maintenance Bypass Cabinet, 300-750kVA



- NOTES:
1. ALL CONTROL WIRES MUST BE STRANDED AND FLEXIBLE.
  2. ALL WIRING IS BY CUSTOMER. SEE WIRE LISTS FOR WIRE SIZES.
  3. EACH CONTROL CABLE GROUP MUST BE RUN IN A SEPARATE GROUNDED RIGID METAL CONDUIT.
  4. ALL WIRING MUST BE IN ACCORDANCE WITH NATIONAL AND LOCAL ELECTRICAL CODES.

FOR UNITS MANUFACTURED BEFORE 12/31/02, SEE DRAWING 96-797619-49

96-797619-49A  
Rev. 07

Figure 34 Control wire list, external interconnections, standard wiring, Single-Module System, 300-750kVA

WIRE NO.	TERMINAL DESIGNATION		SIGNAL NAME	MAXIMUM VOLTAGE	MAXIMUM CURRENT	COLOR	WIRE SIZE & TYPE	MAX. LENGTH	REMARKS
	FROM	TO							
CABLE GROUP #1 (BATTERY CB IFM) FROM I1 IN UPS MODULE TO TB1 ON MODULE BATTERY DISCONNECT (MBD) CIRCUIT BREAKER									
901	I1TB1-1	TB1-1	TRIP SIGNAL (+)	+24VDC	100mA		1/C #14	500 FT. (150 METERS)	
902	I1TB1-2	TB1-2	TRIP SIGNAL (-)	-24VDC	100mA				
903	I1TB1-7	TB1-7	AUX "A" COMM	24VDC	100mA				
904	I1TB1-8	TB1-8	AUX "A" N.O.	24VDC	100mA				
CABLE GROUP #3 (TRANSFER RELAY) FROM I3 IN UPS MODULE TO R.E.M.O. & R.E.P.O.									
711	I3TB2-1	N.O.	REMOTE EMER. MOD. OFF	24VDC	1A		1/C #14	500 FT. (150 METERS)	
712	I3TB2-2	COMM.	REMOTE EMER. MOD. OFF	24VDC	1A				
713	I3TB2-3	N.O.	REMOTE EMER. POWER OFF	24VDC	1A				
714	I3TB2-4	COMM.	REMOTE EMER. POWER OFF	24VDC	1A				
CABLE GROUP #6 (REDUCED CURRENT LIMIT) FROM TB10 IN UPS MODULE TO CUSTOMER CONNECTION (F.B.O.)									
761	TB10-4	N.O.	2 STEP BATTERY LIMIT	24VDC	100mA		1/C #14	500 FT. (150 METERS)	
762	TB10-5	COMM.	2 STEP BATTERY LIMIT	24VDC	100mA				
763	TB10-7	N.O.	2 STEP INPUT LIMIT	24VDC	100mA				
764	TB10-8	COMM.	2 STEP INPUT LIMIT	24VDC	100mA				

NOTES:

1. EACH CABLE GROUP MUST BE RUN IN A SEPARATE STEEL RACEWAY TO PREVENT CONTROL SIGNAL INTERFERENCE.
2. REFER TO UPS MODULE CONTROL CONNECTION LOCATION DIAGRAM FOR LOCATION OF WIRING CONNECTIONS.
3. FOR OPTION WIRING CONNECTIONS, REFER TO INDIVIDUAL CONTROL WIRE LISTS.
4. F.B.O. - FURNISHED BY OTHERS.
5. ALL EXTERNAL WIRE FURNISHED BY OTHERS.
6. N.O. = NORMALLY OPEN, COMM. = COMMON.
7. ALL WIRING MUST BE IN ACCORDANCE WITH NATIONAL AND LOCAL ELECTRICAL CODES.

96-797619-48  
Rev. 05

Figure 35 Control wire list, external interconnections, standard wiring, Single-Module System with Maintenance Bypass Cabinet, 300-750kVA

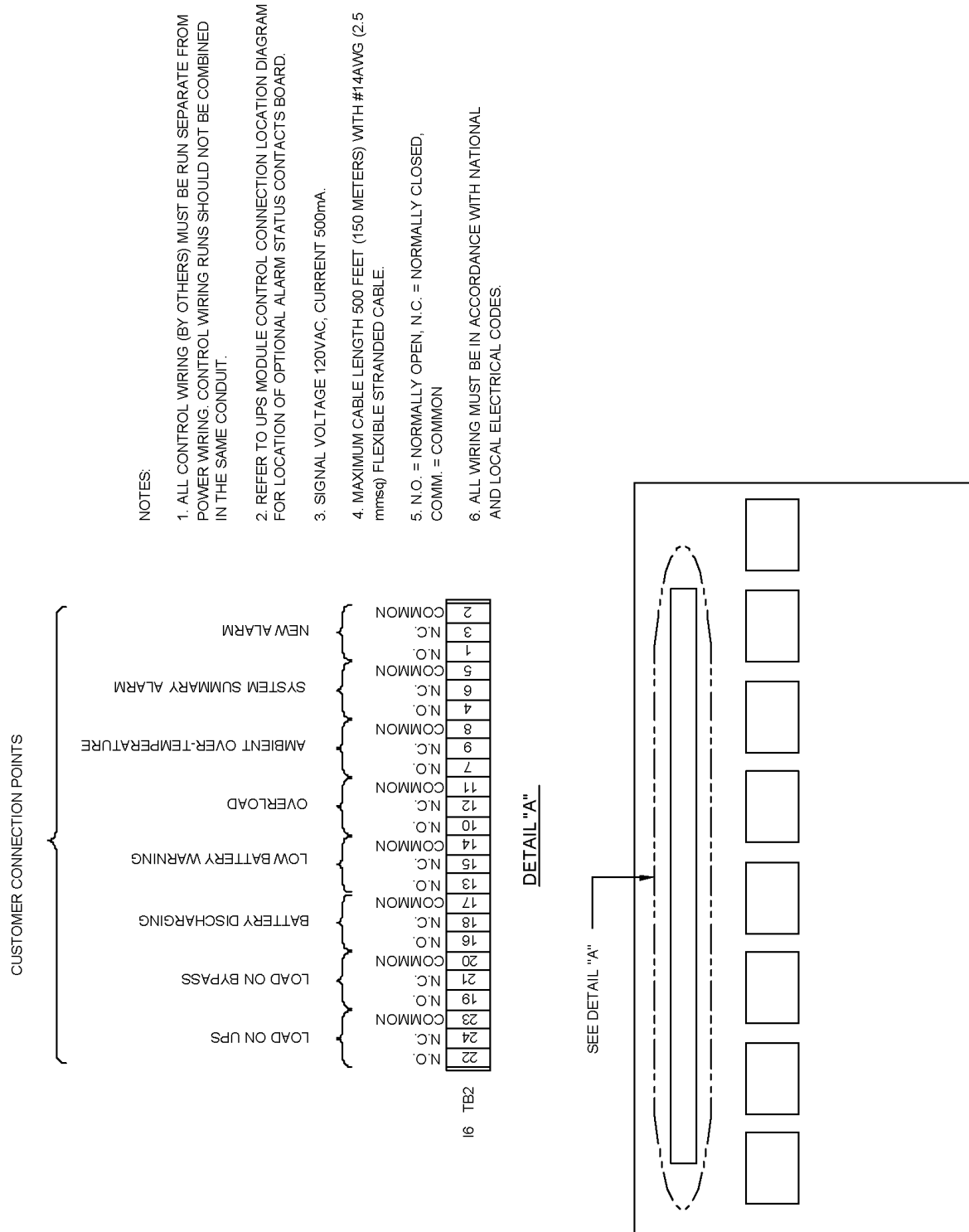
WIRE NO.	TERMINAL DESIGNATION		SIGNAL NAME	MAXIMUM VOLTAGE	MAXIMUM CURRENT	COLOR	WIRE SIZE & TYPE	MAX. LENGTH	REMARKS
	FROM	TO							
CABLE GROUP #1 (BATTERY CB IFM) FROM I1 IN UPS MODULE TO TB1 ON MODULE BATTERY DISCONNECT (MBD) CIRCUIT BREAKER									
901	I1TB1-1	TB1-1	TRIP SIGNAL (+)	+24VDC	100mA		1/C#14	500 FT. (150 METERS)	
902	I1TB1-2	TB1-2	TRIP SIGNAL (-)	-24VDC	100mA				
903	I1TB1-7	TB1-7	AUX "A" COMM	24VDC	100mA				
904	I1TB1-8	TB1-8	AUX "A" N.O.	24VDC	100mA				
CABLE GROUP #6 (REDUCED CURRENT LIMIT) FROM I2 IN UPS MODULE TO CUSTOMER CONNECTION (F.B.O.)									
761	TB10-4	N.O.	2 STEP BATTERY LIMIT	24VDC	100mA		1/C#14	500 FT. (150 METERS)	
762	TB10-5	COMM.	2 STEP BATTERY LIMIT	24VDC	100mA				
763	TB10-7	N.O.	2 STEP INPUT LIMIT	24VDC	100mA				
764	TB10-8	COMM.	2 STEP INPUT LIMIT	24VDC	100mA				

NOTES:

1. EACH CABLE GROUP MUST BE RUN IN A SEPARATE STEEL RACEWAY TO PREVENT CONTROL SIGNAL INTERFERENCE.
2. REFER TO UPS MODULE CONTROL CONNECTION LOCATION DIAGRAM FOR LOCATION OF WIRING CONNECTIONS.
3. FOR OPTION WIRING CONNECTIONS, REFER TO INDIVIDUAL CONTROL WIRE LISTS.
4. F.B.O. - FURNISHED BY OTHERS.
5. ALL EXTERNAL WIRE FURNISHED BY OTHERS.
6. N.O. = NORMALLY OPEN, COMM. = COMMON.
7. ALL WIRING MUST BE IN ACCORDANCE WITH NATIONAL AND LOCAL ELECTRICAL CODES.

96-797619-50  
Rev. 05

Figure 36 Module control wiring, alarm status contacts option



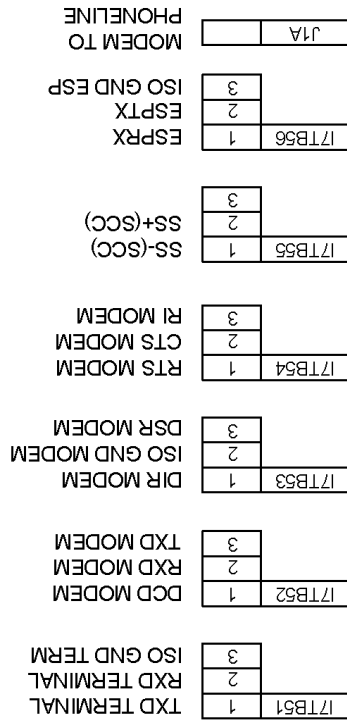
NOTES:

1. ALL CONTROL WIRING (BY OTHERS) MUST BE RUN SEPARATE FROM POWER WIRING. CONTROL WIRING RUNS SHOULD NOT BE COMBINED IN THE SAME CONDUIT.
2. REFER TO UPS MODULE CONTROL CONNECTION LOCATION DIAGRAM FOR LOCATION OF OPTIONAL ALARM STATUS CONTACTS BOARD.
3. SIGNAL VOLTAGE 120VAC, CURRENT 500mA.
4. MAXIMUM CABLE LENGTH 500 FEET (150 METERS) WITH #14AWG (2.5 mmsq) FLEXIBLE STRANDED CABLE.
5. N.O. = NORMALLY OPEN, N.C. = NORMALLY CLOSED, COMM. = COMMON
6. ALL WIRING MUST BE IN ACCORDANCE WITH NATIONAL AND LOCAL ELECTRICAL CODES.

98-797608-04  
Rev. 05

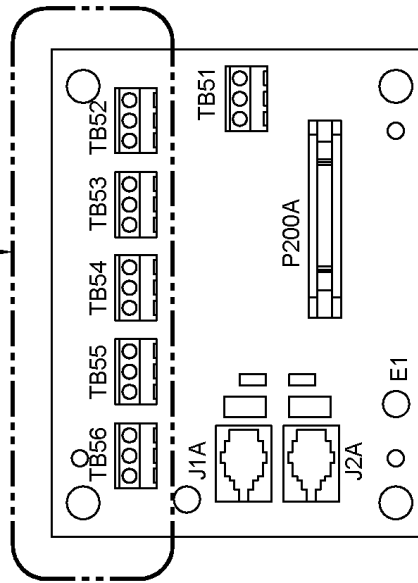
Figure 37 COM PWA, remote terminal (RS232) option, SiteScan option, internal modem option

CUSTOMER SUPPLIED INTERCONNECTING CABLE TO COM PWA



DETAIL "A"

SEE DETAIL "A"

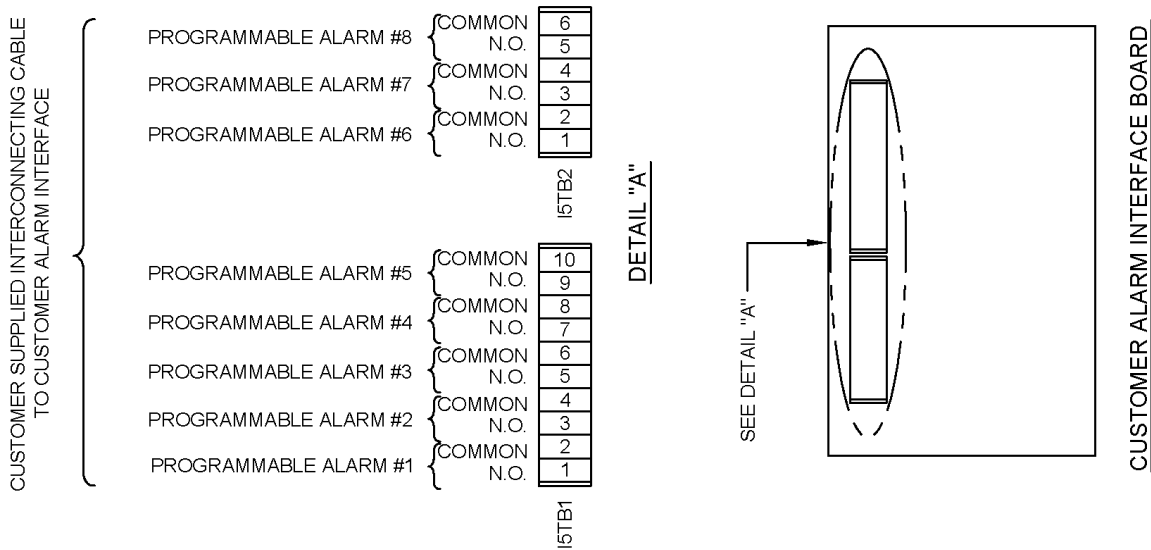


- NOTES:
1. ALL CONTROL WIRING (BY OTHERS) MUST BE RUN SEPARATE FROM POWER WIRING. CONTROL WIRING RUNS SHOULD NOT BE COMBINED IN THE SAME GROUNDED RIGID METAL CONDUIT.
  2. REFER TO UPS MODULE CONTROL CONNECTION LOCATION DIAGRAM FOR LOCATION OF OPTIONAL REMOTE TERMINAL INTERFACE BOARD.
  3. SIGNAL VOLTAGE 24VDC, CURRENT 100mA
  4. MAXIMUM CABLE LENGTH 100 FEET (30 METERS) WITH #22AWG (0.50 mm sq) TWISTED SHIELDED CABLE.
  5. ALL WIRING MUST BE IN ACCORDANCE WITH NATIONAL AND LOCAL ELECTRICAL CODES.
  6. CONNECT TO J1A WITH STANDARD RJ11 MODULAR CONNECTOR. LENGTH LIMITATIONS ACCORDING TO TELEPHONE COMPANY SPECIFICATIONS.

FOR UNITS MANUFACTURED BEFORE 12/31/02, SEE DRAWING 98-797608-07

98-797608-07A  
Rev. 02

Figure 38 Control wiring, customer alarm interface option



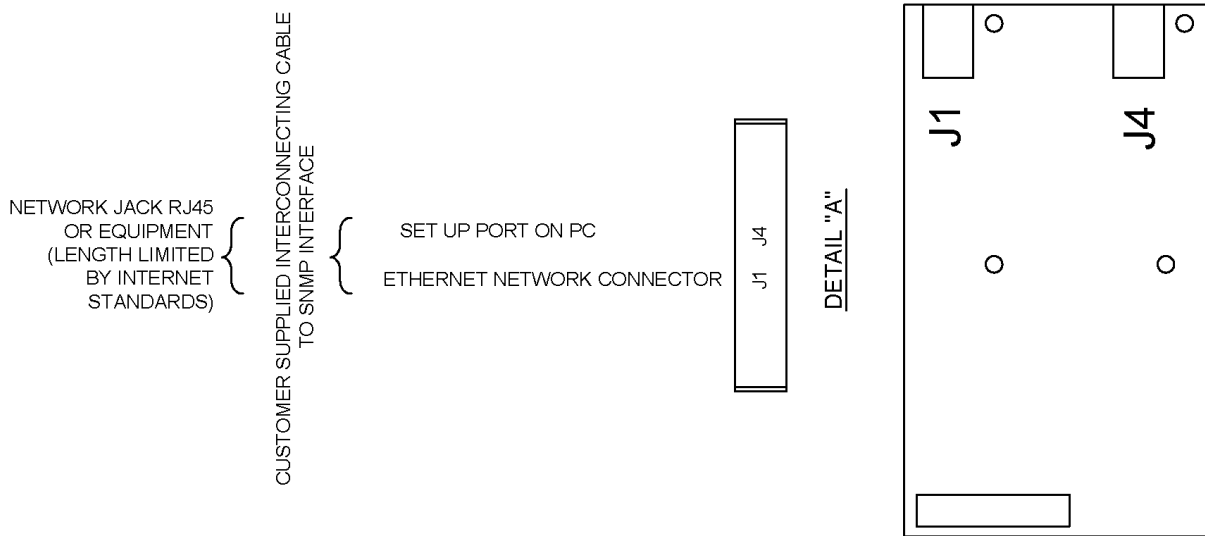
NOTES:

1. ALL CONTROL WIRING (BY OTHERS) MUST BE RUN SEPARATE FROM POWER WIRING. CONTROL WIRING RUNS SHOULD NOT BE COMBINED IN THE SAME CONDUIT.
2. REFER TO UPS MODULE CONTROL CONNECTION LOCATION DIAGRAM FOR LOCATION OF OPTIONAL CUSTOMER ALARM INTERFACE BOARD.
3. SIGNAL VOLTAGE 24VDC, CURRENT 100mA.
4. MAXIMUM CABLE LENGTH 500 FEET (150 METERS) WITH #14AWG (2.5 mmsq) FLEXIBLE STRANDED CABLE.
5. N.O. = NORMALLY OPEN, N.C. = NORMALLY CLOSED, COMM. = COMMON
6. ALL WIRING MUST BE IN ACCORDANCE WITH NATIONAL AND LOCAL ELECTRICAL CODES.

98-797608-09  
Rev. 03



Figure 39 Control wiring, SNMP interface option



NOTES:

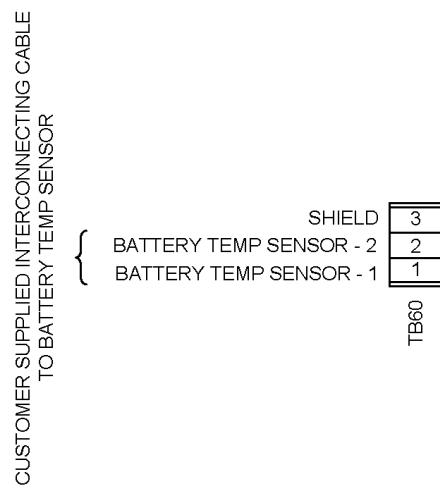
1. ALL CONTROL WIRING (BY OTHERS) MUST BE RUN SEPARATE FROM POWER WIRING. CONTROL WIRING RUNS SHOULD NOT BE COMBINED IN THE SAME GROUNDED RIGID METAL CONDUIT.
2. REFER TO UPS MODULE CONTROL CONNECTION LOCATION DIAGRAM FOR LOCATION OF OPTIONAL SNMP BOARD.
3. WIRE SIZE & TYPE: TELEPHONE CABLE. LENGTH LIMITED BY INTERNET STANDARDS.
4. ALL WIRING MUST BE IN ACCORDANCE WITH NATIONAL AND LOCAL ELECTRICAL CODES.

98-797608-11A  
Rev. 02

FOR UNITS MANUFACTURED BEFORE 12/31/02, SEE DRAWING 98-797608-11



Figure 41 Control wiring, battery temperature sensor interface



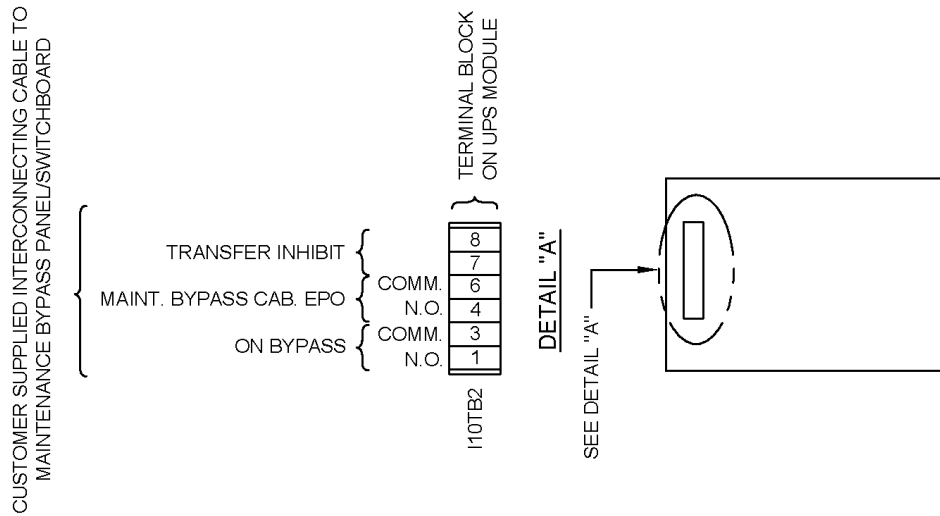
BATTERY TEMPERATURE SENSOR

NOTES:

1. REFER TO UPS MODULE CONTROL CONNECTION LOCATION DIAGRAM FOR LOCATION OF OPTIONAL BATTERY TEMPERATURE SENSOR TERMINAL BLOCK.
2. SIGNAL VOLTAGE 24VDC, CURRENT 100mA.
3. MAXIMUM CABLE LENGTH 100 FEET (30 METERS) WITH #18AWG (1.0 mmsq) TWISTED PAIR SHIELDED CABLE.
4. ALL WIRING MUST BE IN ACCORDANCE WITH NATIONAL AND LOCAL ELECTRICAL CODES.

98-797608-10  
Rev. 04

Figure 42 Control wiring, maintenance bypass interlock option



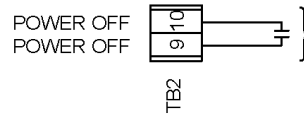
MAINTENANCE BYPASS INTERLOCK BOARD

NOTES:

1. ALL CONTROL WIRING (BY OTHERS) MUST BE RUN SEPARATE FROM POWER WIRING. CONTROL WIRING RUNS SHOULD NOT BE COMBINED IN THE SAME CONDUIT.
2. REFER TO UPS MODULE CONNECTION LOCATION DIAGRAM FOR LOCATION OF OPTIONAL MAINTENANCE BYPASS INTERLOCK BOARD.
3. SIGNAL VOLTAGE 120VAC, CURRENT 5A
4. MAXIMUM CABLE LENGTH 500 FEET (150 METERS) WITH #14AWG (2.5 mm<sup>2</sup>sq) FLEXIBLE STRANDED CABLE.
5. N.O. = NORMALLY OPEN, COMM. = COMMON
6. ALL WIRING MUST BE IN ACCORDANCE WITH NATIONAL AND LOCAL ELECTRICAL CODES.

**98-797608-05**  
**Rev. 04**

Figure 43 Control wiring, Maintenance Bypass Cabinet option



CUSTOMER SUPPLIED INTERCONNECTING CABLE TO  
EPO/EMO PUSH BUTTON STATIONS

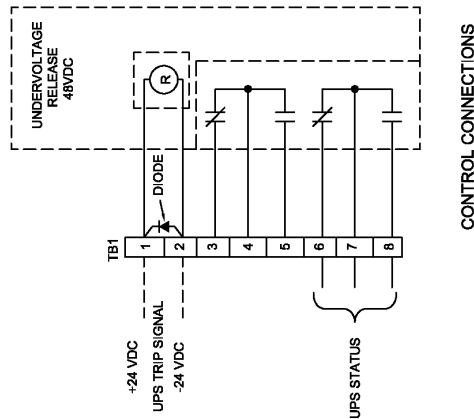
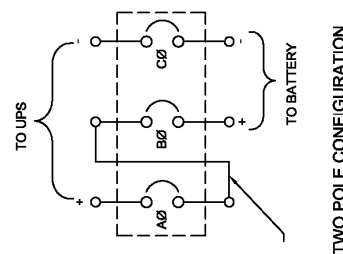
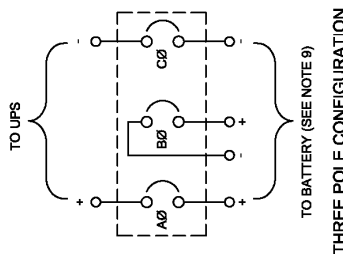
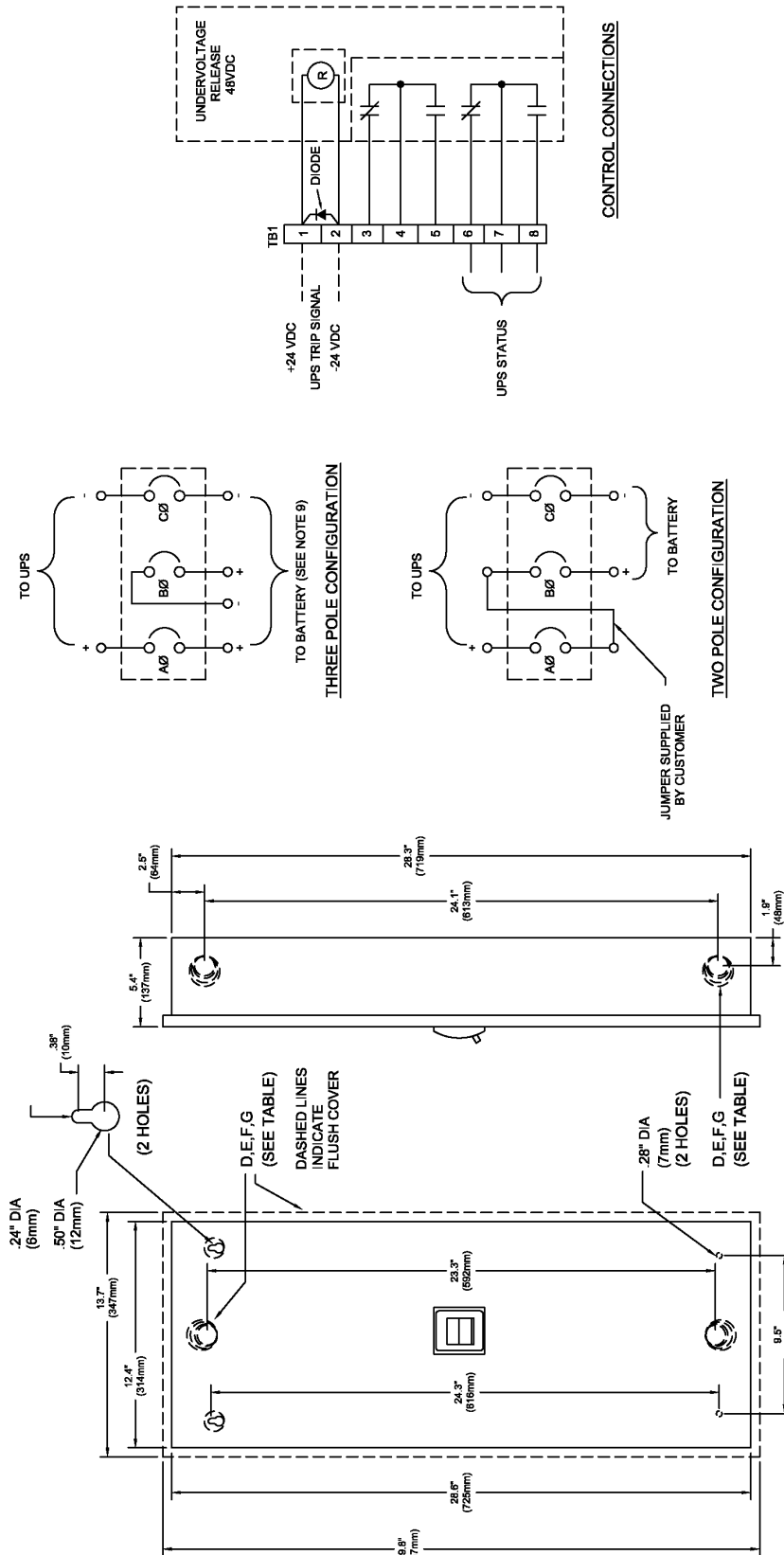
REMOTE EMERGENCY POWER OFF

NOTES:

1. ALL CONTROL WIRING (BY OTHERS) MUST BE RUN SEPARATE FROM POWER WIRING. CONTROL WIRING RUNS SHOULD NOT BE COMBINED IN THE SAME CONDUIT.
2. REFER TO MAINTENANCE BYPASS CABINET OUTLINE DRAWING FOR LOCATION OF WIRING CONNECTIONS.
3. SIGNAL VOLTAGE 120VAC, CURRENT 5A.
4. MAXIMUM CABLE LENGTH 500 FEET (150 METERS) WITH #14AWG (2.5 mm<sup>2</sup>) FLEXIBLE STRANDED CABLE.
5. ALL WIRING MUST BE IN ACCORDANCE WITH NATIONAL AND LOCAL ELECTRICAL CODES.

98-797608-14  
Rev. 03

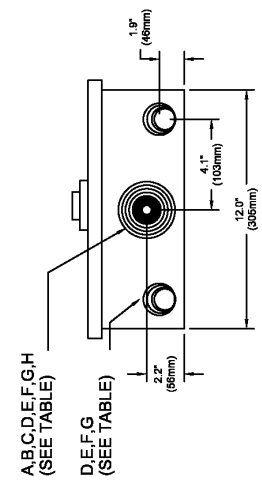
Figure 44 Outline drawing, single-breaker module battery disconnect, 175-250A, 600VDC circuit breaker



**NOTES:**

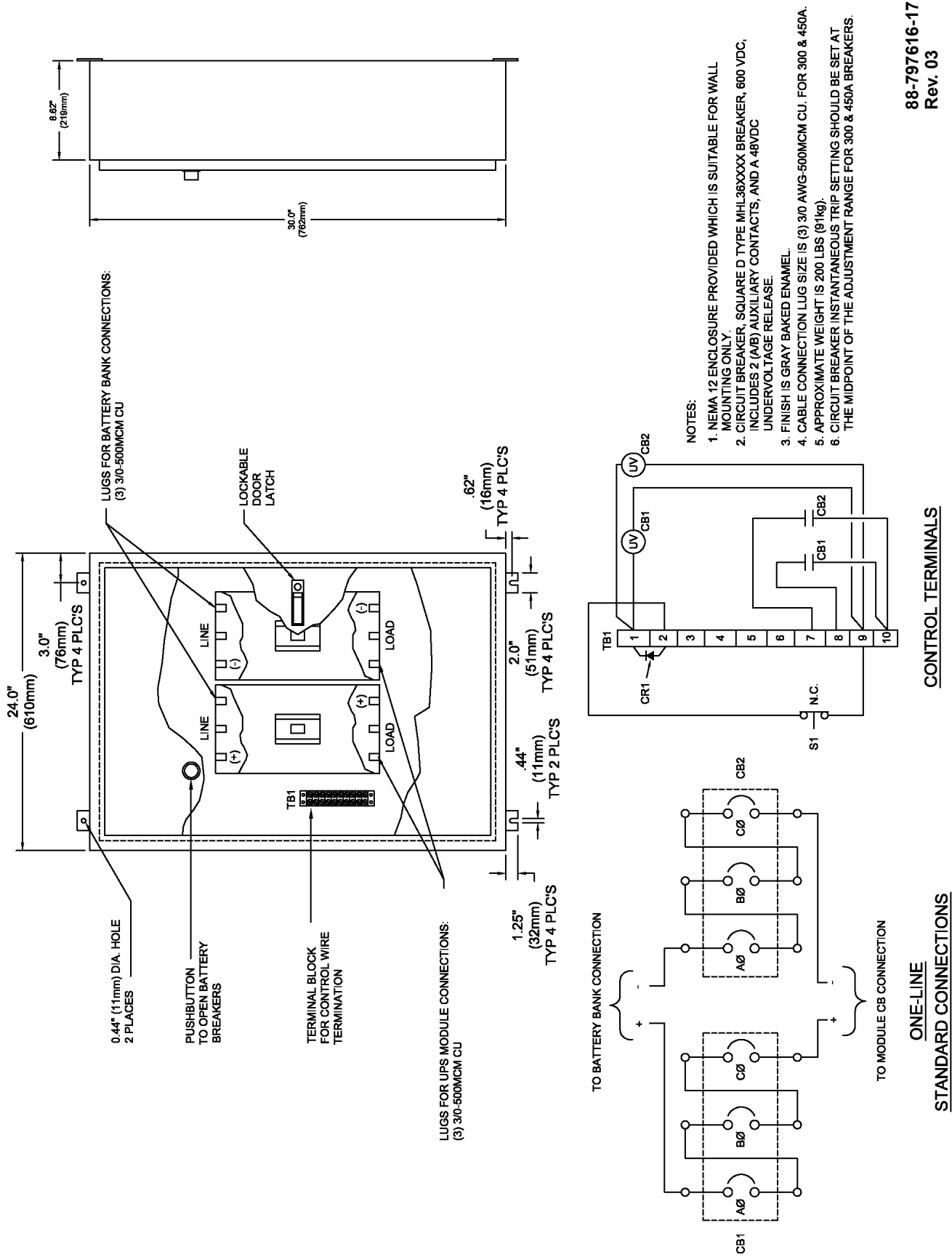
- NEMA 1 ENCLOSURE PROVIDED WHICH IS SUITABLE FOR WALL MOUNTING ONLY.
- CIRCUIT BREAKER IS SQUARE D TYPE KHL38XXX. BREAKER INCLUDES 2(A/B) AUXILIARY CONTACTS, AND A 48VDC UNDERVOLTAGE RELEASE.
- KNOCKOUTS PROVIDED FOR FIELD WIRING CONNECTIONS.
- FINISH IS GRAY BAKED ENAMEL.
- FOR APPLICATIONS WHERE A TWO POLE CONFIGURATION IS REQUIRED THE CUSTOMER MUST ADD A CABLE JUMPER OF EQUAL AMPACITY TO THE BATTERY CIRCUIT CONDUCTORS AS SHOWN ON THIS DRAWING.
- CENTER POLE USED TO BREAK MIDPOINT OF BATTERY STRING.
- CABLE CONNECTION LUG SIZE IS (1) 6 AWG-350KCMIL CU (16-185mm<sup>2</sup>).
- APPROXIMATE WEIGHT IS 150 LBS (68 kg).
- CIRCUIT BREAKER INSTANTANEOUS TRIP SETTING SHOULD BE SET AT THE MINIMUM OF THE ADJUSTMENT RANGE.
- GROUND LUGS ARE PROVIDED FOR (2) #10-20 AWG CU (6-70mm<sup>2</sup>) CONDUCTORS.

SYMBOL	CONDUIT SIZE		DIAMETER	
	IN	mm	IN	mm
A	.50	13	.88	22
B	.75	19	1.13	29
C	1.00	25	1.38	35
D	1.25	32	1.75	45
E	1.50	38	2.00	51
F	2.00	51	2.50	64
G	2.50	64	3.00	76
H	3.00	76	3.63	92



88-797606-17  
Rev. 05

Figure 45 Outline drawing, dual-breaker module battery disconnect, 175-250A, 600VDC circuit breaker



LUGS FOR BATTERY BANK CONNECTIONS:  
(3) 3/0-500MCM CU

0.44" (11mm) DIA. HOLE  
2 PLACES

PUSHBUTTON  
TO OPEN BATTERY  
BREAKERS

TERMINAL BLOCK  
FOR CONTROL WIRE  
TERMINATION

LUGS FOR UPS MODULE CONNECTIONS:  
(3) 3/0-500MCM CU

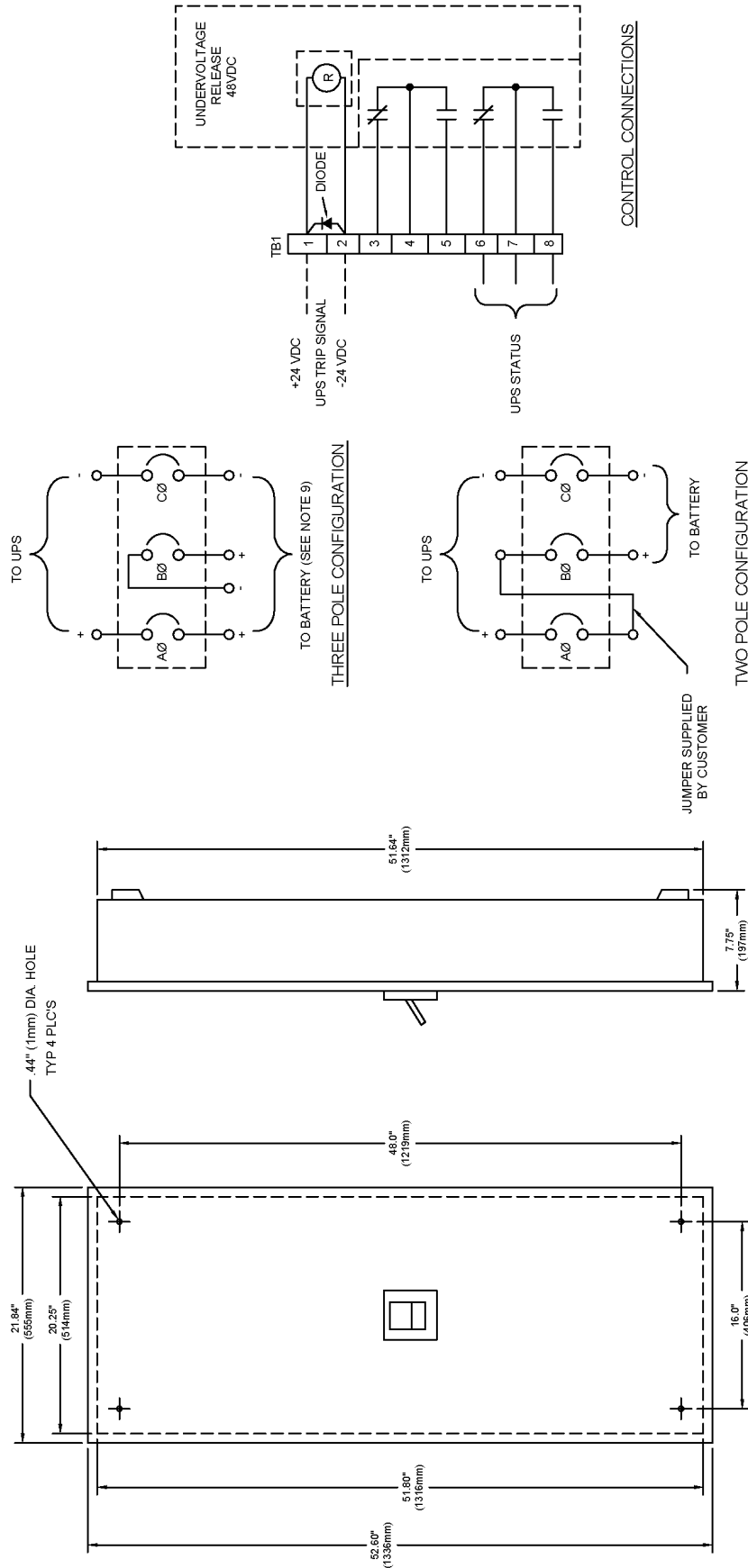
- NOTES:
1. NEMA 12 ENCLOSURE PROVIDED WHICH IS SUITABLE FOR WALL MOUNTING ONLY.
  2. CIRCUIT BREAKER, SQUARE D TYPE MHL36XXXX BREAKER, 600 VDC, INCLUDES 2 (A/B) AUXILIARY CONTACTS, AND A 48VDC UNDERVOLTAGE RELEASE.
  3. FINISH IS GRAY BAKED ENAMEL.
  4. CABLE CONNECTION LUG SIZE IS (3) 3/0 AWG-500MCM CU. FOR 300 & 450A.
  5. APPROXIMATE WEIGHT IS 200 LBS (91kg).
  6. CIRCUIT BREAKER INSTANTANEOUS TRIP SETTING SHOULD BE SET AT THE MIDDLE OF THE ADJUSTMENT RANGE FOR 300 & 450A BREAKERS.

88-797616-17  
Rev. 03

CONTROL TERMINALS

ONE-LINE  
STANDARD CONNECTIONS

Figure 46 Outline drawing, single-breaker module battery disconnect, 300, 450, 600, 800, 1000, 1200A



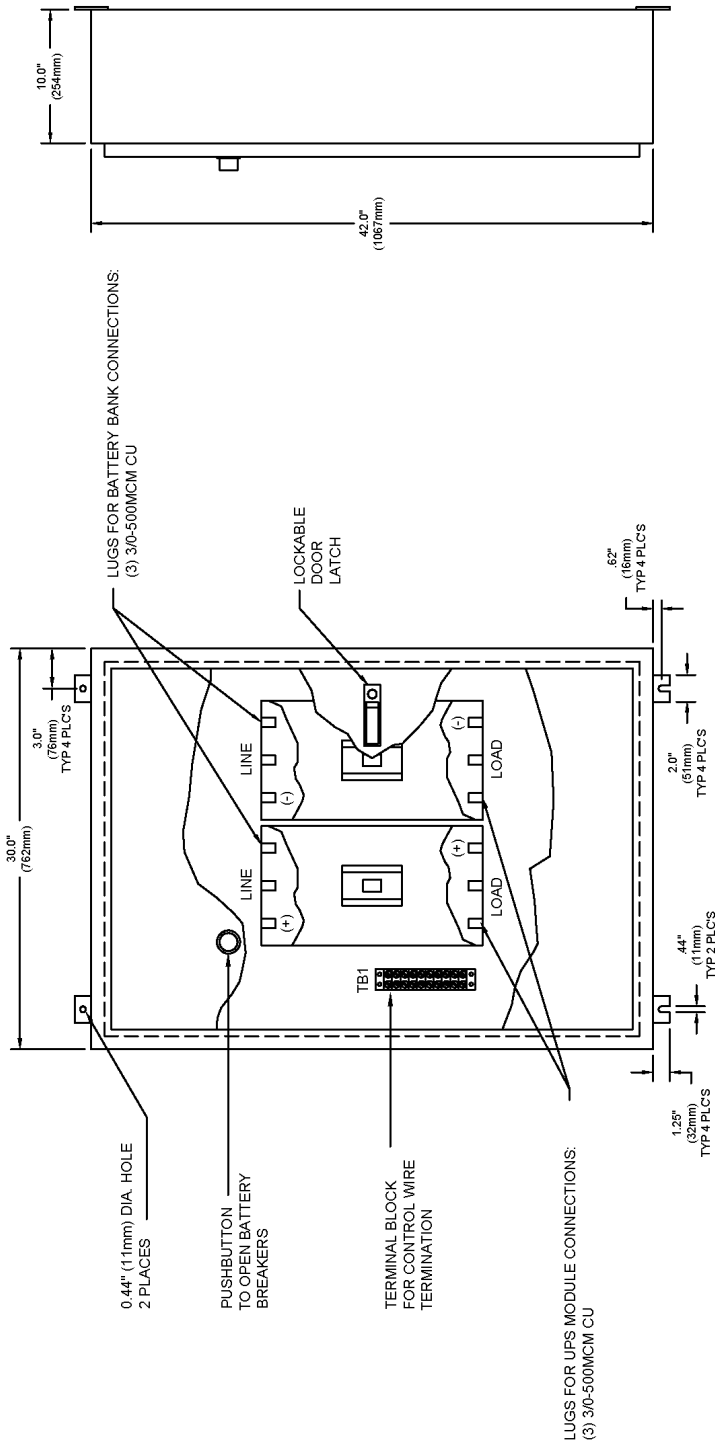
NOTES:

1. NEMA 1 ENCLOSURE PROVIDED WHICH IS SUITABLE FOR WALL MOUNTING ONLY.
2. CIRCUIT BREAKER, SQUARE D TYPE MHL36XXX BREAKER, 600 VDC, INCLUDES 2 (A/B) AUXILIARY CONTACTS, AND A 48VDC UNDERVOLTAGE RELEASE.
3. KNOCKOUTS PROVIDED FOR FIELD WIRING CONNECTIONS.
4. FINISH IS GRAY BAKED ENAMEL.
5. FOR APPLICATIONS WHERE A TWO POLE CONFIGURATION IS REQUIRED THE CUSTOMER MUST ADD A CABLE JUMPER OF EQUAL AMPACITY TO THE BATTERY CIRCUIT CONDUCTORS AS SHOWN ON THIS DRAWING.
6. CABLE CONNECTION LUG SIZE IS (3) 3/0 AWG-500MCM CU. FOR 300A - 1000A (4) 3/0 AWG-350MCM CU FOR 1200A
7. APPROXIMATE WEIGHT IS 150 LBS (68kg).
8. CIRCUIT BREAKER INSTANTANEOUS TRIP SETTING SHOULD BE SET AT THE MIDPOINT OF THE ADJUSTMENT RANGE. FOR 600A - 1200A BREAKERS AND AT THE MINIMUM OF THE ADJUSTMENT RANGE FOR 300 & 450A BREAKERS.
9. CENTER POLE USED TO BREAK MIDPOINT OF BATTERY STRING.
10. GROUND LUGS ARE PROVIDED FOR (4) #6-250MCM CONDUCTORS.

88-797616-09  
Rev. 08

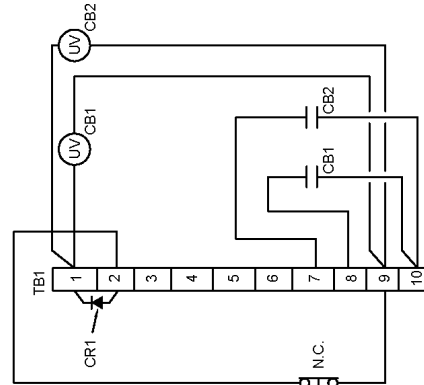


Figure 47 Outline drawing, dual-breaker module battery disconnect, 300 & 450A

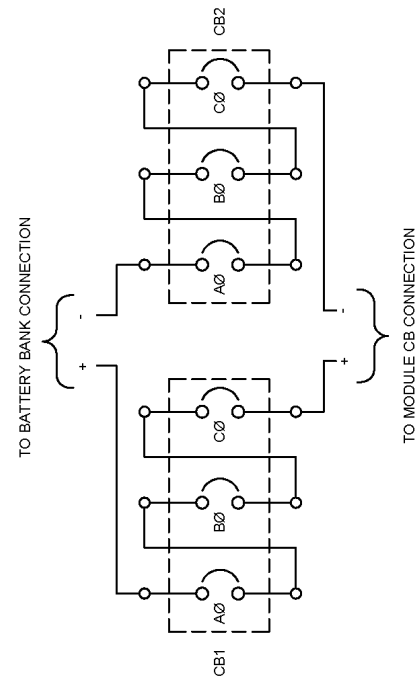


NOTES:

1. NEMA 12 ENCLOSURE PROVIDED WHICH IS SUITABLE FOR WALL MOUNTING ONLY.
2. CIRCUIT BREAKER, SQUARE D TYPE MHL36XXXX BREAKER, 600 VDC, INCLUDES 2 (A/B) AUXILIARY CONTACTS, AND A 48VDC UNDERVOLTAGE RELEASE.
3. FINISH IS GRAY BAKED ENAMEL.
4. CABLE CONNECTION LUG SIZE IS (3) 3/0 AWG-500MCM CU. FOR 300 & 450A.
5. APPROXIMATE WEIGHT IS 200 LBS (91kg).
6. CIRCUIT BREAKER INSTANTANEOUS TRIP SETTING SHOULD BE SET AT THE MIDPOINT OF THE ADJUSTMENT RANGE FOR 300 & 450A BREAKERS.



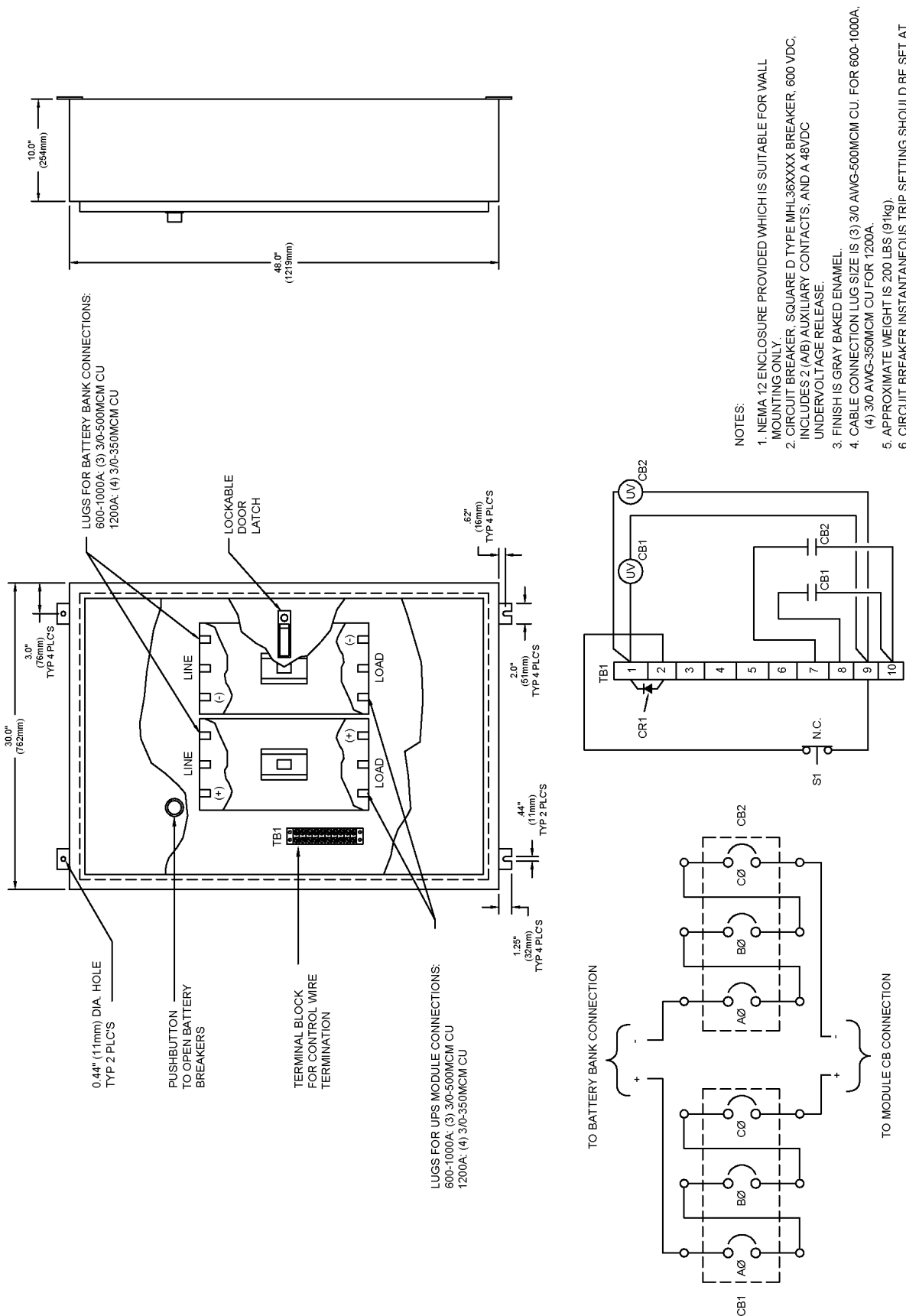
CONTROL TERMINALS



ONE-LINE  
STANDARD CONNECTIONS

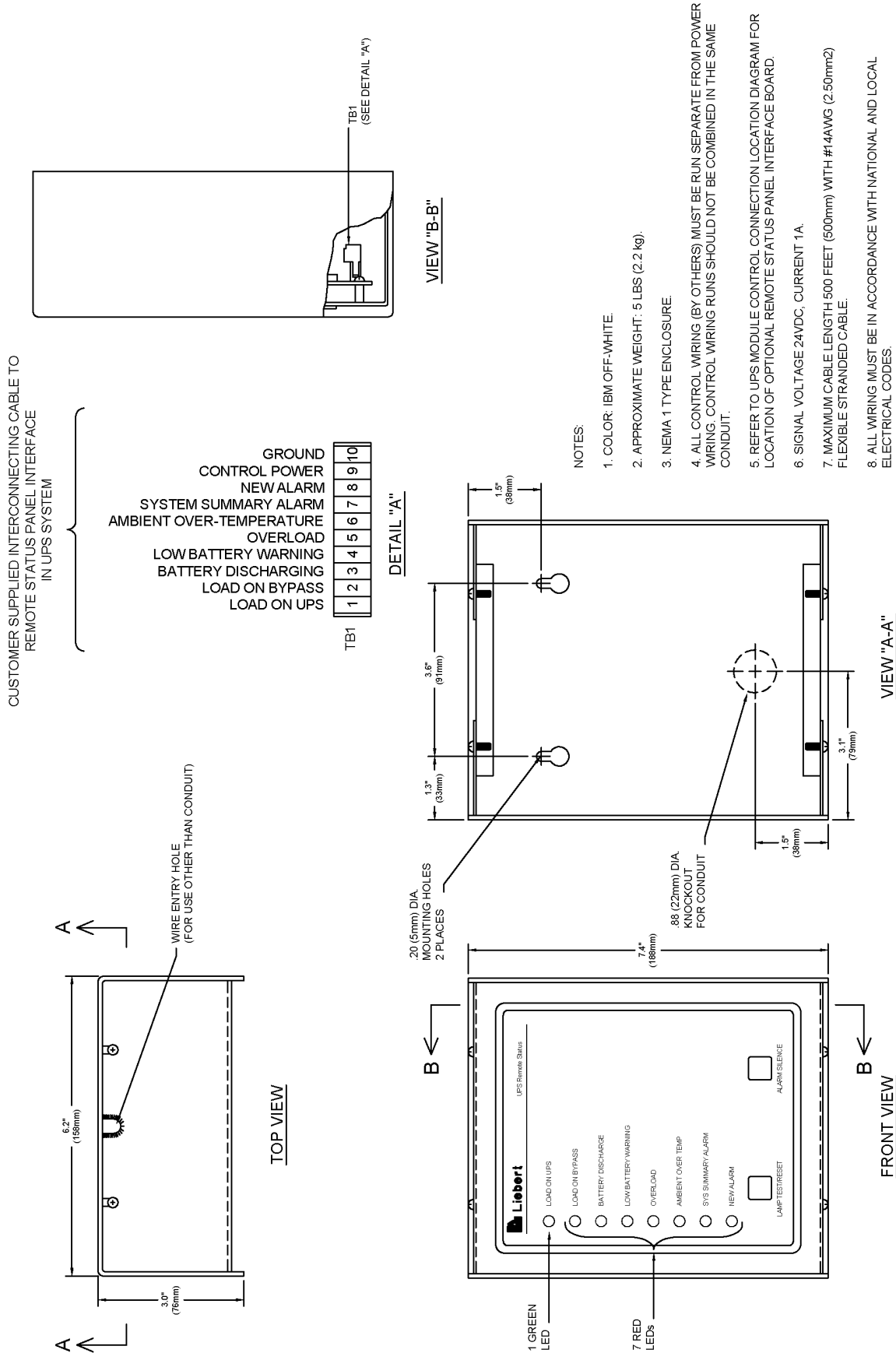
88-797616-08  
Rev. 05

Figure 48 Outline drawing, dual-breaker module battery disconnect, 600, 800, 1000, 1200A



88-797616-07  
 Rev. 08

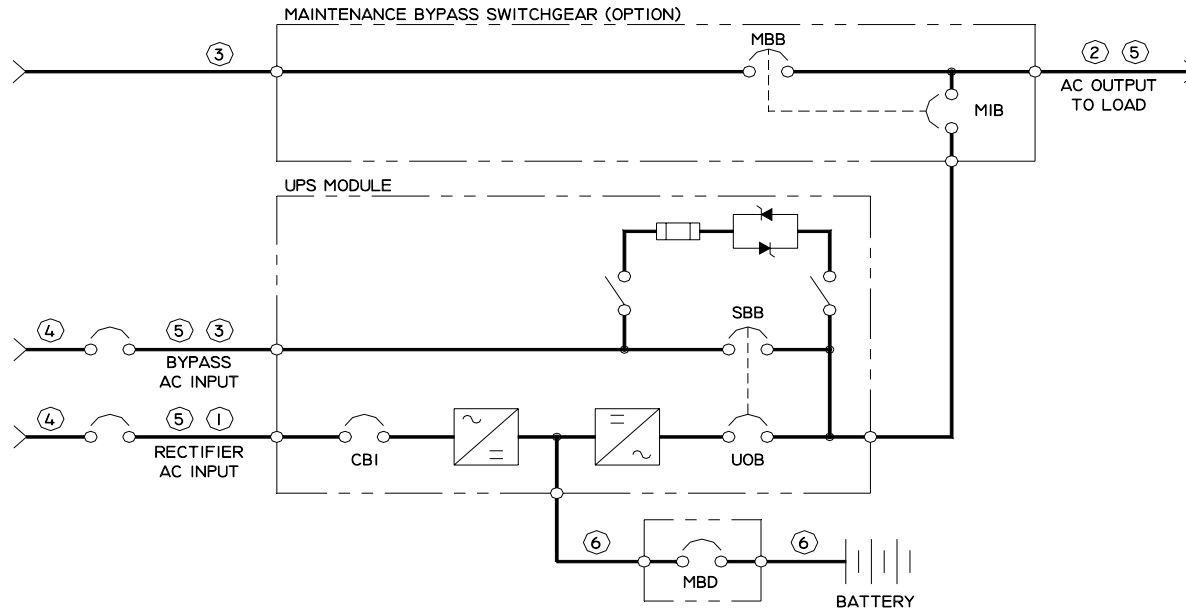
Figure 49 Outline drawing, remote status panel, surface mount



88-791617-01  
Rev. 05



## APPENDIX A - SITE PLANNING DATA, SERIES 610, 300-450KVA, SINGLE-MODULE SYSTEMS



### Notes for Tables 6 - 8

- Nominal rectifier AC input current (considered continuous) is based on full rated output load. Maximum current includes nominal input current and maximum battery recharge current (considered noncontinuous). Continuous and noncontinuous current limits are defined in NEC 100. Maximum input current is controlled by current limit setting which is adjustable. Values shown for maximum setting are 125% of nominal input current. Standard factory setting is 115%.
- Nominal AC output current (considered continuous) is based on full rated output load. Maximum current includes nominal output current and overload current for 10 minutes.
- Bypass AC input current (considered continuous) is based on full rated output load.
- Feeder protection (by others in external equipment) for rectifier AC input and bypass AC input is recommended to be provided by separate overcurrent protection devices.
- UPS output load cables must be run in separate conduit from input cables.
- Power cable from module DC bus to battery should be sized for a total maximum 2.0 volt line drop (power cable drop plus return cable drop as measured at the module) at maximum discharge current.
- Grounding conductors to be sized per NEC 250-95. Neutral conductors to be sized for full capacity—per NEC 310-16, Note 10—for systems with 4-wire loads and half capacity for systems with 3-wire loads.
- Rectifier AC Input: 3-phase, 3-wire, plus ground  
AC Output to Load: 3-phase, 3- or 4-wire, plus ground  
Bypass AC Input: 3-phase, 3- or 4-wire, plus ground  
Module DC Input from Battery: 2-wire (positive and negative), plus ground
- All wiring is to be in accordance with National and Local Electrical Codes.
- Minimum overhead clearance is 2 ft. (0.6m) above the UPS.
- Top or bottom cable entry through removable access plates. Cut plate to suit conduit size.
- Control wiring and power cables must be run in separate conduits. Control wiring must be stranded tinned conductors.
- 7% maximum reflected input harmonic current and 0.92 lagging input power factor at full load with optional input filter.

**Table 6 Site planning data—600V input**

UPS Rating		AC Output Voltage	Options		Rectifier AC Input Current		Inverter or Bypass AC Output Current		Required Battery Disconnect Rating (A)	Max. Battery Current at End of Discharge (A)	Max. Heat Dissipation Full Load BTU/h (KWH)	Dimensions	Approx. Weight Unpacked	Floor Loading Concentrated Loading
kVA	kW	VAC	Input Filter	Input Xformer	Nom	Max	Nom	Max				WxDxH: in. (mm)	lb. (kg)	lb./ft. 2 (kg/m <sup>2</sup> )
300	240	600	NO	NO	291	363	289	361	600	648	56,950 (16.7)	72x35x78 (1829x889x1981)	4600 (2087)	263 (1284)
300	240	600	YES	NO	269	337	289	361	600	648	59,750 (17.5)		4770 (2164)	273 (1333)
300	240	600	NO	YES	295	369	289	361	600	648	71,250 (20.9)	96x35x78 (2438x889x1981)	6500 (2948)	279 (1362)
300	240	600	YES	YES	274	342	289	361	600	648	74,150 (21.7)		6670 (3025)	286 (1396)
300	240	208	NO	NO	292	365	833	1041	600	651	61,650 (18.1)	72x35x78 (1829x889x1981)	5050 (2291)	289 (1411)
300	240	208	YES	NO	271	338	833	1041	600	651	64,500 (18.9)		5220 (2368)	298 (1455)
300	240	208	NO	YES	297	371	833	1041	600	651	76,100 (22.3)	96x35x78 (2438x889x1981)	7150 (3243)	306 (1494)
300	240	208	YES	YES	275	344	833	1041	600	651	79,050 (23.1)		7320 (3320)	314 (1533)
400	320	600	NO	NO	387	484	385	481	800	864	75,950 (22.2)	72x35x78 (1829x889x1981)	5400 (2449)	309 (1509)
400	320	600	YES	NO	359	449	385	481	800	864	79,700 (23.3)		5570 (2527)	318 (1553)
400	320	600	NO	YES	394	492	385	481	800	864	94,950 (27.8)	96x35x78 (2438x889x1981)	7300 (3311)	313 (1528)
400	320	600	YES	YES	365	456	385	481	800	864	98,855 (28.9)		7470 (3388)	320 (1562)
400	320	208	NO	NO	390	487	1110	1388	800	868	82,200 (24.1)	72x35x78 (1829x889x1981)	6100 (2767)	348 (1701)
400	320	208	YES	NO	361	451	1110	1388	800	868	86,000 (25.2)		6270 (2844)	358 (1750)
400	320	208	NO	YES	396	495	1110	1388	800	868	101,450 (29.7)	96x35x78 (2438x889x1981)	8000 (3629)	343 (1675)
400	320	208	YES	YES	367	459	1110	1388	800	868	105,400 (30.9)		8170 (3706)	350 (1709)
<b>See Notes (p. 71):</b>			13	—	1,4,5,7,8,9,11,12		2,3,5,7,8,9,11,12		6	6,8,9,11,12	—	—	—	—

Table 7 Site planning data—480V input

UPS Rating		AC Output Voltage	Options		Rectifier AC Input Current		Inverter or Bypass AC Output Current		Required Battery Disconnect Rating (A)	Max. Battery Current at End of Discharge (A)	Max. Heat Dissipation Full Load BTU/h (KWH)	Dimensions	Approx. Weight Unpacked	Floor Loading Concentrated Loading
kVA	kW	VAC	Input Filter	Input Xformer	Nom	Max	Nom	Max				WxDxH: in. (mm)	lb. (kg)	lb./ft. 2 (kg/m <sup>2</sup> )
300	240	480	NO	NO	361	452	361	451	600	648	52,300 (15.3)	72x35x78 (1829x889x1981)	4200 (1905)	240 (1172)
300	240	480	YES	NO	335	419	361	451	600	648	55,100 (16.1)		4370 (1982)	250 (1221)
300	240	480	NO	YES	367	459	361	451	600	648	66,400 (19.4)	96x35x78 (2438x889x1981)	6100 (2767)	261 (1274)
300	240	480	YES	YES	340	425	361	451	600	648	69,300 (20.3)		6270 (2844)	269 (1313)
300	240	208	NO	NO	363	454	833	1041	600	651	56,950 (16.7)	72x35x78 (1829x889x1981)	4450 (2018)	254 (1240)
300	240	208	YES	NO	337	421	833	1041	600	651	59,750 (17.5)		4620 (2096)	264 (1289)
300	240	208	NO	YES	369	461	833	1041	600	651	71,250 (20.9)	96x35x78 (2438x889x1981)	6550 (2971)	281 (1372)
300	240	208	YES	YES	342	428	833	1041	600	651	74,150 (21.7)		6720 (3048)	288 (1406)
300	270	480	NO	NO	406	508	361	451	800	729	58,820 (17.2)	72x35x78 (1829x889x1981)	4470 (2028)	255 (1248)
300	270	480	YES	NO	376	469	361	451	800	729	58,820 (17.2)		4640 (2105)	265 (1297)
300	270	480	NO	YES	413	516	361	451	800	729	74,717 (21.9)	96x35x78 (2438x889x1981)	6100 (2767)	261 (1274)
300	270	480	YES	YES	382	477	361	451	800	729	74,717 (21.9)		6270 (2844)	269 (1313)
400	320	480	NO	NO	482	602	481	601	1000	864	69,700 (20.4)	72x35x78 (1829x889x1981)	4900 (2223)	280 (1367)
400	320	480	YES	NO	447	558	481	601	1000	864	73,450 (21.5)		5070 (2300)	290 (1416)
400	320	480	NO	YES	490	612	481	601	1000	864	88,550 (25.9)	96x35x78 (2438x889x1981)	6800 (3084)	291 (1421)
400	320	480	YES	YES	454	567	481	601	1000	864	92,400 (27.1)		6970 (3162)	299 (1460)
400	320	208	NO	NO	484	605	1110	1388	1000	868	75,950 (22.2)	72x35x78 (1829x889x1981)	5150 (2336)	294 (1435)
400	320	208	YES	NO	449	561	1110	1388	1000	868	79,700 (23.3)		5320 (2413)	304 (1484)
400	320	208	NO	YES	492	615	1110	1388	1000	868	94,950 (27.8)	96x35x78 (2438x889x1981)	7250 (3289)	311 (1518)
400	320	208	YES	YES	456	570	1110	1388	1000	868	98,850 (28.9)		7420 (3366)	318 (1553)
400	360	480	NO	NO	542	677	481	601	1000	972	78,450 (23.0)	72x35x78 (1829x889x1981)	5100 (2313)	291 (1421)
400	360	480	YES	NO	502	628	481	601	1000	972	82,600 (24.2)		5270 (2390)	301 (1470)
400	360	480	NO	YES	551	688	481	601	1000	972	99,600 (29.2)	96x35x78 (2438x889x1981)	7600 (3447)	326 (1592)
400	360	480	YES	YES	510	638	481	601	1000	972	103,950 (30.4)		7770 (3524)	333 (1626)
450	360	480	NO	NO	542	677	541	677	1000	972	78,450 (23.0)	72x35x78 (1829x889x1981)	5100 (2313)	291 (1421)
450	360	480	YES	NO	502	628	541	677	1000	972	82,600 (24.2)		5270 (2390)	301 (1470)
450	360	480	NO	YES	551	688	541	677	1000	972	99,600 (29.2)	96x35x78 (2438x889x1981)	7600 (3447)	326 (1592)
450	360	480	YES	YES	510	638	541	677	1000	972	103,950 (30.4)		7770 (3524)	333 (1626)
<b>See Notes (p. 71):</b>			13	—	1,4,5,7,8,9,11,12		2,3,5,7,8,9,11,12		6	6,8,9,11,12	—	—	—	—

**Table 8 Site planning data—208V input**

UPS Rating		AC Output Voltage	Options		Rectifier AC Input Current		Inverter or Bypass AC Output Current		Required Battery Disconnect Rating (A)	Max. Battery Current at End of Discharge (A)	Max. Heat Dissipation Full Load BTU/h (kWH)	Dimensions	Approx. Weight Unpacked	Floor Loading Concentrated Loading
kVA	kW	VAC	Input Filter	Input Xformer	Nom	Max	Nom	Max				WxDxH: in. (mm)	lb. (kg)	lb./ft. <sup>2</sup> (kg/m <sup>2</sup> )
300	240	208	NO	NO	847	1059	833	1041	600	651	66,400 (19.4)	72x35x78 (1829x889x1981)	5400 (2449)	309 (1509)
300	240	208	YES	NO	785	982	833	1041	600	651	69,300 (20.3)		5570 (2527)	318 (1553)
300	240	208	NO	YES	861	1077	833	1041	600	651	81,000 (23.7)		7500 (3402)	321 (1567)
300	240	208	YES	YES	798	998	833	1041	600	651	84,000 (24.6)	96x35x78 (2438x889x1981)	7670 (3479)	329 (1606)
<b>See Notes (p. 71):</b>			13	—	1,4,5,7,8,9,11,12		2,3,5,8,9,11,12		6	6,8,9,11,12	—	—	—	—



**NOTES**





# Ensuring The High Availability Of Mission-Critical Data And Applications.

**Emerson Network Power, the global leader in enabling business-critical continuity, ensures network resiliency and adaptability through a family of technologies—including Liebert power and cooling technologies—that protect and support business-critical systems. Liebert solutions employ an adaptive architecture that responds to changes in criticality, density and capacity. Enterprises benefit from greater IT system availability, operational flexibility and reduced capital equipment and operating costs.**

## **Technical Support / Service Web Site**

[www.liebert.com](http://www.liebert.com)

## **Monitoring**

[liebert.monitoring@emerson.com](mailto:liebert.monitoring@emerson.com)

800-222-5877

Outside North America: +800 1155 4499

## **Single-Phase & Three-Phase UPS**

[liebert.upstech@emerson.com](mailto:liebert.upstech@emerson.com)

800-222-5877

Outside North America: +800 1155 4499

## **Environmental Systems**

800-543-2778

Outside the United States: 614-888-0246

## **Locations**

### **United States**

1050 Dearborn Drive

P.O. Box 29186

Columbus, OH 43229

### **Europe**

Via Leonardo Da Vinci 8

Zona Industriale Tognana

35028 Piove Di Sacco (PD) Italy

+39 049 9719 111

Fax: +39 049 5841 257

### **Asia**

29/F, The Orient Square Building

F. Ortigas Jr. Road, Ortigas Center

Pasig City 1605

Philippines

+63 2 687 6615

Fax: +63 2 730 9572

While every precaution has been taken to ensure the accuracy and completeness of this literature, Liebert Corporation assumes no responsibility and disclaims all liability for damages resulting from use of this information or for any errors or omissions.

© 2007 Liebert Corporation

All rights reserved throughout the world. Specifications subject to change without notice.

® Liebert is a registered trademark of Liebert Corporation.

All names referred to are trademarks or registered trademarks of their respective owners.

SL-25130\_REV04\_07-09

## **Emerson Network Power.**

The global leader in enabling *Business-Critical Continuity*.

■ **AC Power**

■ Embedded Computing

■ Outside Plant

■ Racks & Integrated Cabinets

■ Connectivity

■ Embedded Power

■ Power Switching & Controls

■ Services

■ DC Power

■ Monitoring

■ Precision Cooling

■ Surge Protection

## **EmersonNetworkPower.com**

*Business-Critical Continuity*, Emerson Network Power and the Emerson Network Power logo are trademarks and service marks of Emerson Electric Co.

©2007 Emerson Electric Co.