



POWER PROTECTION

## Series 600 and 600T UPS

Single-Module Three Phase  
150 kVA to 1000 kVA; 60 Hz

Operation & Maintenance  
Manual

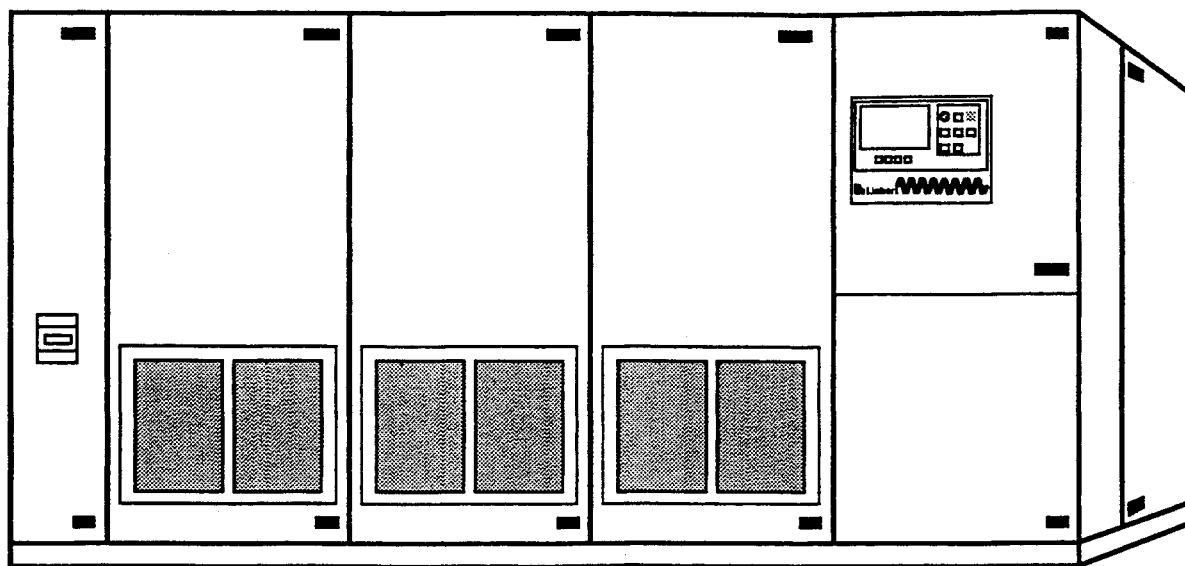

---

---

---

# TABLE OF CONTENTS

<b>IMPORTANT SAFETY INSTRUCTIONS</b> .....	<b>1</b>
<b>ABOUT THIS MANUAL</b> .....	<b>2</b>
<b>1.0 INTRODUCTION</b>	
1.1 System Description .....	3
1.2 Reliability .....	5
1.3 Safety Precautions .....	7
1.4 Modes Of Operation .....	8
1.4.1 Normal (Load on UPS) .....	8
1.4.2 Input Power Failure .....	8
1.4.3 Recharge .....	8
1.4.4 Overload .....	8
1.4.5 Bypass (Internal) .....	8
1.4.6 Maintenance Bypass .....	8
1.4.7 Off-Battery .....	8
1.5 Operator Controls .....	9
1.6 Single Line Diagram .....	10
1.7 Options .....	11
<b>2.0 THEORY OF OPERATION</b>	
2.1 General Component Descriptions .....	12
2.2 Detailed Component Descriptions .....	14
2.2.1 Controls .....	14
2.2.2 Rectifier/Charger .....	15
2.2.3 Battery Charging Circuit .....	16
2.2.4 Inverter .....	17
2.2.5 Static Bypass .....	18
<b>3.0 OPERATION</b>	
3.1 Display Screen and Operator Controls .....	21
3.1.1 Master Menu Screen .....	27
3.1.2 Monitor/Mimic Display Screen .....	29
3.1.3 Walk-In Display Screen .....	33
3.1.4 Status Reports Screens .....	34
3.1.5 System Configuration Screens .....	40
3.1.6 Alarm Limit Settings Screen .....	47
3.1.7 Load Transfer Procedures .....	49
3.1.8 Start-Up Procedures Screen .....	50
3.1.9 Shutdown Procedures Screen .....	51
3.1.10 Battery Time Screen .....	52
3.1.11 Meter Calibration Screen .....	55
3.1.12 Battery Equalize Screen .....	56
3.1.13 Alarm and Status Messages .....	57
3.1.14 Communication Interfaces .....	63

---

3.2	Modes of Operation . . . . .	66
3.2.1	Load on Bypass . . . . .	66
3.2.2	Ok To Transfer . . . . .	67
3.2.3	Momentary Overloads . . . . .	69
3.2.4	Input Power Failure (Load on Battery). . . . .	70
3.2.5	Off Battery . . . . .	71
3.2.6	Local Emergency Module Off (LEMO) . . . . .	72
3.2.7	Remote Emergency Power Off (REPO) . . . . .	73
3.2.8	Module Shutdown. . . . .	74
3.2.9	Maintenance Bypass. . . . .	75
3.3	Manual Procedures. . . . .	77
3.3.1	Start-Up Procedures. . . . .	78
3.3.2	Load Transfer Procedures . . . . .	83
3.3.3	Shutdown Procedures. . . . .	85
3.4	Automatic Operations . . . . .	88
3.4.1	Overloads (Without Transfer) . . . . .	88
3.4.2	Automatic Transfers to Bypass . . . . .	89
3.4.3	Automatic Retransfers to UPS. . . . .	89
3.4.4	Automatic Emergency Module Off. . . . .	90
<b>4.0</b>	<b>MAINTENANCE</b>	
4.1	Safety Precautions . . . . .	91
4.2	Liebert Customer Service and Support. . . . .	93
4.3	Routine Maintenance . . . . .	94
4.3.1	Record Log. . . . .	94
4.3.2	Air Filters . . . . .	94
4.3.3	Battery Maintenance . . . . .	95
4.3.4	Torque Requirements. . . . .	100
4.4	Detection of Trouble . . . . .	100
4.5	Reporting a Problem. . . . .	101
4.6	Corrective Actions . . . . .	101
4.7	Recommended Test Equipment. . . . .	101
<b>5.0</b>	<b>SPECIFICATIONS AND RATINGS</b>	
5.1	Rating . . . . .	102
5.2	Environmental Conditions . . . . .	103
5.3	Adjustments . . . . .	104
5.4	Battery Operation. . . . .	104
5.5	Electrical Specifications . . . . .	105

---

## FIGURES

Figure 1	Single Module 150 and 225 kVA UPS	3
Figure 2	Single Module 338 kVA, 480/480 VAC, UPS	4
Figure 3	Single Module 400 to 750 kVA UPS	5
Figure 4	Series 600 UPS Operator Controls and Display Screen with Example of the Monitor/Mimic Screen	9
Figure 5	Single Line Diagram	10
Figure 6	UPS Block Diagram	12
Figure 7	Operator Controls, 150 to 225 kVA (left) and 300 to 375 kVA (right)	22
Figure 8	Operator Controls, 338 to 1000 kVA (SCR-Based Products)	23
Figure 9	Switches Behind Control Panel Door of 338-1000 kVA (SCR-Based Products)	24
Figure 10	Series 600 UPS Operator Control Panel	25
Figure 11	Menu Tree	26
Figure 12	Master Menu Screen	27
Figure 13	Monitor/Mimic Display Screen	29
Figure 14	Monitor/Mimic Display Screen Example: Normal Power Flow	31
Figure 15	Monitor/Mimic Display Screen Example: Utility Fail	31
Figure 16	Monitor/Mimic Display Screen Example: Load On Bypass, UPS Module On and Charging Battery	32
Figure 17	Monitor/Mimic Display Screen Example: Load On Bypass, UPS Module Off	32
Figure 18	Walk-In Display Screen During Start-Up	33
Figure 19	Status Reports Screen	34
Figure 20	Present Status Report Screen	35
Figure 21	Event History Report Screen	36
Figure 22	History Status Report Screen	37
Figure 23	Battery Cycle Monitor Screen	38
Figure 24	Battery Cycle Monitoring Summary Screen	39
Figure 25	Typical Data on Discharge Cycles of 91 to 240 Seconds Duration During the Recording Period	39
Figure 26	System Configuration Screen	40
Figure 27	Date Screen	41
Figure 28	Time Screen	42
Figure 29	Auto Dial Setting Screen	43
Figure 30	Modem Baud Rate	44
Figure 31	Maximum Auto-Retransfer Attempts Screen	45
Figure 32	Alarm Limit Settings Screen	47
Figure 33	Load Transfer Procedures Screen	49
Figure 34	Start-Up Procedures Screen	50
Figure 35	Shutdown Procedures Screen	51
Figure 36	Battery Time Screen Example - 15 Minute Discharge	52
Figure 37	Battery Time Screen Example - 45 Minute Discharge	53
Figure 38	Tolerance Range of Values for Calculated Battery Times	54
Figure 39	Meter Calibration Screen	55
Figure 40	Battery Equalize Screen	56
Figure 41	Status and Alarm Message Areas	57
Figure 42	Load on Bypass (UPS Not Available)	66
Figure 43	Load on Bypass (UPS Available)	67
Figure 44	Load on UPS (Bypass Available)	68
Figure 45	Momentary Overload (Through Static Bypass Switch)	69
Figure 46	Input Power Fail (Load on Battery)	70

---

Figure 47	Load on UPS (Battery not Available) .....	71
Figure 48	Local Emergency Module Off (LEMO) .....	72
Figure 49	Remote Emergency Power Off (REMO) .....	73
Figure 50	Module Shutdown .....	74
Figure 51	Load on Maintenance Bypass (Two Breakers) .....	75
Figure 52	Load on Maintenance Bypass (Three Breakers) .....	76
Figure 53	Optional Maintenance Bypass Cabinet for 150 and 225 kVA .....	80
Figure 54	Start-Up Procedures Screen .....	81
Figure 55	Load Transfer Procedures Screen .....	83
Figure 56	Shutdown Procedures Screen .....	85
Figure 57	Current Versus Time Curve of Overload Capacity .....	88
Figure 58	Output Power Envelope for 0.8 pf Rated Units .....	102

## TABLES

Table 1	Alarm Messages - Meaning and Corrective Action .....	59
Table 2	Alarm Messages - Summary .....	62
Table 3	Series 600 Terminal Commands .....	65
Table 4	Torque Specifications .....	100
Table 5	Recommended Test Equipment and Tools .....	101

---

## IMPORTANT SAFETY INSTRUCTIONS

---

### Save These Instructions.

This manual contains important instructions that should be followed during installation and maintenance of your Series 600 UPS and batteries.



#### **WARNING**

**EXERCISE EXTREME CARE WHEN HANDLING UPS CABINETS TO AVOID EQUIPMENT DAMAGE OR INJURY TO PERSONNEL. REFER TO SEPARATE INSTALLATION MANUAL FOR EQUIPMENT HANDLING INFORMATION AND INSTALLATION PROCEDURES.**

**FOLLOW ALL BATTERY SAFETY PRECAUTIONS IN 4.0 - MAINTENANCE WHEN INSTALLING, CHARGING, OR SERVICING BATTERIES. IN ADDITION TO THE HAZARD OF ELECTRIC SHOCK, GAS PRODUCED BY BATTERIES CAN BE EXPLOSIVE AND SULFURIC ACID CAN CAUSE SEVERE BURNS.**

**IN CASE OF FIRE INVOLVING ELECTRICAL EQUIPMENT USE ONLY CARBON DIOXIDE FIRE EXTINGUISHERS, OR OTHERS APPROVED FOR USE IN ELECTRICAL FIRE FIGHTING.**

**EXTREME CAUTION IS REQUIRED WHEN PERFORMING MAINTENANCE.**

**BE CONSTANTLY AWARE THAT THE UPS SYSTEM CONTAINS HIGH DC AS WELL AS AC VOLTAGES. WITH INPUT POWER OFF AND THE BATTERY DISCONNECTED, HIGH VOLTAGE AT FILTER CAPACITORS AND POWER CIRCUITS SHOULD BE DISCHARGED WITHIN 30 SECONDS. HOWEVER, IF A POWER CIRCUIT FAILURE HAS OCCURRED, YOU SHOULD ASSUME THAT HIGH VOLTAGE MAY STILL EXIST AFTER SHUTDOWN. CHECK WITH A VOLTMETER BEFORE MAKING CONTACT.**

**AC VOLTAGE WILL REMAIN ON THE BYPASS AND OUTPUT CIRCUIT BREAKERS, AND THE STATIC BYPASS SWITCH, UNLESS ASSOCIATED EXTERNAL CIRCUIT BREAKERS ARE OPENED.**

**CHECK FOR VOLTAGE WITH BOTH AC AND DC VOLTMETERS PRIOR TO MAKING CONTACT.**

**WHEN THE UPS SYSTEM IS UNDER POWER, BOTH THE OPERATOR AND ANY TEST EQUIPMENT MUST BE ISOLATED FROM DIRECT CONTACT WITH EARTH GROUND AND THE UPS CHASSIS FRAME BY USING RUBBER MATS.**

**SOME COMPONENTS WHEN THE CABINETS ARE NOT CONNECTED TO CHASSIS GROUND. ANY CONTACT BETWEEN FLOATING CIRCUITS AND THE CHASSIS IS A LETHAL SHOCK HAZARD. EXERCISE CAUTION THAT THE TEST INSTRUMENT EXTERIOR DOES NOT MAKE CONTACT EITHER PHYSICALLY OR ELECTRICALLY WITH EARTH GROUND.**

---

## ABOUT THIS MANUAL

---

**Welcome to the Liebert Series 600 Uninterruptible Power Supply (UPS) Operation and Maintenance Manual for a single module system.** The Series 600 UPS is easy to operate and maintain. Read this manual thoroughly before operating or performing maintenance on your Series 600 UPS.

The manual is organized so that information can be found quickly. Each major topic is separated by sections, and the Table of Contents contains major headings within each section. The names of the sections and their contents are described below.

- **1.0 - Introduction** is a summary of the unique features and benefits of the Series 600. It includes the design principles and standards that Liebert follows in the manufacture of each unit, a description of the Series 600, and an overview of its functions.
- **2.0 - Theory of Operation** is an explanation of the major circuit groups of the Series 600 UPS. This section is for individuals who want to know both the basics and the specifics of each major component. The text explains how the UPS handles electrical disturbances and interruptions.
- **3.0 - Operation** is written for facility personnel responsible for the operation of the system. It details the procedures required to start-up the UPS, to transfer the load between the available sources, and to shutdown the system. Both manual and automatic operations are described. Operator controls and displays, including the solid state liquid crystal display (LCD) screen, are illustrated and explained.
- **4.0 - Maintenance** lists routine maintenance checks and helps the user pinpoint and quickly resolve problems if they arise.
- **5.0 - Specifications and Ratings** gives detailed specifications about the Series 600 UPS. This technical information is of use to installing contractors, engineers, and service personnel.

If you require assistance for any reason, call the toll-free Liebert Customer Service & Support number; 1-800-543-2378. For CS&S to assist you expediently, please have the following information available:

Part Number: \_\_\_\_\_  
Serial Number: \_\_\_\_\_  
kVA Rating: \_\_\_\_\_  
Date Purchased: \_\_\_\_\_  
Date Installed: \_\_\_\_\_  
Location: \_\_\_\_\_  
Input Voltage: \_\_\_\_\_  
Output Voltage: \_\_\_\_\_  
Battery Reserve Time: \_\_\_\_\_



---

## 1.0 INTRODUCTION

---

### 1.1 System Description

The role of the UPS system is to supply uninterruptible, clean power to the critical load. It maintains a full-voltage, low-distortion output even if the utility source power sags or becomes distorted. If there is an outage of the source power, the UPS maintains power to the load until an alternate source of power is activated, or until the original power source is restored. If input AC power is not restored, the UPS maintains the load (with the battery plant) long enough that the critical equipment can be shut down in an orderly manner. The Series 600 UPS module displays the rate of battery discharge and calculates the amount of battery time remaining based on actual load conditions. The time that the battery will maintain the load depends on the size of the battery backup plant and the size of the load.

The system control logic automatically manages critical bus operation. System logic is resident in Application Specific Integrated Circuits (ASICs) for precise control and improved reliability.

If the critical load current exceeds the rated load of the Series 600 UPS, the control logic determines the magnitude of the overload and reacts appropriately. Overloads are usually the result of inrush current demands. The UPS system supports loads that are 150% of the rated load for up to 30 seconds, 125% of the rated load for up to ten minutes, and 104% of the rated load indefinitely.

**Figure 1 Single Module 150 and 225 kVA UPS**

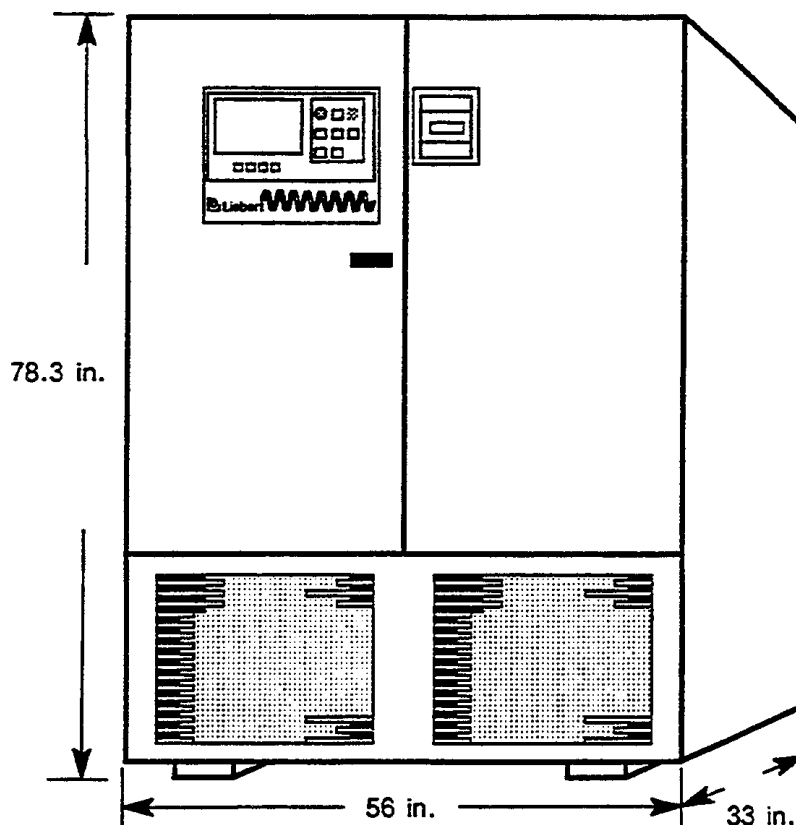

300 and 375 kVA UPS cabinets are 72 x 35 x 79 inches (W x D x H).  
Refer to drawings for optional cabinets not shown.

If the load surpasses the overload capacity of the UPS at any time, the load is automatically connected to bypass without interruption. When the load returns to within the UPS rating, it is either automatically or manually returned (retransferred) to the UPS. How and when the load is returned to the UPS depends on several factors: how long the overload lasted, how many overload conditions occurred before transfer, whether there is an imminent failure of any part of the UPS, etc. Refer to **3.4 - Automatic Operations**.

In the unlikely event of a fault within the UPS, the system control logic, which continuously monitors all critical circuits within the UPS system, transfers the load to bypass without interruption and simultaneously sets off local and remote alarms. For a few specified faults, the UPS is shut down. The UPS system can be manually returned to service when the fault has been corrected.

The Series 600 UPS display system provides precise monitoring of the UPS, fast alarm response, and quick troubleshooting. For easy manual operations, menu-driven software provides access to several step-by-step help screens. All operator functions are performed using menu-prompted displays and a minimum number of operator controls. The UPS system includes external communication capability with both automatic dial-out and dial-in features for early warning and diagnosis of abnormal conditions.

The system firmware allows the operator, or Liebert Customer Service and Support, to enter application specific information. Overload, overvoltage, battery discharge, and shutdown limits can be user-set. In effect, the system can be tailored for each site.

The UPS system protects critical equipment from source power disturbances and outages, load faults, and UPS malfunctions. This triple protection virtually eliminates computer and computing equipment downtime as a result of utility source power problems.

**Figure 2 Single Module 338 kVA, 480/480 VAC, UPS**

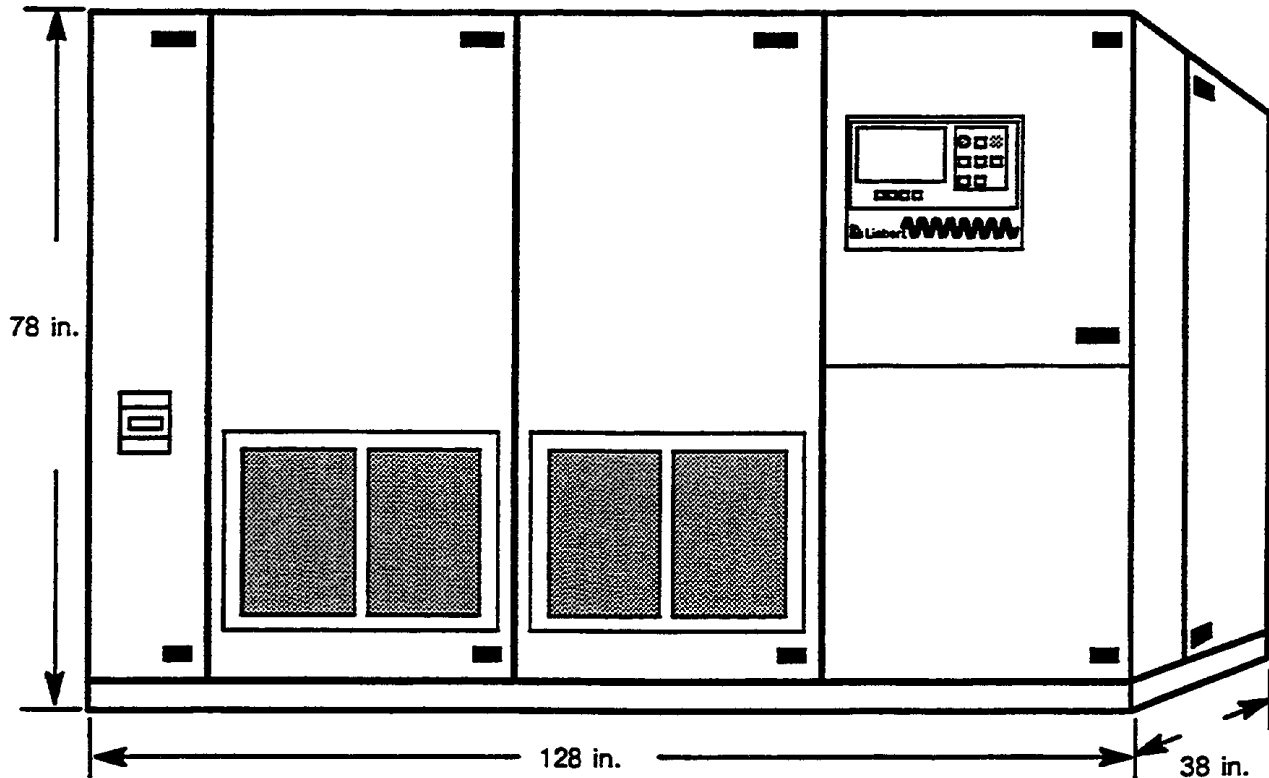

Refer to drawings for 208 VAC dimensions.

## 1.2 Reliability

Uninterruptible Power Systems are becoming a necessity for all types of businesses. The substantial investments made to manage information assets mandate using the most **RELIABLE** system available to supply power to computers and process control equipment.

Liebert Large UPS systems have a field-proven record of experience and reliability through millions of hours of operation. Our Quality Assurance program is certified to the requirements of ISO 9001. In addition, Liebert Large UPS systems are either UL or ETL listed. All equipment—and components are manufactured within applicable UL, NEC, NEMA, ANSI, IEEE, and CSA standards and guidelines.

The keys to reliability in the design of the UPS system are conservatively rated components, eliminating single point failure modes, minimizing transfers to bypass, understandable operator controls, and easy access for maintenance and repair. While the Liebert Large UPS systems incorporate these design factors, we recognize that the reliability of UPS systems is also a function of proper installation, operation, and maintenance.

Many failures of UPS systems properly matched to handle the load are due to improper installation. Liebert Customer Service and Support thoroughly inspects the installation of every one of our units to make sure that it is installed properly and operates within performance specifications. Another factor in reliability is proper operation. The Series 600 UPS is designed with easy-to-follow, prompted instructions to help prevent operator error. Through proper operation and maintenance after the installation, the inherent reliability of the system is maintained.

**Figure 3 Single Module 400 to 750 kVA UPS**

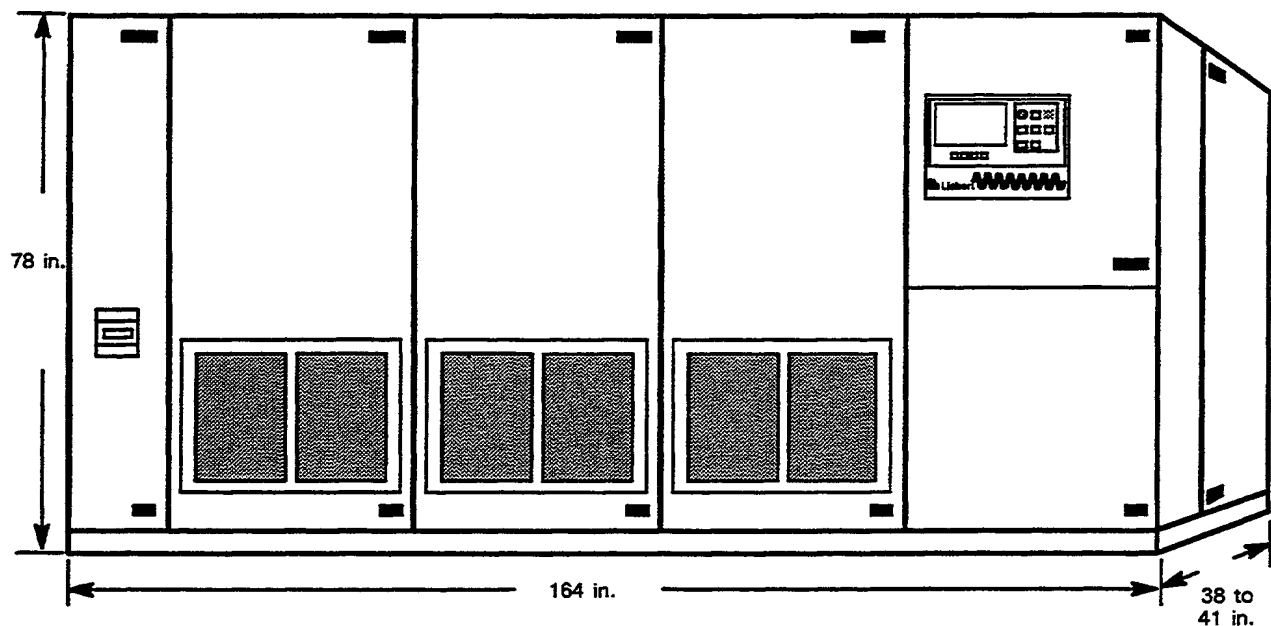

Cabinet depth of 400 and 500 kVA modules is 38 inches.  
Cabinet depth of 625 and 750 (HL) kVA modules is 41 inches.

Refer to drawings for 208 VAC dimensions (338 to 500 kVA)  
and for 750 (LL) and 1000 kVA modules (not shown).

**Note:**

HL = 240 cell battery  
LL = 180 cell battery

Modes of operation that utilize less reliable components have been minimized. For example, the module has the capability to clear substantial overloads through the solid state static bypass switch without transfer to the bypass source. Minimizing transfers to bypass enhances the system reliability.

---

The control logic is isolated from heat generating components to assure optimal operating temperatures.

The reliability of the critical bus is the key consideration in the design and manufacture of all Liebert Large UPS systems. By using this manual you should be able to oversee the installation as well as operate and perform routine maintenance on the Series 600 UPS. If you ever need help, call Liebert Customer Service and Support (24 hours a day at 1-800-543-2378). The superior design and construction of the units combined with your attention to proper installation, operation, and periodic maintenance ensures that your business operations receive the best possible protection from electrical disturbances and outages.

---

## 1.3 Safety Precautions

Read this manual thoroughly, paying special attention to the sections that apply to you, before working with the UPS. Also read the battery manufacturer's manual before working on or near the battery.

Under typical operation and with all UPS doors closed, only normal safety precautions are necessary. The area around the UPS system and Battery should be kept free from puddles of water, excess moisture, or debris.

Special safety precautions are required for procedures involving handling, installation, and maintenance of the UPS system or the battery. Observe precautions in the separate **Installation Manual** before handling or installing the UPS system. Observe precautions in **4.0 - Maintenance** before as well as during performance of all maintenance procedures. Observe all battery safety precautions in **4.0 - Maintenance** before working on or near the battery.

**This equipment contains several circuits that are energized with high voltage.** Only test equipment designated for troubleshooting should be used. This is particularly true for oscilloscopes. Always check with an AC and DC voltmeter to ensure safety before making contact or using tools. Even when the power is turned Off, dangerously high potentials may exist at the capacitor banks. Observe all battery precautions when near the battery for any reason.

**ONLY qualified service personnel should perform maintenance on the UPS system.** When performing maintenance with any part of the equipment under power, service personnel and test equipment should be standing on rubber mats. The service personnel should wear insulating shoes for isolation from direct contact with the floor (earth ground).

Unless all power is removed from the equipment, one person should never work alone. A second person should be standing by to assist and summon help in case an accident should occur. This is particularly true when work is performed on the battery.

Three types of messages are used throughout the manual to stress important text. Carefully read the text below each Warning, Caution, and Note and use professional skills and prudent care when performing the actions described by that text

A **Warning** signals the presence of a possible serious, life-threatening condition. For example:



### WARNING

**LETHAL VOLTAGES MAY BE PRESENT WITHIN THIS UNIT EVEN WHEN IT IS APPARENTLY NOT OPERATING. OBSERVE ALL CAUTIONS AND WARNINGS IN THIS MANUAL FAILURE TO DO SO COULD RESULT IN SERIOUS INJURY OR DEATH. DO NOT WORK ON OR OPERATE THIS EQUIPMENT UNLESS YOU ARE FULLY QUALIFIED TO DO SO!! NEVER WORK ALONE.**

A **Caution** indicates a condition that could seriously damage equipment and possibly injure personnel. For example:



### CAUTION

**Make sure you understand the proper sequence before operating any circuit breaker. Operating a Maintenance Bypass circuit breaker out of sequence could cut off power to the critical load.**

A **Note** emphasizes important text. If the note is not followed, equipment could be damaged or may not operate properly. For example:



### NOTE

*If the UPS system has a blown fuse, the cause should be determined before you replace the fuse. Contact Liebert Customer Service and Support.*

---

## 1.4 Modes Of Operation

Refer to **Figure 5** and **3.0 - Operation** for more details.

### 1.4.1 Normal (Load on UPS)

The utility AC source provides power to the rectifier/charger. The rectifier/charger converts the utility AC power to DC and supplies DC power to the inverter while simultaneously float charging the battery plant. The UPS inverter converts DC to AC and furnishes AC power to the critical load.

### 1.4.2 Input Power Failure

If the utility source power fails or is outside the acceptable range, the battery plant becomes the primary supplier of DC power to the inverter.

### 1.4.3 Recharge

After the utility source power is restored, or an alternate power source becomes available, the rectifier/charger slowly walks-in to once again power the inverter and recharge the battery plant.

### 1.4.4 Overload

Overloads in critical systems may be caused by inrush currents during connected equipment start up or by faults in the critical load. The Liebert Series 600 UPS system can maintain full output voltage regulation while sustaining the following overloads:

- Up to 150% for 30 seconds
- Up to 125% for 10 minutes
- Up to 104% for an indefinite period
- Up to 1000% of the rated current can be supplied from the bypass source through the static switch for clearing momentary (up to 40 milliseconds) faults above 155% of rated current.

The critical load remains on the UPS inverter for the above conditions. If the UPS overload capacity is exceeded, an automatic transfer to bypass is initiated which closes the bypass circuit breaker and opens the UPS inverter output circuit breaker. Refer to **2.0 - Theory of Operation** for more details on the static switch and load transfers.

Whenever you have an overload condition, you should determine the cause of the overload.

### 1.4.5 Bypass (Internal)

The UPS control logic initiates an automatic transfer to the bypass source if the overload-current-versus-time curve is exceeded or if specified UPS system faults occur. You can also manually transfer the load to the bypass (without interruption) if you must take the UPS module out of service for maintenance.

The internal maintenance bypass will allow most key components and operating notes to be checked without disturbing the critical bus. However, certain key power-carrying components, such as the output and bypass circuit breakers, will require complete system shutdown or isolation through an external maintenance bypass cabinet for 100% service.

### 1.4.6 Maintenance Bypass

The installation of a Maintenance Bypass cabinet, panelboard or switchboard is recommended to allow you to totally isolate the UPS from all power sources. Use of the Maintenance Bypass is described in **3.0 - Operation**.

### 1.4.7 Off-Battery

The battery plant can be disconnected from the rectifier/charger by using an external Module Battery Disconnect (MBD circuit breaker). The UPS continues to function normally, though it does not have power outage back-up capability until the battery plant is reconnected.

## 1.5 Operator Controls

The Liebert Series 600 UPS system is equipped with a microprocessor-based Operator Interface Display Screen and System Control Panel designed for convenient and reliable operation.

The front panel location of the monitoring and control system enables the user to quickly identify the current status of the UPS and to perform most of the manual operations. The operator display screen is driven by an easy-to-follow menu-prompted software program that controls and monitors the UPS system.

Complete details of how to interpret the displays and use the controls are in **3.0 - Operation**.

**Figure 4 Series 600 UPS Operator Controls and Display Screen with Example of the Monitor/Mimic Screen**

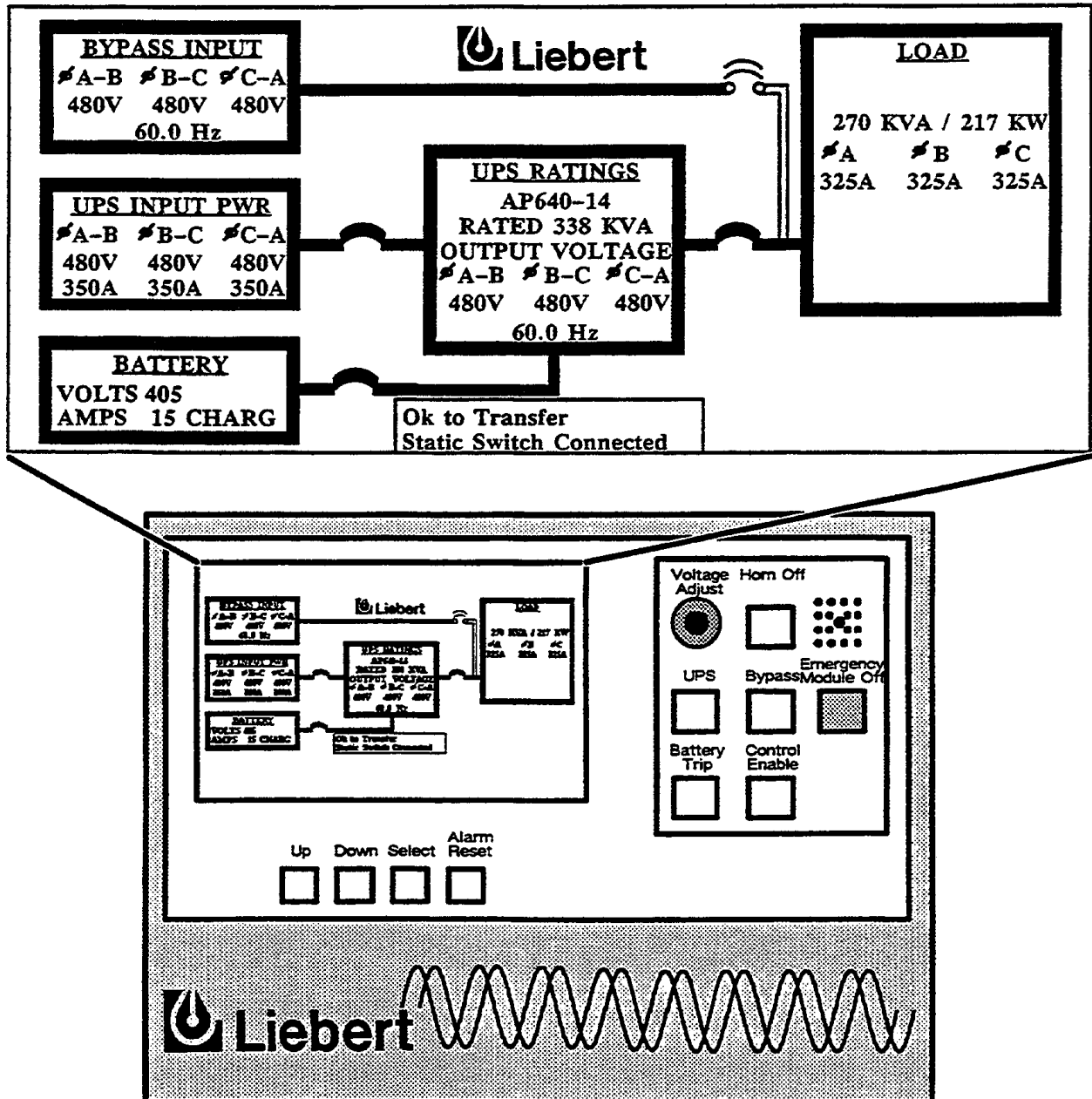

## 1.6 Single Line Diagram

The major functional blocks of the UPS are shown below. **2.0 - Theory of Operation** describes how each block performs its functions.

The manual controls shown include the input circuit breaker (CB), Control Power switch, Static Switch Disconnects, and the module battery (dis)connect (MBD) circuit breaker. The output and bypass circuit breakers are motor operated. The motors can be energized through manual front panel controls.

The AC power source and bypass feeder circuit breakers, located outside the UPS cabinet, are not shown. Procedures for operating controls and circuit breakers are in **3.0 - Operation**.

Figure 5 Single Line Diagram

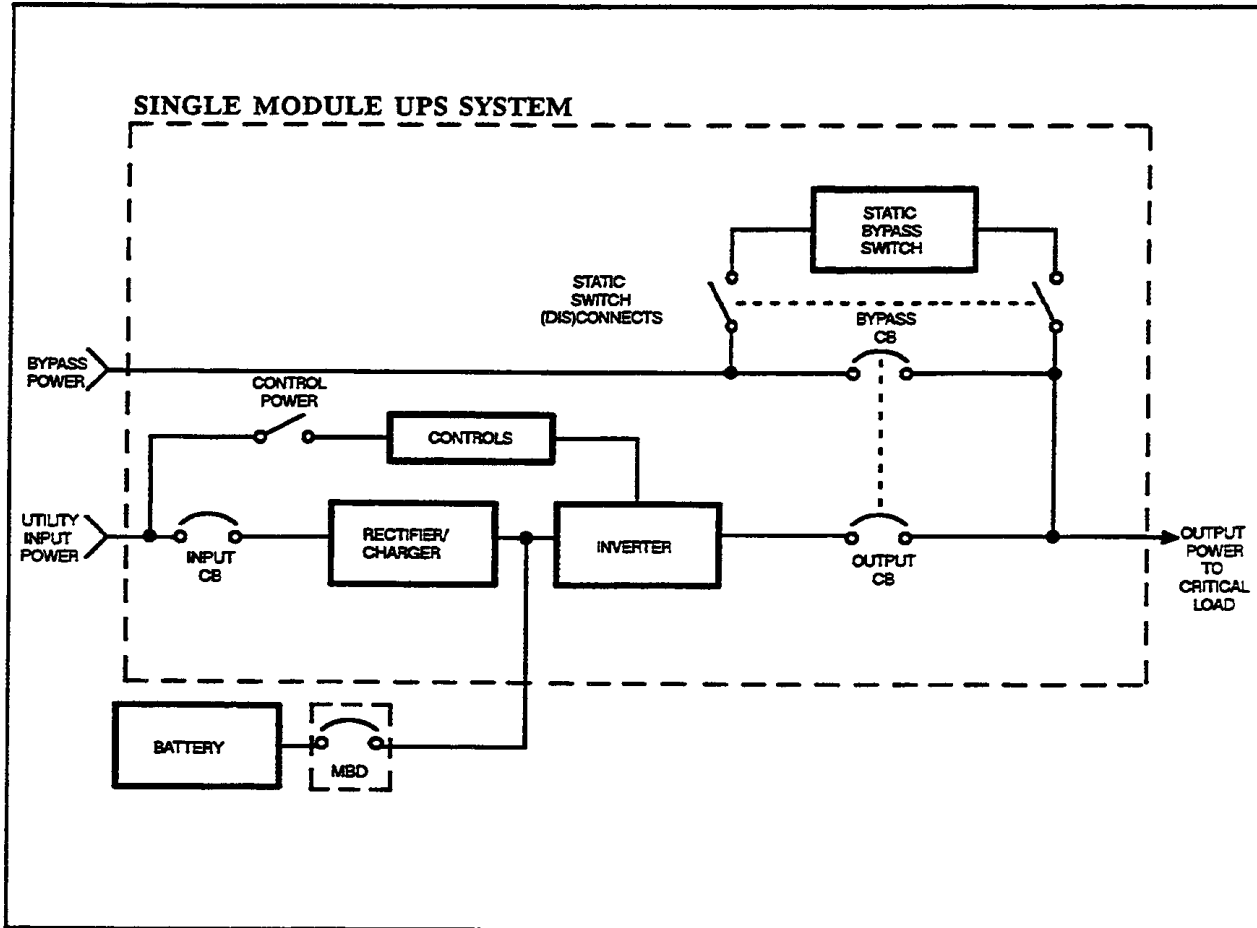



---

## 1.7 Options

A number of standard pre-designed options are available from Liebert for your UPS system. Described below are the most frequently provided options. **Note that the battery items (1-3) are required to complete the UPS system.** The remaining options provide improved system performance or convenience.

### 1. Battery

The batteries provide power in the event of a power outage. The Liebert UPS can use a variety of battery types, provided the battery plant is designed for the UPS DC voltage range and the load requirements of your application.

### 2. Battery Racks or Cabinets

The battery racks are specifically designed for stationary service batteries. They are painted with electrolyte-resistant paint for corrosion resistance. Battery cabinets are available for 150 to 375 kVA modules.

### 3. Module Battery Disconnect

The UPS system utilizes a separate Module Battery Disconnect for remotely located batteries. A sensing circuit in the UPS module, set at the battery low voltage limit, trips the Module Battery Disconnect to safeguard the Battery from excessive discharge. The Module Battery Disconnect has an undervoltage release mechanism designed to ensure that during any shut-down or failure mode all battery potential is removed from the UPS system.

### 4. Input Distortion Filter

This filter reduces reflected input current harmonic distortion to less than 4% THD (7% THD for 150 to 375 kVA modules). It is factory installed within the UPS. This filter also improves the input power factor to better than 0.91 lagging.

### 5. Isolation Transformers

For 150 to 375 kVA modules, an optional rectifier input isolation transformer is available in a matching transformer cabinet. Input isolation is standard in the SCR-based modules (338 kVA and up). A bypass isolation transformer is also available and will fit into the same matching cabinet.

### 6. Maintenance Bypass Cabinet

A Maintenance Bypass line is required to supply to the critical load when maintenance is required on UPS circuit breakers. Refer to **3.0 - Operation**. A matching Maintenance Bypass Cabinet is available for 150 and 225 kVA modules. A separate Maintenance Bypass Panel-board is used with 300 kVA and larger units.

### 7. Remote Modem/Terminal/Monitor/ Printer

The 150 to 375 kVA systems can be ordered with an interface board and ports for remote communications via modem or RS-232 port. The board and ports are standard on the SCR-based 338 kVA and larger.

### 8. SiteScan/Sitemaster and SNMP Monitoring Systems

Liebert manufactures central monitoring systems that automatically display key UPS measurements and alarms, as well as data from a variety of sensors. These monitoring systems signal alarms so corrective action can be taken. Events and data can be printed in hard copy. Data can be logged for analysis. The SiteScan/Sitemaster interface circuitry is optional on 160 to 375 kVA modules, standard on larger units. An SNMP option package is available to enable you to monitor the Series 600 with standard network management software.

### 9. Remote Monitor Panel

The UPS system may also be provided with an optional Remote Monitor Panel. This Panel provides eight LED indicators and may be placed at a convenient location near the critical load. A functional description of the Remote Monitor Panel is provided in **3.0 - Operation** of this manual.

### 10. Customer Alarm Interface

This optional interface board allows the input and display of 8 alarms from customer-supplied contacts, each with a customer-selected name of up to 16 characters. The following attributes can be user programmed for each alarm: latching summary, freeze history, sound horn, auto-dial, and time delay (0 to 999.9 seconds).

## 2.0 THEORY OF OPERATION

### 2.1 General Component Descriptions

The UPS system is made up of the equipment necessary to provide computer grade AC power continuously to a critical load, even when there is an interruption of the utility line voltage. It consists of the UPS module and a back-up battery plant. Refer to **Figure 6**.

Figure 6 UPS Block Diagram

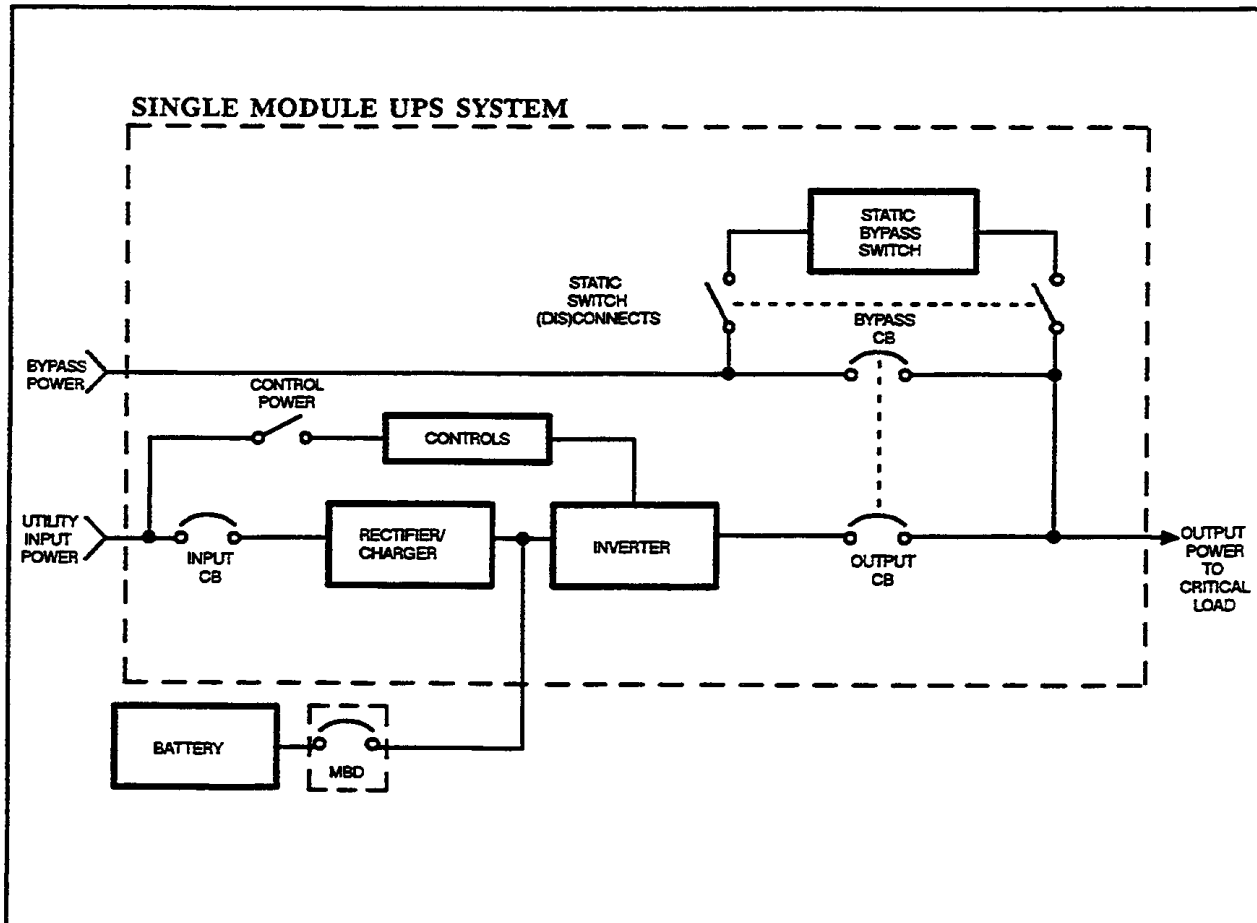

#### UPS Module

The UPS module consists of system controls, a rectifier/charger, an inverter, static bypass switch, load transfer control, protective devices, and other accessories.

**System Controls:** The system control logic automatically manages critical bus operation and monitors performance of the UPS module. Microprocessor technology and dedicated firmware provide advanced logic control and a comprehensive display of information. The system includes ports for communicating with external devices.

**Rectifier/Charger:** The rectifier/charger converts utility power from AC to DC to charge the battery and provide the DC input to the inverter. Its design limits reflected harmonic current distortion to source power and provides low ripple DC power for charging batteries.

**Inverter:** The inverter converts DC power into the precise AC power required to supply a sensitive critical load. The inverter converts DC power into a pulse-width-modulated (PWM)/six-step waveform that is easily filtered into a clean sine wave output. The PWM/stepwave also minimizes the harmonic voltage distortion caused by typical switching power supplies and other non-linear load components used in computers and related electronics.

---

**Static Bypass Switch:** The static (solid-state) bypass switch immediately transfers the load from the inverter to the bypass AC power source in the event of a severe overload on the system or a failure within the UPS. This transfer takes place without any interruption of the power supplied to the load. The system includes redundant circuits to detect and isolate shorted SCRs in the static switch.

Fuses are installed in series with the static bypass circuit to ensure reliable overload protection in the unlikely event of a catastrophic output condition (for example, a dropped wrench) electrically close to the output of your UPS system. The static switch SCRs themselves are rated to easily handle the fuse-blowing current.

**Bypass Circuit:** The bypass circuit consists of a motor operated circuit breaker in parallel with a solid state (static) switch and associated synchronizing and control circuitry to transfer the load to/from the bypass source.

### **Battery Plant**

The battery is used as the alternate source of power to supply DC power to the inverter if the AC supply voltage is outside the acceptable range. The battery supplies power to the inverter until the utility power is restored or until an alternate power source is available. If AC source power is not restored or an alternate power source is not available, the battery can be sized to provide power long enough for an orderly shutdown of the load.

---

## 2.2 Detailed Component Descriptions

### 2.2.1 Controls

#### Hardware

The Series 600 UPS Operator Interface Display System is designed to provide all of the information that is required for the operation of the Series 600 UPS, in an eye-level front panel location. The following is a list of the hardware features:

1. The system is designed for automatic operation with minimal operator interface. System controls are simple and easy-to-use.
2. The Series 600 UPS is equipped with an easy-to-read back-lighted 640 x 200 pixel liquid crystal display (LCD) screen. It presents system information in a way that is easy to understand.
3. The display system is controlled by a dedicated microprocessor with a non-volatile (EPROM) program and a battery-backed event memory.
4. The Series 600 has communication ports (terminal board connections) for:
  - a. Transmission of present status information to remote terminals via a resident auto-dial communications program and an external modem. This port also responds to inquiries of the UPS system status and history from the remote terminal.
  - b. Reporting UPS system status and history information in response to inquiries from a local terminal (no modem required).
  - c. Reporting to a local monitor the information requested from the local terminal.
  - d. Reporting information to a Liebert SiteScan or Sitemaster central monitoring system.
  - e. Relaying selected alarm messages to a Liebert Remote Monitor Panel and to contacts for customer use.



#### NOTE

*All external communication devices are optional equipment.*

#### Firmware

The Operator Interface Display System firmware enables the operator to monitor the UPS system status, to control the power flow through the UPS, to monitor all of the meter readings, to execute the start-up, shutdown, and the load transfer procedures, to access the event history files and to make adjustments to the programmable parameters. The following is a list of the firmware features:

1. The menu-driven firmware prompts the operator for input.
2. Step-by-step instructions assist the operator during the start-up, shutdown, and the load transfer procedures. This helps to eliminate operator errors.
3. Diagrams illustrate circuit breaker status and the power flow through the UPS system.
4. The Present Status screen reports information about the system's present status. The History Status screen chronicles the events leading up to and immediately after a fault. The Event History screen lists all of the alarm messages that have been logged over a period of time.

Refer to **3.0 - Operation** for a description of the controls and indicators located on the Operator Control Panel.

---

## 2.2.2 Rectifier/Charger

The rectifier/charger consists of an input circuit breaker, isolation transformer (optional on 150 to 375 kVA models), AC current limiting circuit, battery equalize charge circuit, DC filter, battery charge current limiting circuit, and bridge rectifiers.

### Operation

The rectifier/charger converts the AC input power to DC power. This conversion is accomplished by 3-phase bridge rectifiers using SCRs. All phases are individually fused. One bridge is connected to each secondary winding of the input isolation transformer. For 338 to 1000 kVA SCR-based modules, reflected input current THD is less than 9% at full load (which may be reduced to less than 4% with optional filter). For 150 to 375 kVA modules, reflected input current THD is less than 30% at full load (which may be reduced to less than 7% with optional filter).

The filtered output of the rectifier/charger provides regulated DC power to drive the inverter and charge the battery.

### Input Circuit Breaker

The input circuit breaker is sized to allow enough current to recharge the battery and supply a full rated load at the same time. The circuit breaker contains a thermal magnetic trip mechanism and an undervoltage release that interrupts power, preventing damage to the system, if there is an internal AC over-current condition or a short circuit. This circuit breaker must be closed manually.

### Isolation Transformer

The input isolation transformer has a dry type core, and copper windings with class H insulation. The transformer on 338 to 1000 kVA SCR-based modules has a delta primary, with delta and wye secondary windings. The optional rectifier input transformer on 150 to 375 kVA modules has a delta primary and a single delta secondary winding. The isolation transformer provides the initial step of critical bus isolation. This reduces the AC shock hazard at the battery and at other DC components, and prevents a DC fault from disrupting upstream AC circuitry.

The transformer has a nominal tap and one tap 6% below the rated nominal input voltage (normally used for 460 VAC input).

### Input Current Limit

AC input current sensing transformers (CTs) are used to measure current levels on the primary side of the isolation transformer. Control circuitry connected to the CTs restricts the AC current to less than 125% of the full input current rating by reducing the battery charging voltage. This current limit is adjustable from 100 to 125% and is factory set at 115%. A second level of input current limit is initiated by an external contact closure (field supplied for use with back-up generator), and is adjustable from 85 to 125% (factory set at 100%).

After an outage, the current slowly ramps up (walks-in) from 20% of the rated input current to 100% over a 15 to 21 second period. The maximum rate of change of the AC input current is 15% per second. The input current walk-in reduces the start-up surge distortion effects on all other equipment connected to the same source and prolongs the service life of internal components.

### Input Current Inrush

The maximum sub-cycle of inrush current due to the input power transformer is less than 800% of the rated input current for the first 1/2 cycle. The optional input filter limits inrush current to less than 450%.

### Input Power Factor

The rated input power factor is no less than 0.81 lagging at the nominal input voltage and the full rated UPS load. The optional input filter will improve the power factor to better than 0.91 lagging at full load. Refer to drawings for your specific model.

---

### 2.2.3 Battery Charging Circuit

The CHARGING circuit is capable of recharging the battery plant to 96% of full capacity within 10 times the discharge time. Recharging the last 5% takes longer because of characteristics inherent in the battery. DC ripple voltage and current are limited to less than 2% RMS to preserve battery life during long-term float charging while the UPS system is operating on utility source power.

#### Operation After Discharge

When commercial power is interrupted, the battery continues to supply DC power to the inverter without interruption to the critical load. If the AC source power is restored before the battery has fully discharged, the rectifier automatically restarts and resumes carrying the inverter and battery recharge load requirements.

#### Operation After End-of-Discharge

The battery time screen displayed on the control panel enables you to estimate when battery shutdown will occur. You will have enough time to energize an alternate AC power source or to initiate an orderly shutdown of the critical load. If the battery plant discharges to the shutdown point during an outage, the UPS automatically disconnects the load, the AC input, and the battery. After AC input power is restored, the rectifier can be manually restarted by the user.

#### Battery Disconnect

The module battery disconnect (MBD) circuit breaker is used to isolate the UPS module from the battery during maintenance and to automatically disconnect the battery from the inverter at the end of battery discharge. The MBD circuit breaker can be opened or tripped automatically, from the control panel, or manually. It must be closed manually.

#### Battery Charge Current Limiting

The battery recharge current, after a battery discharge, is limited to between 1 and 25% (adjustable) of the full load discharge current. An external dry contact closure (field supplied) activates a reduced second level of the battery charge current limiting circuit for use with a back-up generator. These two levels of control regulate the amount of current that flows from the power source to the battery while the battery is recharging.

The battery charge current limit is factory set at 10% for normal operation and at 1% for alternate power source recharge operation.

#### Battery Equalize Charge Circuit

The battery equalize charge feature can be manually initiated or it can be programmed to operate automatically. Either can be selected from the battery equalize screen displayed on the control panel.

The battery equalizing charge circuit increases the rectifier/charger output voltage to charge the battery any time there is a power outage of 30 seconds or longer. The equalizing voltage is slightly higher than the float voltage. This decreases the time required to recharge the battery.



#### NOTE

*Equalize charging of sealed-cell batteries is not recommended.*

*Consult the battery manufacturer's manual for specific information about equalize charging.*

---

## 2.2.4 Inverter

The inverter is a solid state device that converts the DC output of the rectifier/charger or the battery to AC power.

### Operation

The inverter converts DC power—from either the battery or the rectifier/charger—into three pulse-width-modulated/six-step waveforms. These waveforms are filtered into low-distortion sine wave power. The inverter is controlled by an Application-Specific Integrated Circuit (ASIC). This integrated circuit controls the precise synchronization, amplitude, and frequency of the output voltage.

In addition to the inverter efficiently supplying a regulated AC output from a DC source, the output isolation transformer acts as a second stage of isolation between the critical load bus and the commercial source power. The inverter is configured to handle most critical load inrush surges. It maintains output voltage Total Harmonic Distortion (THD) within specifications even when handling non-linear computer loads. Refer to non-linear load characteristics.

### Output Regulation and Overload Performance

The inverter is capable of sustaining full output voltage  $\pm 2\%$  of the nominal voltage) for up to 150% overload at the output for as long as 30 seconds without reducing the output voltage. It can also handle at least 125% of the rated current for up to 10 minutes and 104% of the rated current continuously. If an overload condition is sustained (beyond inverter capacity) and a bypass source is available, the critical load is transferred to the bypass source and the inverter is disconnected from the load. Refer to **3.4 - Automatic Operations**.

### Non-Linear Load Characteristics

Computers and computer equipment with switching power supplies generate non-linear currents rich in fifth and seventh harmonics.

The inverter pulse-width-modulated/six-step waveform, coupled with the output filter, provides a natural path for reducing the fifth and seventh harmonic currents produced by the load. The inverter/filter limits the output voltage THD to less than 5% with up to 100% typical electronic data processing (EDP) loads. EDP equipment characteristically includes both non-linear and linear load components.

### Unbalanced Load Characteristics

Unbalanced loads are actively regulated. The phase-to-phase voltage balance is maintained to within 2%, even with a 50% load imbalance.

Each phase-to-phase voltage is regulated on the primary side of the output isolation transformer, which in turn provides individual phase-to-neutral regulation on the secondary side (sensing is phase-to-neutral on the secondary side). The output isolation transformer has an open delta primary and a zigzag wye secondary configuration. The range of control of the phase-to-neutral voltage is within  $\pm 2\%$ .

The three-phase, root mean square (RMS—approximately 70% of the peak) average voltage is also regulated through a separate control circuit (phase-to-phase sensing).

---

## 2.2.5 Static Bypass

A static bypass is an integral part of the UPS. The static bypass consists of a static bypass switch and bypass power switching devices (motor operated circuit breakers). An automatic transfer control circuit senses the status of the operator controls, UPS logic signals and alarm messages, and critical bus operating conditions. If the inverter output can no longer supply the critical load, the static bypass switch (in conjunction with motorized circuit breakers) automatically transfers the critical load to the bypass source without interruption.

### Fuse Protection

The static bypass switch path uses two back-to-back SCRs per phase. Each phase is individually protected by a fuse sized to clear only in the event of a catastrophic fault. This is a more reliable method than depending on external protection devices. The fuses are in the circuit to protect the critical bus distribution equipment against catastrophic faults. The static switch SCRs are oversized to easily handle any current surges that may blow the fuses.

### Shorted SCR Monitoring

The static bypass system has redundant shorted SCR sensing circuits and disconnects. This will prevent UPS output power backfeed to the distribution system even if two component failures exist simultaneously. If a shorted SCR is detected, the static bypass switch is isolated and annunciated at the SCC control panel, and the critical load remains on UPS output power.

### Static Switch Isolation

The motor operated bypass circuit breaker, wired in parallel with the static switch, automatically closes within 200 milliseconds after the load is transferred to the bypass power source, removing the static switch from the power flow.

Also, if required for maintenance, the static switch can be isolated from the bypass line by opening (to the OFF position) the Static Switch Disconnects.

### Pulsed Parallel Operation

When an overload condition such as magnetic inrush current or a branch load circuit fault exceeds 155%-180% of the full load current rating, the static bypass switch pulses on for 40 milliseconds. This allows up to 1000% rated full load current from the bypass line to clear the overload without closing the bypass circuit breaker (a Liebert design exclusive). The bypass source is in parallel with the UPS system, permitting the bypass source to carry the initial overload current. If the overload clears before 40 milliseconds, a load transfer to bypass is not made. If the overload condition exceeds the inverter capacity, the automatic transfer is made (maintaining the load voltage within the specified limits).

This pulsed static switch operation reduces nuisance operation of motor-operated circuit breakers for short-term conditions.

### Load Transfers

Transfers to (transfer) or from (retransfer) the bypass may be performed automatically or manually in a make-before-break (MBB) sequence. This is accomplished through the overlapping operation of the inverter output and the bypass power switching devices.

Manual load transfers and retransfers are initiated by the operator from the UPS control panel.

In a manual operation, or an automatic retransfer, the two motorized circuit breakers (output and bypass) are both closed simultaneously for a short period of time (overlap).

Automatic transfers are initiated by the system control logic when an overload is beyond the capacity of the UPS inverter or when a fault occurs within the UPS module. An automatic retransfer is initiated if this function is enabled and if system conditions for a retransfer are present.

In an automatic transfer, the circuit breakers do not overlap, but during the short time gap bypass power is supplied to the critical load through the solid state static switch.



---

## Transfer and Retransfer Conditions

### 1. Automatic Transfers to Bypass

Critical bus conditions that will initiate an automatic transfer of the critical load from the UPS inverter output to the bypass source are:

- a. Output Overload: overcurrent condition in excess of the current versus time overload capacity curve.
- b. Over/Under Voltage (OV/UV): critical bus voltage is outside the allowable tolerance.
- c. Inverter Inoperative: inverter diagnostic circuitry senses an imminent inverter output OV/UV condition.
  1. Battery discharged to the shutdown voltage.
  2. Inverter or rectifier fault condition (power, logic, or over-temperature) present or imminent.
  3. Emergency Power Off (EPO) or Emergency Module Off (EMO) circuit activated.
  4. Failure of system logic or logic power.

### 2. Manual Transfers

Manual transfers may be initiated at any time provided no transfer inhibition conditions are present.

### 3. Transfer Prohibited

A manual transfer to the bypass source shall be inhibited if any of the following conditions exist:

- a. Bypass frequency exceeds  $\pm 0.5$  Hz of the nominal.
- b. Inverter to bypass voltage difference ( $\Delta V$ ) exceeds a predetermined percentage (normally 5%).
- c. Static switch disconnect (a manual switch) open.
- d. OK to Transfer signal from the control logic is not present.



#### NOTE

*A load transfer to the bypass line will be completed whenever an automatic transfer to bypass is initiated. If the Static Switch Unable alarm message is present for any reason (including a  $\pm 2\%$  phase lock synchronization error), the automatic transfer will be interrupted for 40 to 120 milliseconds. Because of the reliability of the UPS components, an interrupted load transfer is a very unlikely occurrence.*

### 4. Automatic Retransfers to UPS

Critical bus conditions that must be present to initiate an automatic retransfer (Auto-Rexfer) of the critical load from the bypass source to the UPS inverter output are:

- a. The number of Auto-Rexfer Attempts selected must be greater than zero (0). If zero (0) is selected, no automatic retransfers will occur.
- b. Critical load was initially transferred to the bypass source due to an output overload only.
- c. Overload has since dropped below 100% of the rated load.
- d. Both the Input and Battery (MBD) circuit breakers have remained closed since the overload transfer.
- e. OK to Transfer signal received from the control logic for at least 10 seconds, within 5 minutes of the overload transfer. (A manually initiated retransfer from bypass is required for overloads lasting 5 minutes or more.)
- f. Cyclic-type overloads, which occur up to five (select range is 0 to 5) times in 60 minutes, are automatically returned to the inverter for each event including the Nth overload. A manually initiated retransfer from bypass is required for the N+1 overload.

### 5. Manual Retransfers

Manual retransfers may be initiated at any time provided no retransfer inhibition conditions are present.

---

## 6. Retransfer Inhibited

A retransfer (automatic or manual) from the bypass source to the UPS inverter output shall be inhibited if any of the following conditions exist:

- a. Manual (and Automatic) Retransfer Inhibitions:
  1. Bypass frequency exceeds  $\pm 0.5$  Hz of the nominal.
  2. Inverter-to-bypass voltage difference ( $\Delta V$ ) exceeds a predetermined percentage (normally 5%).
  3. Bypass circuit breaker is inoperative.
  4. OK to Transfer signal from the control logic is not present.
  5. Inverter or rectifier fault.
- b. Automatic Retransfer Inhibitions (in addition to those above):
  1. The load transfer to bypass was not caused by an output overload.
  2. Excessive cyclical overloads within a one-hour period.
  3. Retransfer conditions are not satisfied within 5 minutes of the initial transfer.

---

## 3.0 OPERATION

---

### 3.1 Display Screen and Operator Controls

The Liebert Series 600 UPS system is equipped with a microprocessor-based Operator Control Panel and Display Screen designed for convenient and reliable operation. This section of the UPS was designed for personnel safety during maintenance and service activities as well as during normal user operations.

The front location of the control panel (**Figure 7** and **Figure 8**) enables the user to quickly identify the current status of the UPS and to perform most of the manual operations. The operator display screen is driven by an easy-to-follow menu-prompted software program.

#### Features

The Series 600 interface display system enables the operator to easily perform the following:

- Obtain a quick indication of operational status:
  - Is the critical bus OK?
  - Is the UPS OK?
  - Is the battery available?
  - Is the bypass line available?
- Monitor the power flow through the UPS system and monitor all meter readings:
  - Is the critical load being supplied power from the UPS or bypass?
  - Are input, battery, and output voltage, frequency, and current readings at nominal levels?
  - How much battery time is still available during an outage?
  - Is the battery recharging after discharge?
- Execute operational procedures:
  - Perform critical bus transfer/retransfer between the UPS and the bypass line.
  - Start-up and shutdown the UPS.
  - Shutdown the system instantly in the event of an emergency.
- Access status reports and history files:
  - Obtain a complete listing of the present status of the UPS system (input, output, and battery voltage, frequency, and current readings, and any alarms that may be present).
  - Review a complete history report of all events leading up to and immediately after a fault condition.
  - Examine an archive listing of all alarm conditions that have occurred over a period of time.
- Make adjustments to programmable parameters (access limited by Security Access function):
  - Set the date and the time functions.
  - Change the auto-dial phone number and the modem options.
  - Select the number of auto-retransfer attempts.
- Make adjustment, if desired, to the UPS output voltage before performing a manual load transfer.

Figure 7 Operator Controls, 150 to 225 kVA (left) and 300 to 375 kVA (right)

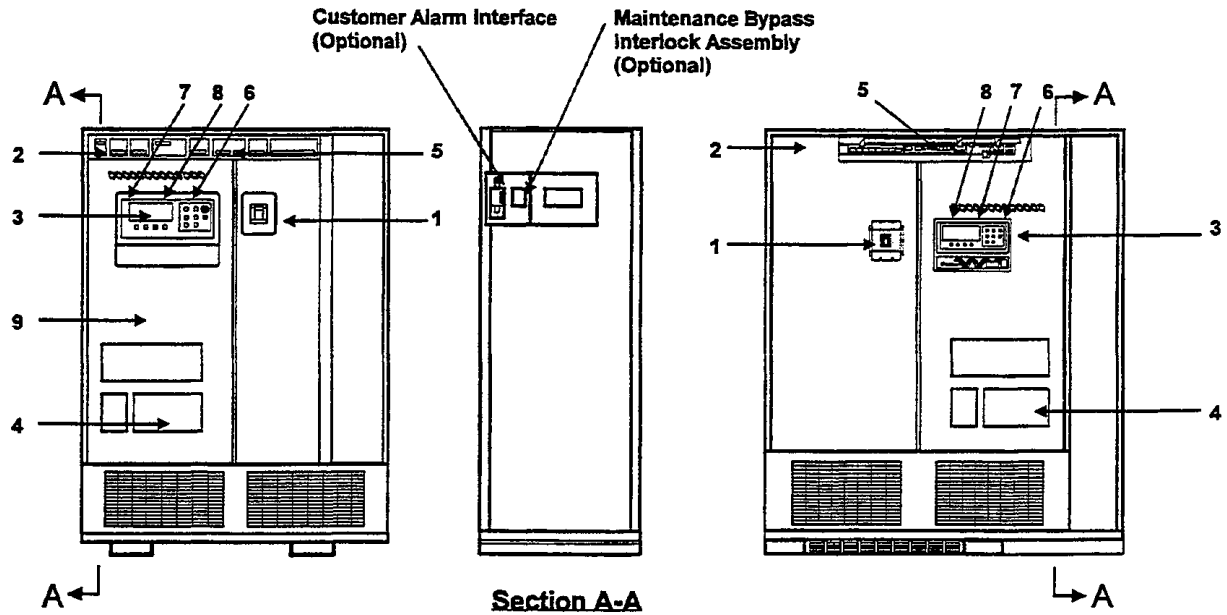

Item	Description	Function
1	Input Circuit Breaker	This manually operated circuit breaker provides power to the UPS rectifier.
2	Control Power Disconnect (behind control panel door)	This manually operated switch provides power to the controls. It is normally ON. Turn it OFF only for maintenance procedures.
3	Operator Control Panel	Refer to <b>Figure 10</b> for controls available on this panel.
4	“Close Bypass” Jumper (S2 on Logic Board, behind door)	Refer to <b>Figure 9</b> .
5	Bypass Reset Switch (SW1 on Transfer Relay board, behind door)	Refer to <b>Figure 9</b> .
6	Interlock Button (on rear of Control Panel)	Refer to <b>Figure 9</b> .
7	Bypass Circuit Breaker (behind control panel)	This motorized circuit breaker connects the critical load to the bypass line.
8	Output Circuit Breaker (behind control panel)	This motorized circuit breaker connects the critical load to the UPS inverter output.
9	Static Switch Disconnect (behind control panel, certain 480V models only)	This manually operated switch disconnects the static switch from the bypass line and from the critical load. It is normally ON (closed). Turn it OFF (open) only to isolate (disconnect) the static switch for maintenance procedures.

**Figure 8 Operator Controls, 338 to 1000 kVA (SCR-Based Products)**

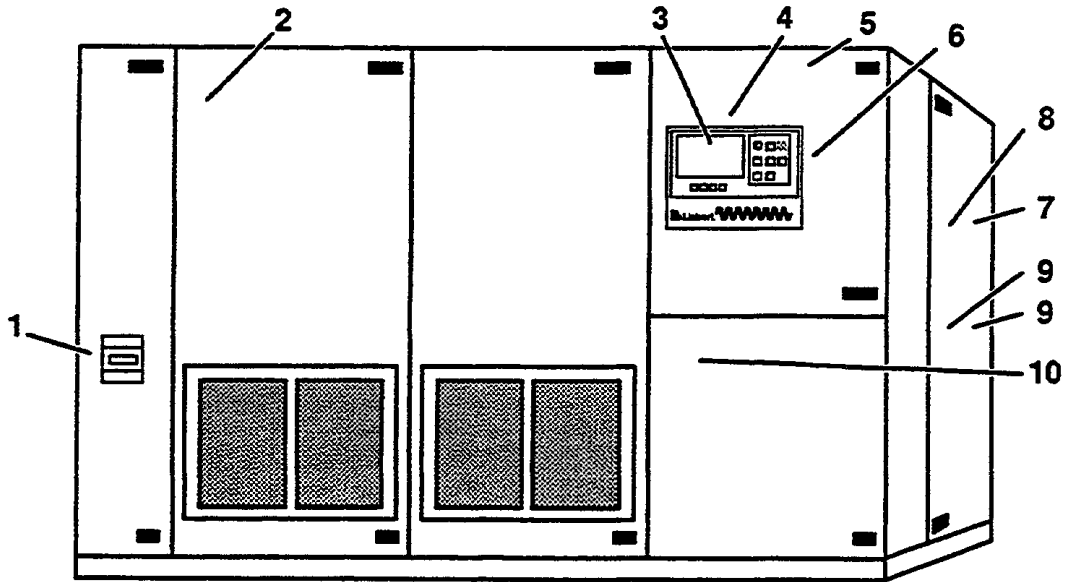

Item	Description	Function
1	Input Circuit Breaker	This manually operated circuit breaker provides power to the UPS rectifier.
2	Control Power Switch (behind door)	This manually operated switch provides power to the controls. It is normally ON. Turn it OFF only for maintenance procedures.
3	Operator Control Panel	Refer to <b>Figure 10</b> for controls available on this panel.
4	“Close Bypass” Jumper (behind door)	Refer to <b>Figure 9</b> .
5	Bypass Reset Switch (behind door)	Refer to <b>Figure 9</b> .
6	Interlock Button (on rear of Control Panel)	Refer to <b>Figure 9</b> .
7	Bypass Circuit Breaker (behind door)	This motorized circuit breaker connects the critical load to the bypass dine.
8	Output Circuit Breaker (behind door)	This motorized circuit breaker connects the critical load to the UPS inverter output.
9	Static Switch Disconnects (behind door)	These manually operated switches disconnect the static switch from the bypass dine and from the critical load. They are normally ON (closed). Turn them OFF (open) only to isolate (disconnect) the static switch for maintenance procedures.
10	Reset Switches (SW1) for Static Switch Monitors (behind door)	Refer to <b>Figure 9</b> .

Figure 9 Switches Behind Control Panel Door of 338-1000 kVA (SCR-Based Products)

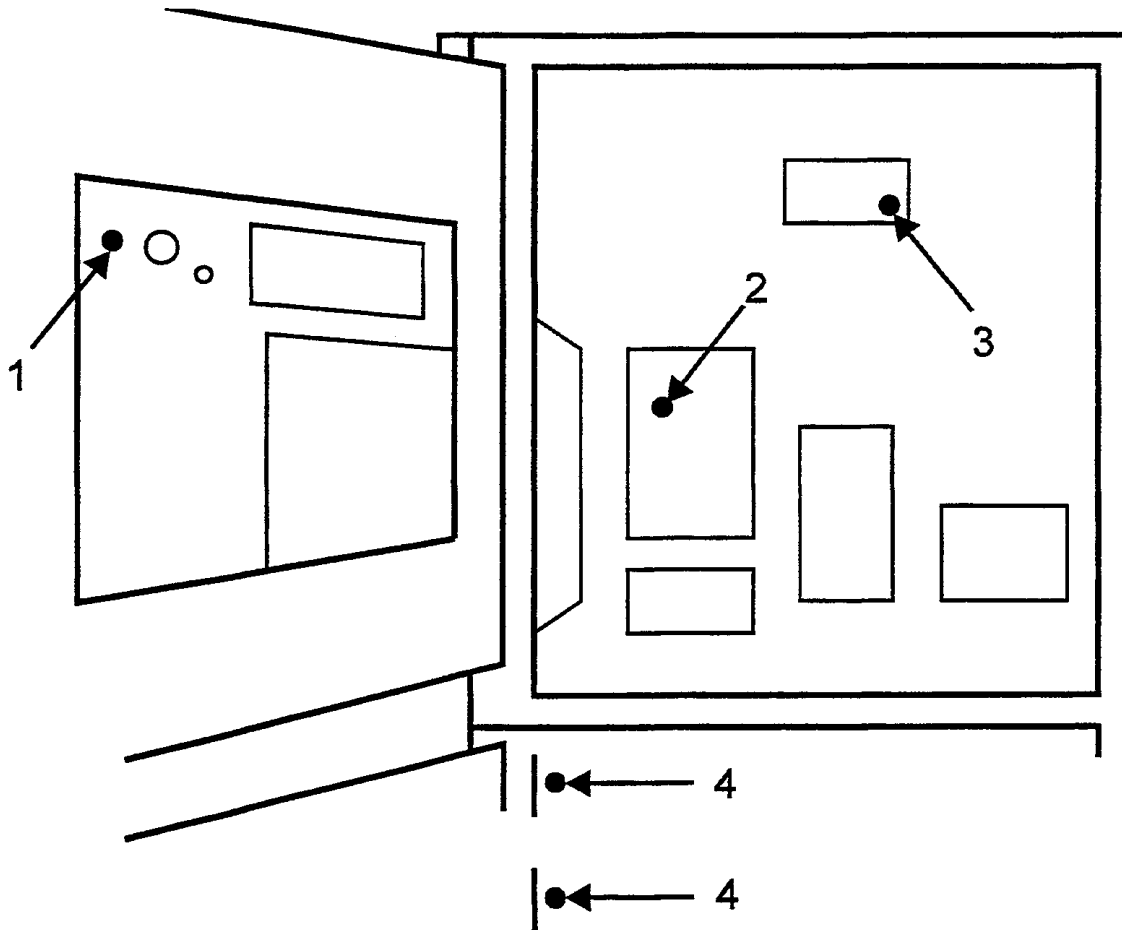

Item	Description	Function
1	Interlock Button (on rear of Control Panel)	Press this button to make authorized changes to any site parameter protected by the Security Access function. These include the time, date, auto-dial phone number, and other site parameters.
2	"Close Bypass" Jumper (S2, on Logic Board)	Remove and replace jumper to close the Bypass circuit breaker during a start-up procedure, if it remains open after a shutdown procedure (refer to <b>3.3.1 - Start-Up Procedures</b> ). Note that the Static Switch Disconnects must be OFF to reset the Bypass circuit breaker. See also Bypass Reset Switch (Item 3).
3	Bypass Reset Switch (SW1, on Transfer Relay Board)	Press this button to reset the transfer relays during start-up, after an Emergency Power Off shutdown. You must press this button before the Close B.P. Switch (Item 2).
4	Reset Switches (SW1) for Static Switch Monitors (behind door)	Press these two switches before closing Static Switch Disconnects when recovering from a shutdown that includes loss of Control Power. Green LED on means Control Power is available. Red LED on means Reset Switch needs to be pushed.

Figure 10 Series 600 UPS Operator Control Panel

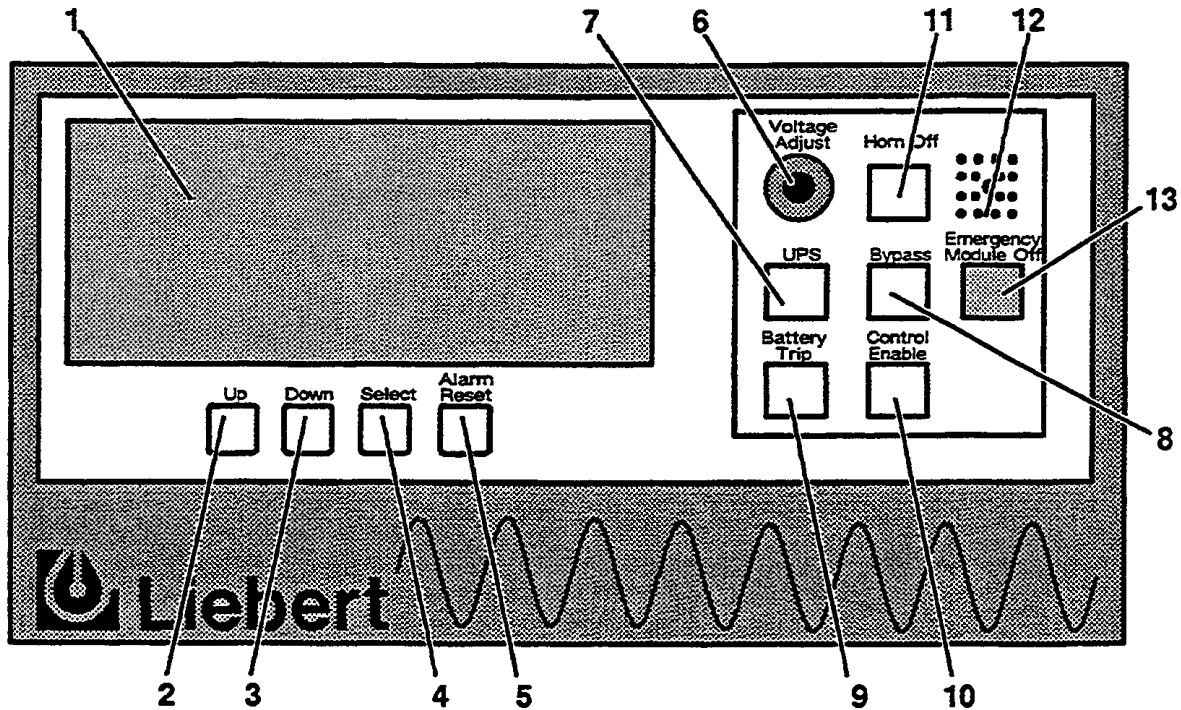

Item	Description	Function
1	Display Screen	This screen displays all vital UPS information in one convenient location. All of the UPS monitoring functions and conditions are indicated here.
2	Up	This touch-sensitive pad (button) is used to move the cursor up through various selections present on the display screen. Note that all pads on this control panel have touch-sensitive switches behind them.
3	Down	Similar to the Up pad, this pad is used to move the cursor down through the various selections present on the display screen.
4	Select	After choosing the desired item (with highlighted cursor) from the display screen with the Up and Down pads, pushing this pad tells the microprocessor to go to the highlighted selection.
5	Alarm Reset	This pad is used to clear all of the alarm conditions that are no longer present. However, all active alarms remain in memory and on the applicable screens until they are corrected. Note that this pad also resets the History Status Report memory buffer.
6	Voltage Adjust	This push-to-turn knob permits adjustment of the UPS output voltage to meet load requirements or to match the bypass voltage before transferring the load to or from bypass.
7	UPS	This pad activates the circuits that connect the UPS to the critical load (a retransfer). When this pad is pushed (along with Control Enable), the output circuit breaker closes and the bypass circuit breaker opens.
8	Bypass	This pad activates the circuits that connect the bypass line to the critical load (a transfer). When this button is pushed (along with Control Enable), the bypass circuit breaker closes and the UPS output breaker opens.
9	Battery Trip	This pad can be used (along with Control Enable) to trip the module battery disconnect (MBD) circuit breaker open (disconnecting the battery from the UPS).
10	Control Enable	This pad must be pressed simultaneously with the UPS, Bypass, or Battery Trip pads to activate them.
11	Horn Off	This pad is used to silence the alarm horn after it is activated. When this switch is pressed, the alarm horn is silenced but the active and latched alarm messages remain on the screen. The alarm messages still displayed stop Bashing to indicate they have been acknowledged.
12	Alarm Horn and Red LED	This electronic horn sounds to alert nearby personnel whenever a new alarm occurs. A red LED (light emitting diode) is located in the middle of the alarm horn.
13	Emergency Module Off	During an emergency, pressing this guarded switch will transfer the load to bypass and then shut down the UPS module. The load will remain on bypass power. (Compare this with the Emergency Power Off procedure that opens the bypass circuit breaker, removing all UPS power to the critical load. Refer to <b>3.3.3 - Shutdown Procedures</b> .)

Figure 11 Menu Tree

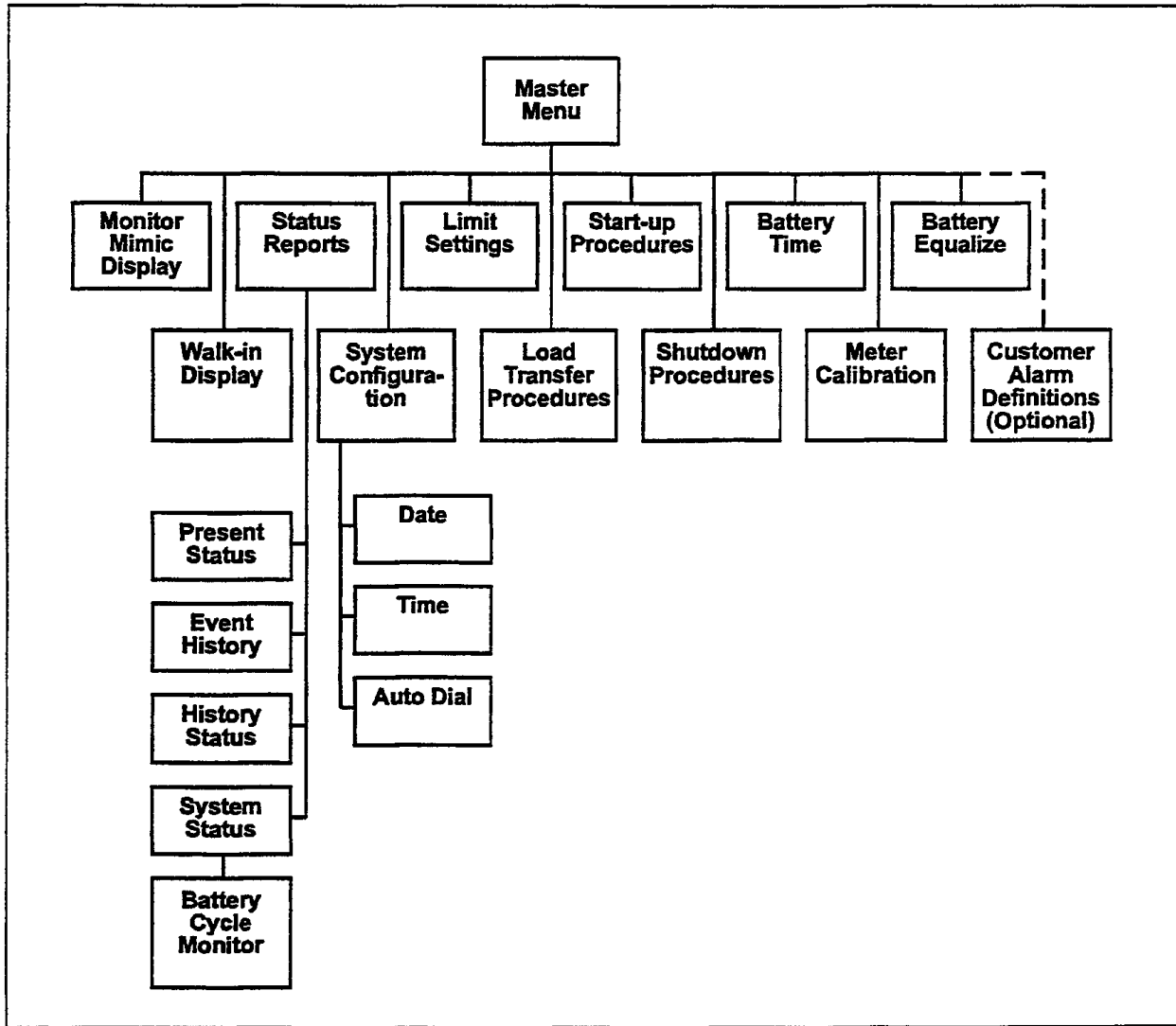

Figure 11 illustrates the primary screens that you can access through the Operator Interface Display System. The liquid crystal display (LCD) screen is back-lighted for easy readability. The following subsections describe what these screens display and how and when to use them.

System status information is available on the display screen and at local and remote terminals (provided power is available and **Control Power** is ON), even when the UPS module is not operating.

If the display screen is blank, either power is not available, the Rectifier Input (RIB) circuit breaker (external to the UPS) is open, or the **Control Power** switch is OFF. If these two devices are both closed (with power available) and the display is blank, contact Liebert Customer Service and Support. Note that system status information may be available at local and remote terminals. Use control touch pads to manually transfer load to the bypass line if display goes blank while load is on UPS (a very unlikely event).



### 3.1.1 Master Menu Screen

The Master Menu contains eleven primary menu selections that monitor and control the operation of the UPS.

Figure 12 Master Menu Screen

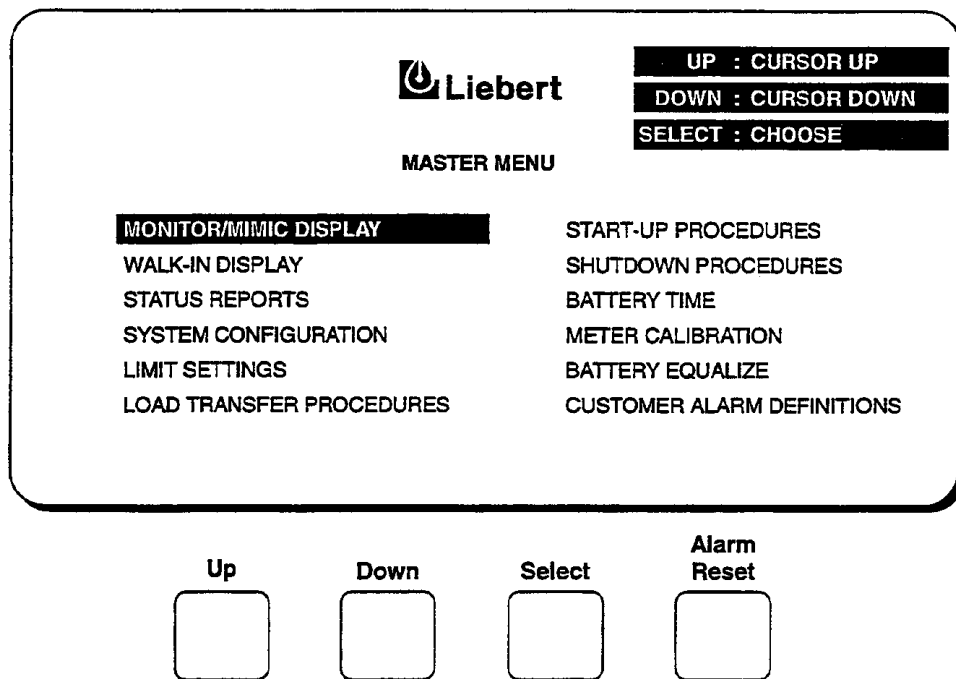

From any primary screen (accessed directly from the Master Menu), pushing the Select pad once will return you to the Master Menu. From any secondary screen, pushing the Select pad twice will return you to the Master Menu.

1. **MONITOR / MIMIC DISPLAY.**

This graphic mimics the power flow through the UPS. Input voltage and current readings, battery status, UPS ratings, load readings, circuit breaker indications, system status, and alarm messages are all displayed on this screen.

2. **WALK-IN DISPLAY.**

This is a bar-graph that shows DC bus voltage, input currents, and UPS output voltage (all in percent of nominal).

3. **STATUS REPORTS.**

This display consists of four sub-menu selections: Present Status, History Status, Event History, and System Status. These screens display data on the system's present and past performance. They also display information about any faults that have occurred in the system. Total operating hours (for controls) are displayed, and LCD back-lighting can be turned on or off.

4. **SYSTEM CONFIGURATION.**

This screen displays the current configuration of the UPS system. It also enables the operator to reset the date, time, and dial-out phone numbers. The operator can new, but can not change, any of the settings unless the Interlock (Security Access) button is pressed.

5. **LIMIT SETTINGS.**

This security access display shows the present UPS system alarm limit settings. The operator can view the settings, but they should not be changed without consulting Liebert Customer Service and Support.

---

## 6. LOAD TRANSFER PROCEDURES.

This screen specifies all of the steps required to manually transfer the critical load between the UPS and the bypass source. Comparisons of the voltage, frequency, and phase synchronization of the UPS output and the bypass line are also illustrated to aid in the transfer or retransfer procedure.

## 7. START-UP PROCEDURES.

This two-page screen lists step-by-step procedures to start the UPS.

## 8. SHUTDOWN PROCEDURES.

This two-page screen lists the proper sequence of steps to shutdown the UPS system for maintenance or repairs. The steps instruct the operator to transfer the critical load to bypass, open the battery circuit breaker and open the UPS input circuit breaker to shutdown and isolate the system. The critical load will remain on bypass power unless circuit breakers outside the UPS are also opened.

## 9. BATTERY TIME.

This graph displays the projected battery voltage drop caused by a battery discharge over time. During a period of battery discharge, the Series 600 calculates the battery time remaining based on battery rating, initial battery condition, and actual connected load. The UPS continues to update and display both rated (theoretical) and calculated time every 6 seconds. This enables the operator to immediately see the effects of load shedding on time remaining and to accurately assess his power resources.

## 10. METER CALIBRATION.

This security access screen enables an authorized Liebert field-service engineer to adjust and calibrate the UPS metered functions. The operator can view, but should not change, any of the settings.

## 11. BATTERY EQUALIZE.

The battery equalize screen lets the operator change the battery equalize recharging mode from manual to automatic, and to observe or change the equalize time. Battery equalize charge voltage is higher than battery float (constant) charge voltage.



### NOTE

*Equalize charging of sealed-cell batteries is not recommended.*

*Consult the battery manufacturer's manual for specific information about equalize charging.*

## 12. CUSTOMER ALARM DEFINITIONS.

This optional screen allows the operator to define alarms for conditions external to the UPS, battery, or switchgear.

### 3.1.2 Monitor/Mimic Display Screen

From Master Menu move the highlighted cursor to **MONITOR/MIMIC DISPLAY**. Press the Select pad and the Monitor/Mimic screen is displayed.

The Monitor/Mimic display screen is a simplified block diagram of the UPS system. This screen gives the operator an overall view of the power flow through the UPS system. The screen consists of three major sections: the input/UPS metering section, the load metering section, and the status and alarm message areas. The metered parameter values on the Monitor/Mimic screen are updated at one-second intervals.

Figure 13 Monitor/Mimic Display Screen

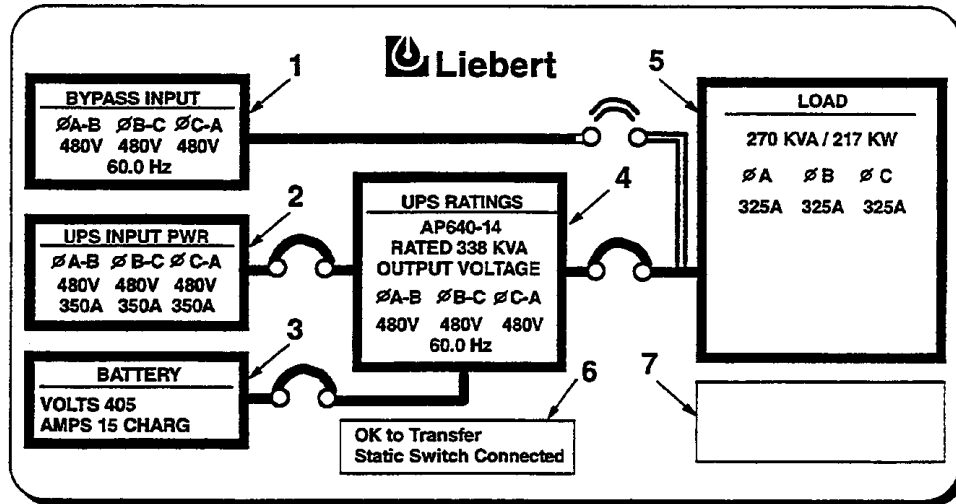

#### Input Metering Displays



#### NOTE

All voltage readings are phase-to-phase measurements (A-B, B-C, and C-A). All current readings are phase measurements (A, B, and C).

**Item 1 - Bypass Input.** This block displays the bypass input voltage and the bypass input frequency. The bypass circuit breaker is shown to the right of this block. The status of the circuit breaker is illustrated as open or closed.

**Item 2 - UPS Input Poor.** This block displays the UPS input voltage and current. The input circuit breaker is shown to the right of this block. The status of the circuit breaker is illustrated as open or closed.

**Item 3 - Battery Block.** The battery block displays the DC bus voltage and the charge or discharge current to or from the battery. This block reads **MODULE DC BUS** when the battery circuit breaker is open and **BATTERY** when the battery circuit breaker is closed during normal operation. This block reads **BATTERY EQUALIZE** when the battery equalize charge voltage is used to recharge the battery. The Module Battery Disconnect (MBD) is shown to the right of this block. The status of the circuit breaker is illustrated as open or closed.

#### Output Metering Displays

**Item 4 - UPS Ratings.** The module part number and kVA rating are specified at the top of this block. The UPS output voltage and frequency are also displayed in this block. The output circuit breaker is shown to the right of this block. The status of the circuit breaker is illustrated as open or closed.

**Item 5 - Load.** This block displays the total output power to the critical load in kVA and kW. The critical load current per phase is also displayed in this block. Note that kW is not displayed when the load is on the bypass line.

During an overload condition, the time remaining before transfer is displayed at the bottom of the load box.

---

## Status/Alarm Message Areas

The status/alarm message areas display vital information about the operation of the UPS system. During normal operation no alarm messages should be present. Changes in the status of the system and possible alarm conditions can be monitored. Both the status and the alarm messages are displayed in reverse video (highlighted—light on dark). The alarm messages continue flashing until the Horn Off pad is pressed. To clear a latching alarm, you must also press the Alarm Reset pad after the alarm condition is corrected.



### NOTE

*The Alarm Reset pad also resets the History Status Report memory buffer when it is held for 5 seconds.*

The following lists show the status and alarm messages that may be displayed in these areas. For more information and the corrective actions for these messages, refer to **Table 1** in this section.

### Item 6 - Status Messages Area

- Static Switch Connected
- Static Switch Disconnected
- Ok To Transfer
- Not Ok To Transfer

### Item 7 - Alarm Messages Area

- Input Fail
  
- DC Ground Fault
- DC Capacitor Fuse Blown
- Battery CB Open
- Battery Discharging
- Low Battery Warning
- Low Battery Shutdown
- DC Over-Voltage Shutdown
  
- Load On Bypass
- Auto Retransfer Primed
- Manual Reset/Retransfer
- Static Switch Unable
- Bypass Not Available
- Bypass Phase Sequence Wrong
  
- Control Power Fail
- Output Over/Under Frequency
- Output Under-Voltage
- Output Over-Voltage
- Overload
- Overload Transfer
- Overload Shutdown
- Reverse Power
- Rectifier Fuse Blown
- Inverter Fuse Blown
- Hardware Shutdown
- Emergency Off
- Battery Cycle Buffer Warning
  
- Ambient Over-Temperature
- Blower Failed
- Equipment Over-Temperature
- Over-Temperature Timeout

Figure 14 through Figure 17 illustrate how the Monitor/Mimic Display screen depicts the power flow through the UPS.

Figure 14 Monitor/Mimic Display Screen Example: Normal Power Flow

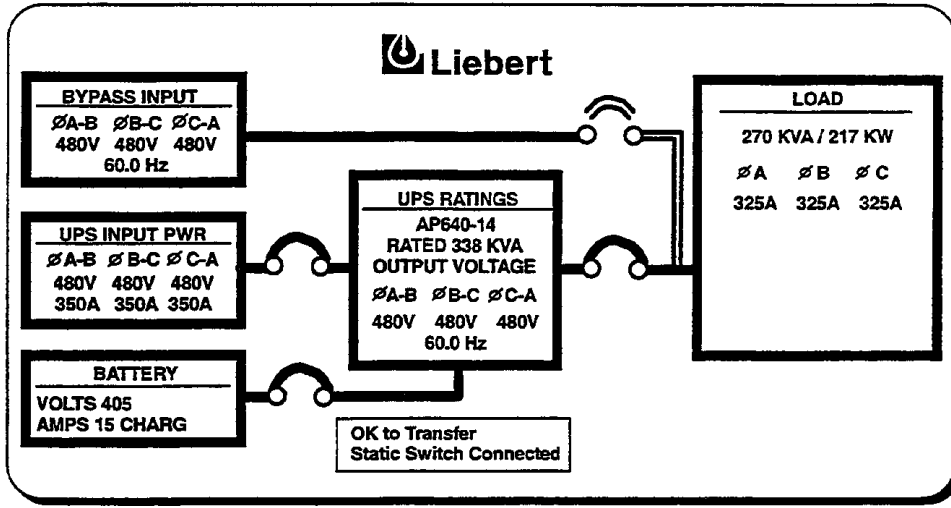

Figure 15 Monitor/Mimic Display Screen Example: Utility Fail

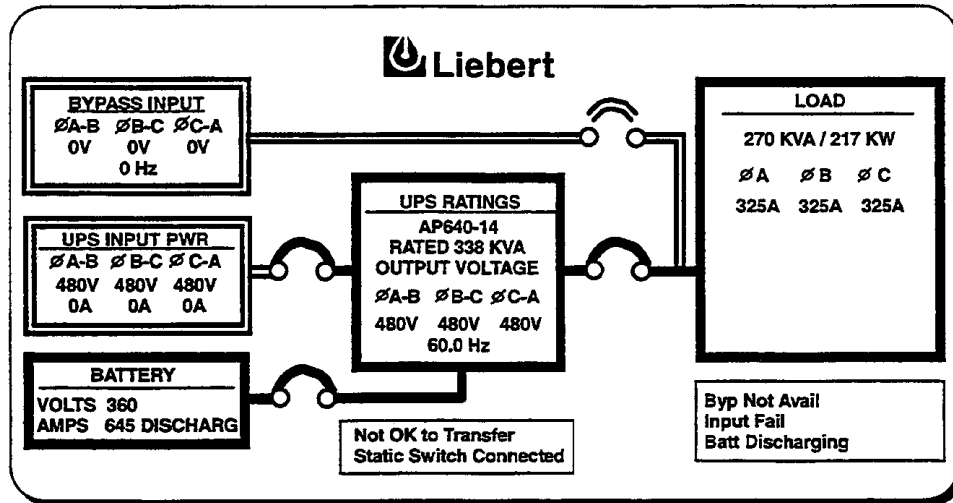

Figure 16 Monitor/Mimic Display Screen Example: Load On Bypass, UPS Module On and Charging Battery

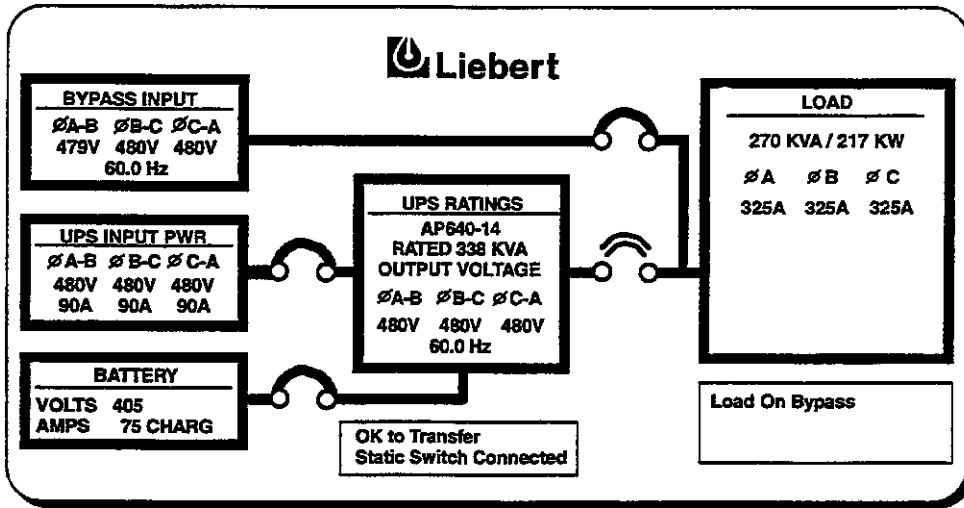
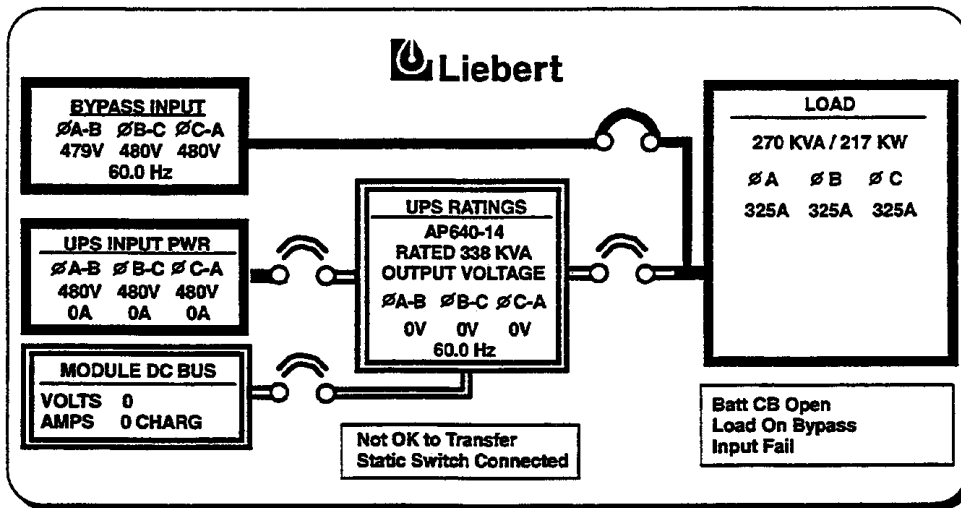
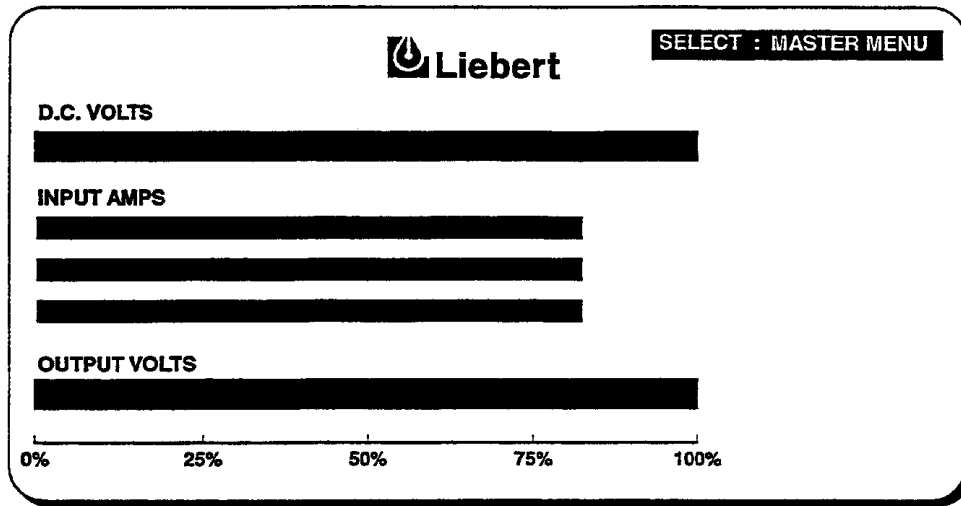

Figure 17 Monitor/Mimic Display Screen Example: Load On Bypass, UPS Module Off



### 3.1.3 Walk-In Display Screen

Figure 18 Walk-In Display Screen During Start-Up



From the Master Menu, highlight **WALK-IN DISPLAY** and then press the **Select** pad.

The Walk-In Display screen enables the operator to monitor the DC bus voltage, the input currents, and the UPS output voltage. This is important during the start up procedures.

During start up, the UPS input circuit breaker is closed and power is applied to the UPS module. The Walk-In Display screen graphically shows the voltage increasing on the DC bus as the UPS rectifier begins to walk-in.

The **DC Volts** bar gradually moves to the right. After the **DC Volts** bar reaches the 90% level, the UPS inverter starts-up and the **Output Volts** bar also moves to the right. Both the **DC Volts** and the **Output Volts** bars should settle near the 100% line as the UPS system becomes fully energized.

The three **Input Amps** bars (one for each phase of input current) move to the right during the initial transformer inrush. They should return to the left after the momentary inrush has subsided, then increase to about 10% as the **DC Volts** increases.

Modules equipped with the optional input filter will indicate more than 10% with no connected load.



#### NOTE

*After the critical load is transferred from the bypass line to the UPS, the Input Amps bars continue to indicate the percent of the design input current to the UPS rectifier.*

*If any Input Amps bar differs from the average bar length by more than 10%, call Liebert Customer Service and Support.*

### 3.1.4 Status Reports Screens

Go to the Master Menu and move the highlighted cursor to **STATUS REPORTS**. Press the **Select** button and the Status Reports screen is displayed.

The Status Report screen is divided into four sub-menu reports: **PRESENT STATUS**, **EVENT HISTORY**, **HISTORY STATUS**, and **SYSTEM STATUS**.

To look at any of the reports, do the following:

- a. From the Status Reports screen, press the **Up** or **Down** pad to move the highlighted cursor to the desired selection.
- b. Press the **Select** pad to view the desired report page.
- c. Use the **Up** and **Down** pads to move through a report that includes several screens (frames).
- d. Press the **Select** pad to exist the report.
- e. To return to the Master Menu, return to **EXIT** and press the **Select** pad.

Each report screen includes the date, time, and a frame number. The frame number indicates the relative sequence of a 4 millisecond time segment.

The System Status screen shows Total Operating Hours and also allows the user to turn LCD display back-lighting on or off.



#### NOTE

*Each of the four Status Reports can be displayed on a remote terminal.  
Refer to 3.1.14 - Communication Interfaces.*

Figure 19 Status Reports Screen

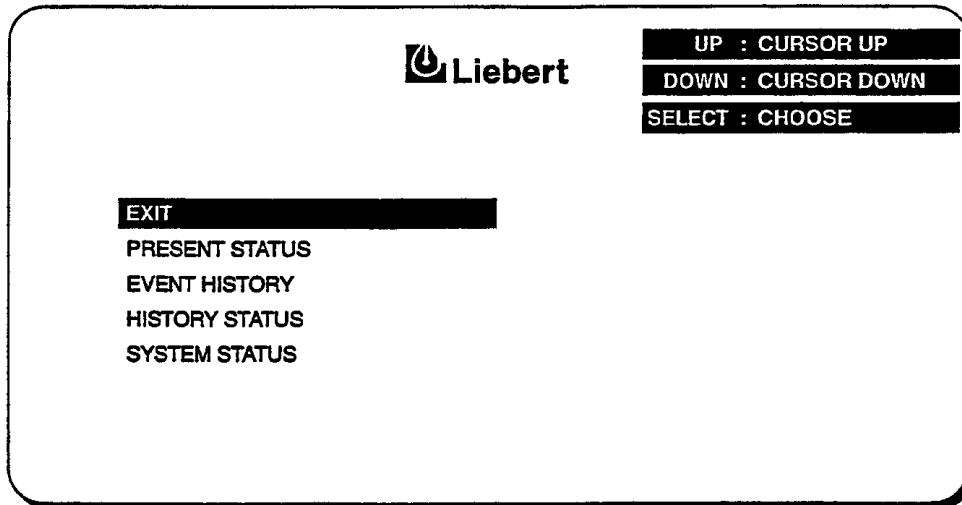



## Present Status

The Present Status screen shows the current status of the UPS module. This screen displays any alarm messages that are present, the UPS module output voltage and current for each phase, output frequency, the battery voltage and current, battery time remaining (during discharge events), input voltage and current for each phase, and the total output kVA.

Each update sequence (every 4 milliseconds) is called a frame. The frame number is displayed in the upper right corner. The Present Status screen display is updated every two seconds.

Battery Time Remaining (in minutes) is displayed on this screen during a battery discharge. The value is on the Battery Volts line in the TIME column (far right side of the screen). For the first two minutes of discharge, the Rated Time Remaining is displayed. After that, the Calculated Time Remaining is displayed, and updated every six seconds.

All the information on this screen, including Battery Time Remaining, is available to a local terminal or modem through the communications ports provided in the Series 600 UPS. Refer to **Table 3** in this manual for keyboard commands to use with the communication ports.

**Figure 20 Present Status Report Screen**

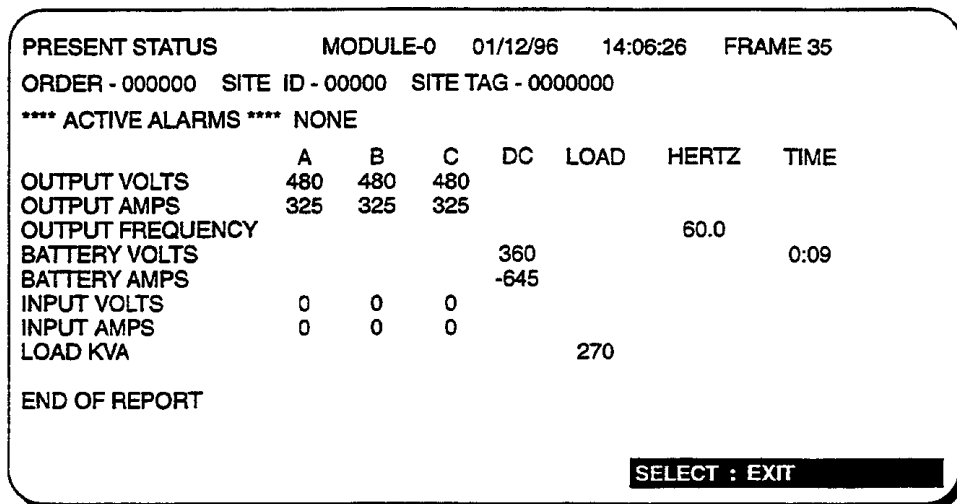

```
PRESENT STATUS      MODULE-0  01/12/96  14:06:26  FRAME 35
ORDER - 000000  SITE ID - 00000  SITE TAG - 0000000
**** ACTIVE ALARMS **** NONE
      A      B      C      DC      LOAD      HERTZ      TIME
OUTPUT VOLTS    480    480    480
OUTPUT AMPS     325    325    325
OUTPUT FREQUENCY                                60.0
BATTERY VOLTS                                     360          0:09
BATTERY AMPS                                       -645
INPUT VOLTS      0      0      0
INPUT AMPS       0      0      0
LOAD KVA                                270
END OF REPORT
SELECT : EXIT
```

The screenshot displays the 'PRESENT STATUS' screen for a UPS module. At the top, it shows 'MODULE-0', the date '01/12/96', the time '14:06:26', and 'FRAME 35'. Below this, it lists 'ORDER - 000000', 'SITE ID - 00000', and 'SITE TAG - 0000000'. A status line indicates '\*\*\*\* ACTIVE ALARMS \*\*\*\* NONE'. The main data is presented in a table with columns for A, B, C, DC, LOAD, HERTZ, and TIME. The table shows output voltages of 480V for all three phases, output currents of 325A, and an output frequency of 60.0 Hertz. Battery parameters show 360V and -645A. Input parameters are all 0. The load is 270 KVA. The screen ends with 'END OF REPORT' and a 'SELECT : EXIT' prompt.

---

## Event History

The Event History screen lists the active alarms present in the UPS system. This screen also displays the prior 128 alarm frames, in a first-in first-out (FIFO) sequence, that have taken place along with the date and the time that each alarm frame occurred. Use the **Up** and **Down** pads to look through the different alarm frames.

**Figure 21 Event History Report Screen**

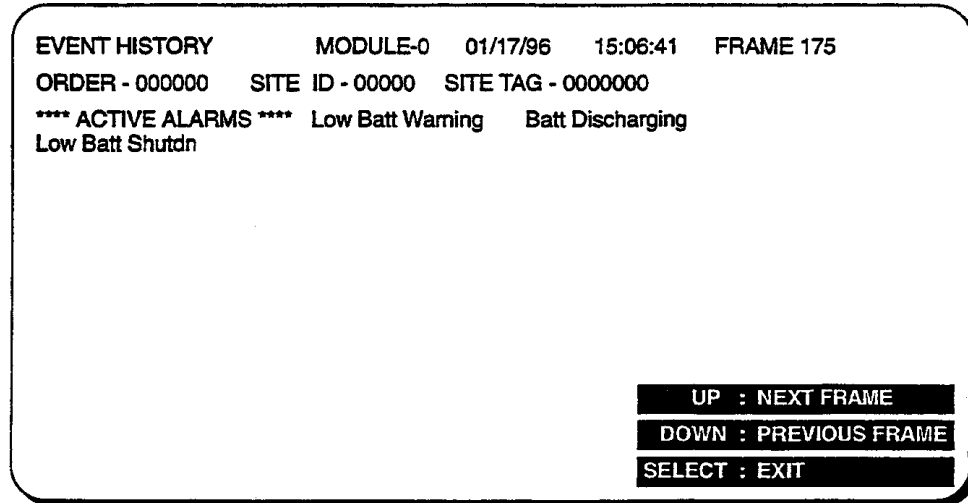

## History Status

The History Status screen displays 64 frames, of 4 milliseconds each, from the Present Status screen. Note that the values for output volts and amps are updated once each millisecond. Alarms are listed in the sequence they occurred, within 1 millisecond resolution. The frames are stored in a buffer (a computer information storage technique). The buffer stores the frames in a first-in first-out sequence. As a new frame enters the buffer the oldest one is released.

When a designated fault occurs (see list below), the buffer stores information for the next 24 frames and then freezes (stops gathering information). At that time, the History Status screen contains 40 frames before the fault, the frame when the fault occurred, and 23 frames after the fault. This 64-page report is a very useful diagnostic tool for the operator or Liebert Customer Service and Support. Use the **Up** and **Down** pads to view the screens.

**Figure 22 History Status Report Screen**

HISTORY STATUS		MODULE-0		01/17/96	11:21:59	FRAME 100	
ORDER - 000000	SITE ID - 00000		SITE TAG - 0000000				
**** ACTIVE ALARMS ****		Low Batt Warning		Batt Discharging			
Low Batt Shutdn							
	A	B	C	DC	LOAD	HERTZ	TIME
OUTPUT VOLTS	480	480	480				
OUTPUT AMPS	325	325	325				
OUTPUT FREQUENCY						60.0	
OUTPUT VOLTS	480	480	480				
OUTPUT AMPS	325	325	325				
BATTERY VOLTS				360			0:15
OUTPUT VOLTS	480	480	480				
OUTPUT AMPS	325	325	325				
BATTERY AMPS				-645			
INPUT VOLTS	0	0	0				
INPUT AMPS	0	0	0				
OUTPUT VOLTS	480	480	480				
OUTPUT AMPS	325	325	325				
LOAD KVA							

**UP : NEXT FRAME**

**DOWN : PREVIOUS FRAME**

**SELECT : EXIT**

The alarm conditions that cause the History Status buffer to stop gathering new data are:

- Auto Transfer to Bypass
- DC Cap Fuse Blown
- DC Over-Voltage Shutdown
- Inverter Fuse Blown
- Low Battery Shutdown
- Output Over-Voltage
- Output Under-Voltage
- Overload Shutdown
- Overload Transfer
- Over-Temperature Timeout
- Rectifier Fuse Blown
- Reverse Power

(For corrective action to these faults and a complete list of all of the alarm messages, refer to **Table 1** and **Table 2**.)



### NOTE

*The Emergency Off and Hardware Shutdown alarms will also freeze the History Status buffer with the Auto Transfer to Bypass alarm (if the load is on the UPS when the alarm condition occurs).*

The History Status buffer does not resume collecting new frames until the fault is cleared and the **Alarm Reset** pad is pressed for 5 seconds.

---

## System Status

The System Status screen displays the module Total Operating Hours, Enable Backlight, Language Selection, and the Battery Cycle Monitor.

### Battery Cycle Monitor

Selecting the Battery Cycle Monitor gives you access to detailed information about the system's most recent battery discharge events. Periodic review of this data can give a good indication of battery performance and expected life.

Each battery discharge cycle is put into one of four categories, depending on the length of the event:

- 0-30 Seconds Discharge
- 31-90 Seconds Discharge
- 91-240 Seconds Discharge
- Over 240 Seconds Discharge

Each discharge cycle is sorted by time duration and tagged with the following system parameters:

- System time and date
- Event Number
- Duration of cycle (seconds)
- Lowest DC Bus Voltage
- Highest DC Bus Current
- KW carried by the batteries at the start of cycle
- Battery Environment Ambient Temperature

Up to 132 discharge cycle events can be stored at any given time. When the buffer approaches its capacity, a warning message is broadcast via terminal and modem communication channels and a complete listing of all records (in order of occurrence) is sent to the terminal port. If a serial printer is attached to the terminal port, the operator can print a hard copy of the report. If a printer is not available, a terminal emulation program can capture the report to disk for later review or printing. Once the buffer is filled, new data will replace the old on a First In, First Out basis as new cycles occur.

To view this data, select the BATTERY CYCLE MONITOR option on the System Status screen. At the next screen (see **Figure 23**), you can select either the Battery Cycle Monitoring Summary screen or a screen showing detailed information on any one of the four categories of discharge (0-30 seconds, 31-90 seconds, 91-240 seconds and Over 240 seconds).

**Figure 23 Battery Cycle Monitor Screen**

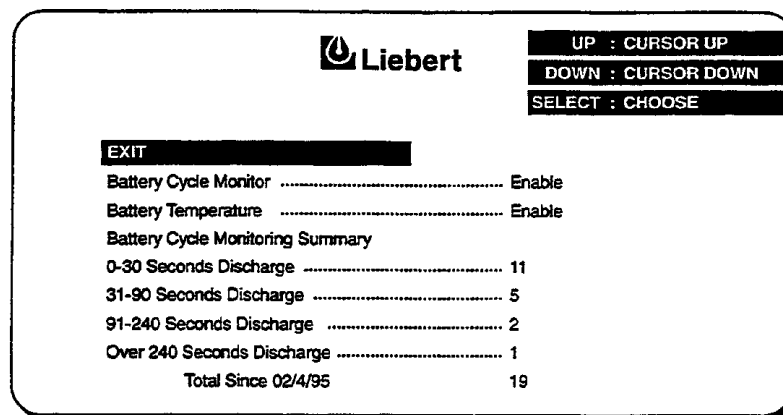

The Summary screen (**Figure 24**) shows Total Number of Discharge Cycles, Accumulated Battery Time, Accumulated Battery Amp Hours, Accumulated Battery Kilowatt Hours, and Battery Temperature. During a battery discharge event, the screen changes to show information about the present discharge cycle. The screen displays Active Cycle Time in place of Accumulated Battery Time, and shows Active Battery AH and Active Battery kWh instead of accumulated values.

**Figure 24 Battery Cycle Monitoring Summary Screen**

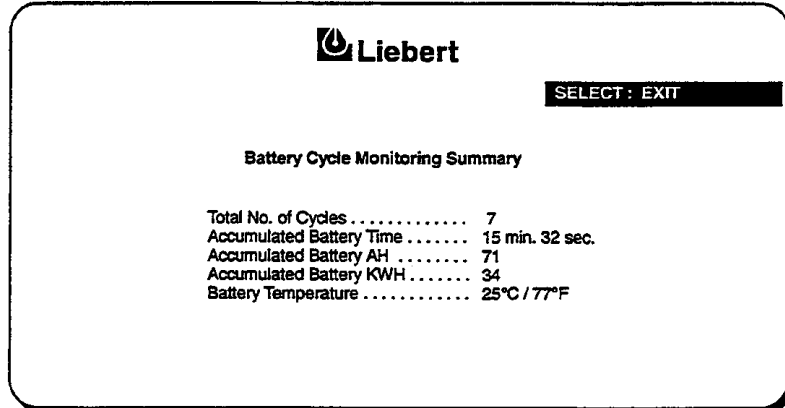

**Figure 25** shows a typical detail screen for the 91-240 Seconds Discharge category. This information can be collected remotely, through the optional communications board and modem, by a remote terminal or a personal computer equipped with a modem and communications program. See 3.1.14 - **Communication Interfaces** for more information.

**Figure 25 Typical Data on Discharge Cycles of 91 to 240 Seconds Duration During the Recording Period**

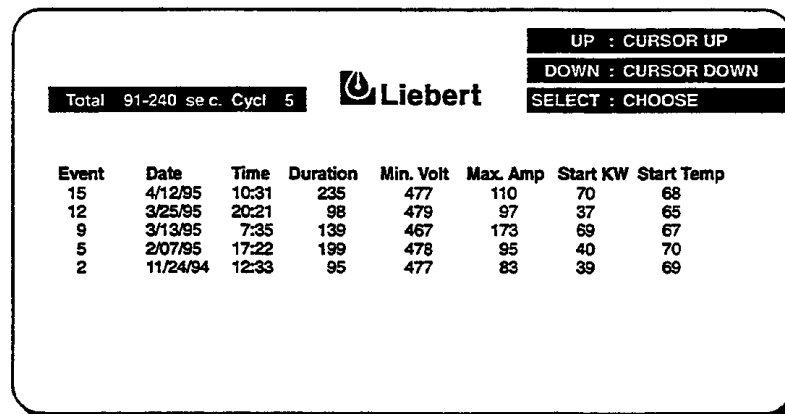

### 3.1.5 System Configuration Screens

Go to the Master Menu and move the highlighted cursor to **SYSTEM CONFIGURATION**. Press the **Select** pad and the System Configuration screen is displayed.

The System Configuration screen lists parameters that can be changed to adjust the “personality” of your UPS module to your site requirements. Some of the information displayed is factory set and should only be changed by Liebert Customer Service and Support. Parameters that should be adjusted by the user include date, time, auto dial number, and modem baud rate.

The System Configuration screen is one of the displays that has controlled access to limit who is able to change site parameters. This type of screen is called a Security Access screen. This controlled access feature allows anyone to review the present parameters, but limits access for making changes. When you see Security Access displayed on the screen (upper left corner), to make authorized changes you must open the control cabinet door (key required) and push the **Interlock** button on the back of the control panel (**Figure 9**). Close and lock the control cabinet door after making authorized changes.

**Figure 26 System Configuration Screen**

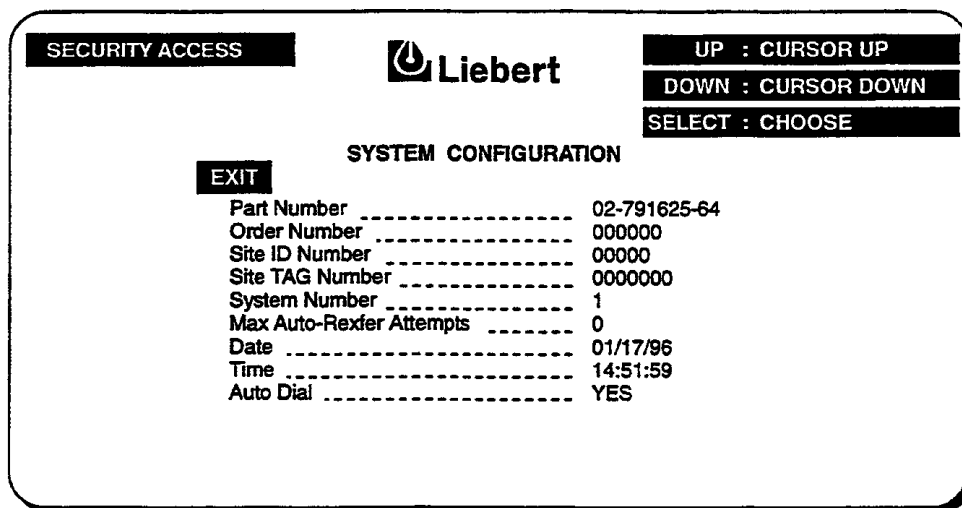

#### NOTE

*If you accidentally set a site parameter digit to a wrong value, you must return to the System Configuration screen and go again to your desired screen.*

**Part Number.** This is a factory set part number of the UPS module which determines many internal operating parameters. It cannot be changed.

**Order Number.** This is a factory set number to identify your particular installation.

**System Number.** This number is used to identify one or more UPS systems that may be present on one site.

---

## Date

This is the system's real time date setting. To reset the date, do the following:

Figure 27 Date Screen

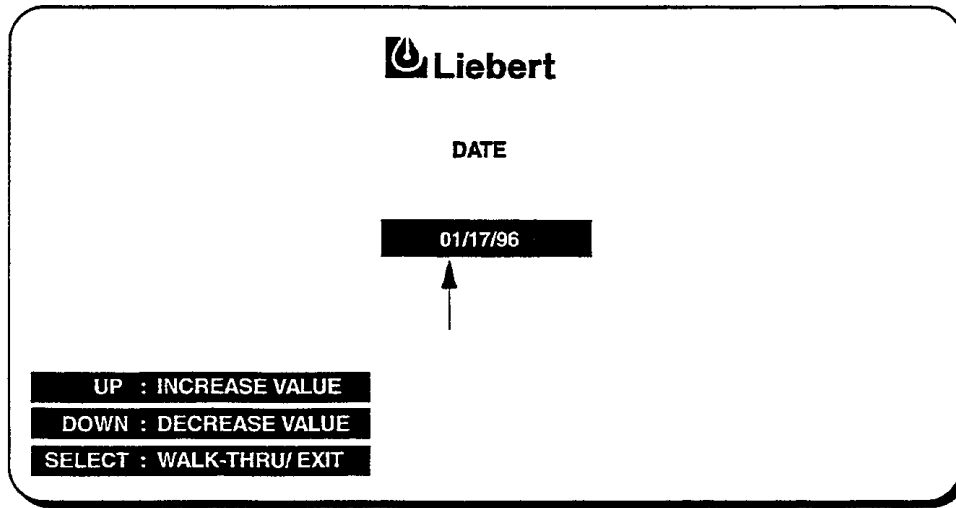

1. From the System Configuration screen, press the **Up** or **Down** pad to move the highlighted cursor to **DATE**.
2. Press the **Select** pad. The Date screen will appear.
3. Press the **Select** pad to move the arrow to the next digit to the right.
4. When the arrow is on the digit to be changed, press the **Up** pad to increase the number or the **Down** pad to decrease it. Press **Select** to set the value and move to the next digit.
5. After the correct month/day/year has been set, press the **Select** pad again to return to the System Configuration screen.



### NOTE

*Precise Date and Time functions are required for accurate archive and event history purposes.*

*Both the Date and Time can be set from a remote terminal. Refer to 3.1.14 - Communication Interfaces.*

---

## Time

This is the system's real-time clock. To reset the time do the following:

**Figure 28 Time Screen**

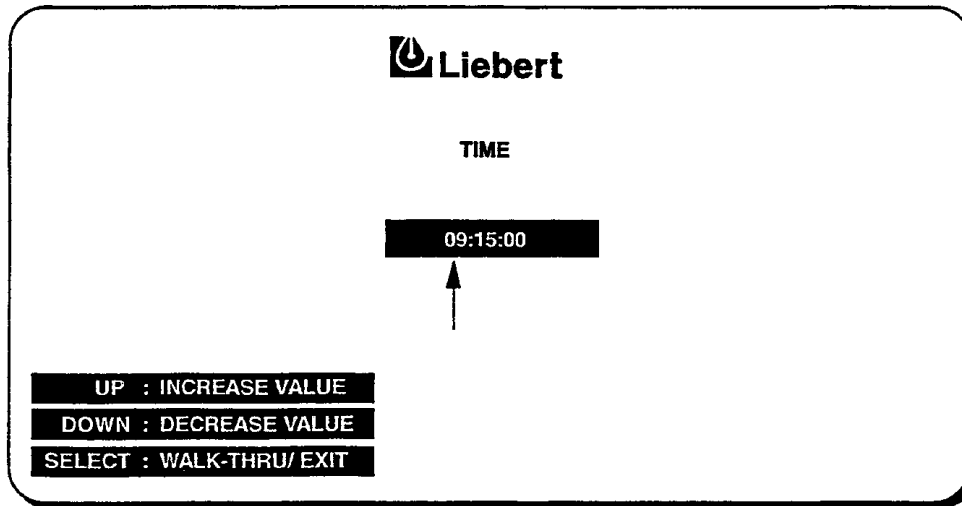

1. From the System Configuration screen, press the **Up** or **Down** pad to move the highlighted cursor to **Time**.
2. Press the **Select** pad. The Time screen will appear.
3. Press the **Select** pad to move the arrow to the next digit to the right.
4. When the arrow is on the digit to be changed, press the **Up** or **Down** pad to increase or decrease the hour/minute/second number. Press **Select** to set the value and move to the next digit.
5. After the correct hour/minute/second has been set, press the **Select** pad again to re turn to the System Configuration screen.



### NOTE

*Precise Date and Time functions are required for accurate archive and event history purposes.*

*Both the Date and Time can be set from a remote terminal. Refer to **3.1.14 - Communication Interfaces**.*



## Auto Dial

This is a feature that automatically dials (through a customer supplied Hayes<sup>1</sup>-compatible modem) a preprogrammed telephone number (up to 12 digits) when specified alarm conditions occur within the UPS system. Automatic dial attempts to the first number are made at periodic intervals for 30 minutes. If unanswered, the system rolls over to the second number and repeats the process until connection is made.

Upon connection, the system transmits data, in RS-232C format, that includes the system identification code, the present alarm message(s) and the time that the alarm(s) occurred. Refer to **Table 1** and **Table 2** to see which alarm messages will initiate an auto dial call. Refer also to **3.1.14 - Communication Interfaces**.

Figure 29 Auto Dial Setting Screen

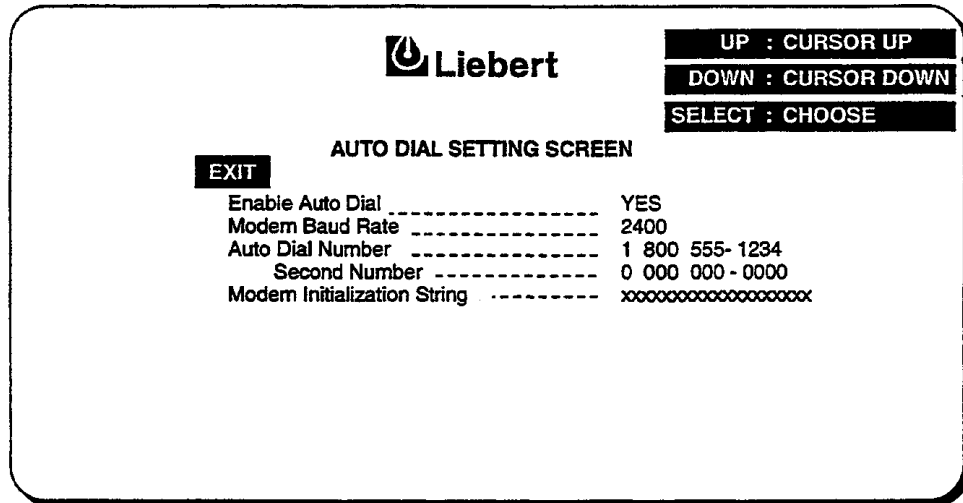

If the auto-dial numbers were specified at time of order, the numbers are preprogrammed into the system. However, if the numbers need to be changed, follow the steps listed below to reprogram the auto-dialer.

1. From the System Configuration screen, press the **Up** or **Down** pad to move the highlighted cursor to **Auto Dial**.
2. Press the **Select** pad. The Auto Dial screen will appear.
3. Move to and select the first Auto Dial number.
4. Press the **Select** pad to move the arrow to the next digit to the right.
5. When the arrow is on the digit to be changed, press the **Up** pad to increase the number or press the **Down** pad to decrease it. Press **Select** to set the value and move to the next digit.
6. After all of the changes have been made, press the **Select** pad again to return to the System Configuration screen.
7. If required, go to the **Second Number** and enter the correct number.

1. Hayes is a Registered Trademark of Hayes Microcomputer Products, Inc.

---

## Modem Baud Rate

This sets the transmission rate at which the system relays data to a terminal through the modem.

Figure 30 Modem Baud Rate

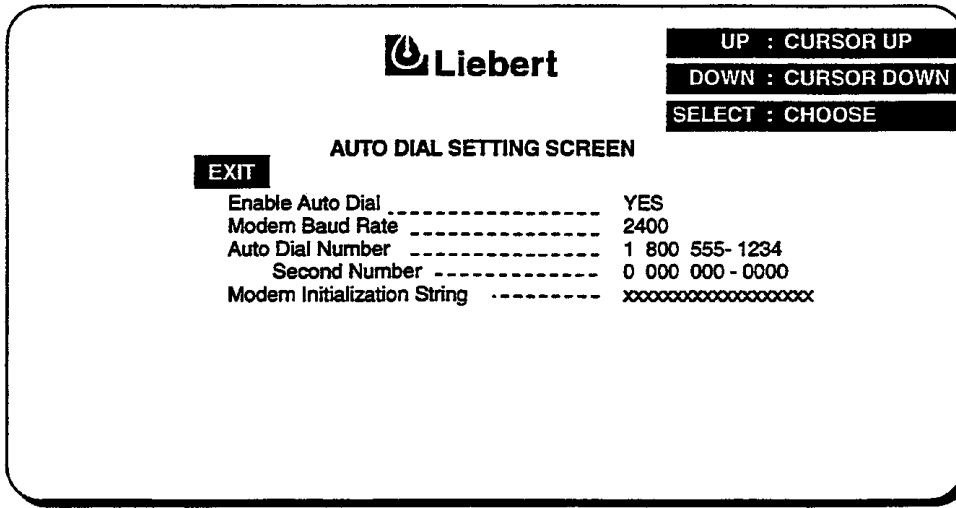

To change the modem baud rate, do the following:

1. From the System Configuration screen, press the **Up** or **Down** pad to move the highlighted cursor to **Auto Dial**.
2. Move to and select the Modem Baud Rate.
3. Press the **Up** or **Down** pad to display the desired baud rate.
4. Press the **Select** pad to set the baud rate and to return to the System Configuration screen.

---

## Maximum Auto-Retransfer Attempts

When a UPS output overload condition exceeds a pre-programmed current-versus-time window, the UPS automatically transfers the critical load to the bypass line. After the overload condition has been corrected, the UPS attempts to automatically retransfer the critical load to the UPS output (unless zero attempts is selected). The **Maximum Auto-Retransfer Attempts** limits the number of times (0 to 5) that the UPS attempts to retransfer the load back to the UPS within a one-hour time period. Refer to **3.4.3 - Automatic Retransfers to UPS**.

If more than the selected number of overloads occurs during one hour, the critical load remains on the bypass line and must be manually retransferred to the UPS. Note that you should determine the cause of any overload condition.

**Figure 31 Maximum Auto-Retransfer Attempts Screen**

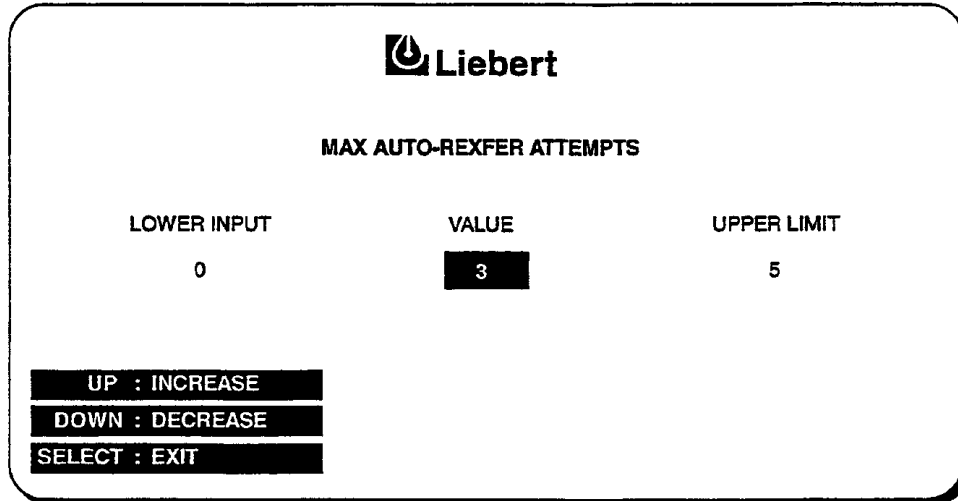

To change the Maximum Auto-Retransfer Attempts parameter, do the following:

1. From the System Configuration Screen, press the **Up** or **Down** pad to highlight **Maximum Auto-Retransfer Attempts**.
2. Press the **Select** pad. The above screen will appear.
3. Press the **Up** pad to increase the value or the **Down** pad to decrease it.
4. Press the **Select** pad to set the value and to return to the System Configuration screen.

---

## Remote Monitor

The Remote Monitor Panel (optional) displays eight (8) alarms.

These alarms are also available for customer use through a set of contacts on a separate terminal board.

When the New Alarm or System Summary Alarm is activated, you can get more information at the Operator Display Panel or through a remote terminal. Refer to **3.1.14 - Communication Interfaces**.

<b>Standard Remote Monitor Indications</b>	<b>Channel</b>
Load On UPS	CH1
Load On Bypass	Ch2
Battery Discharging	CH3
Low Battery Warning	CH4
Overload	CH5
Ambient Over-Temp	CH6
System Summary Alarm	CH7
New Alarm Channel	CH8

The following alarms, as well as those listed above, will activate the System Summary Alarm.

<b>Other Alarms That Activate System Summary Alarm</b>
Battery CB Open
Blower Failed
Control Power Fail
DC Capacitor Fuse Blown
DC Ground Fault
DC Over-Voltage Shutdown
Emergency Off
Equipment Over-Temperature
Inverter Fuse Blown
Low Battery Shutdown
Output Over/Under Frequency
Output Over-Voltage
Output Under-Voltage
Overload Shutdown
Overload Transfer
Rectifier Fuse Blown
Reverse Power
Static Switch Unable

### 3.1.6 Alarm Limit Settings Screen

Go to the Master Menu and move the highlighted cursor to LIMIT SETTINGS. Press the Select pad and the Limit Settings screen is displayed.

The Alarm Limit Settings screen has Security Access to enable an authorized Liebert field service engineer to adjust the UPS system alarm limit settings.



#### CAUTION

All alarm limit settings are application matched and factory set. They should not be changed casually. Contact Liebert Customer Service and Support for changing the alarm limit settings.

Figure 32 Alarm Limit Settings Screen

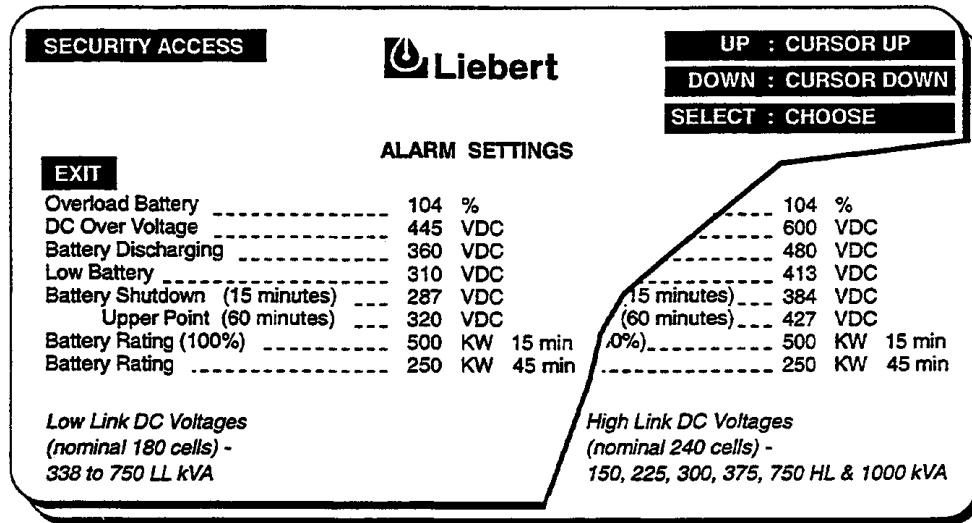

**Overload Alarm.** This alarm setting initiates an alarm message on the display screen warning the operator that the UPS module output current has exceeded the specified limit. This condition only activates an alarm. The UPS does not shutdown, but a separate control circuit will transfer the critical load to bypass if the current and time of the overload condition exceeds system capability.

**DC Over-Voltage.** This setting limits the maximum permitted level of the DC bus voltage. When this setting is exceeded, an alarm indication appears on the display screen, the UPS transfers the load to the bypass line, and the input and battery circuit breakers trip open.

**Battery Discharging.** When the battery voltage on the DC bus falls below this limit for 5 seconds, a Battery Discharging alarm message is displayed on the screen. This means that the battery is discharging due to an input voltage sag or interruption, or an output overload.

**Low Battery.** While the battery is discharging, this alarm warns the operator that the Battery Shutdown level is approaching. This is typically set for a reserve time of at least five minutes (10 to 20 volts above Battery Shutdown), based on full load operation.

**Battery Shutdown (15 Minutes).** When the battery voltage decreases to this limit for five seconds during the first 15 minutes of the discharge the battery circuit breaker opens to prevent over-discharge. Note that the rated battery reserve time at your site may be other than 15 minutes.

**Battery Shutdown (60 Minutes).** During extended outages or deep sags of more than 15 minutes, the shutdown voltage limit will ramp up gradually to this 60-minute limit to prevent lengthy discharge and possible battery damage. The battery circuit breaker opens when the battery voltage and the shutdown limit are equal for five seconds. See the Battery Time screen for more information. Also refer to the battery manufacturer's manual.

---

**Battery Rating (100%).** This setting is the full load discharge rating of the battery in kilowatts for the rated backup period. A typical rating might be 500 kW for 15 minutes.

**Battery Rating.** This setting is a battery discharge rating in kilowatts under partial load for an extended period, typically 60 minutes. The UPS uses the two battery shutdown voltage settings and the two battery discharge ratings in computing rated and calculated time remaining during a discharge event.



**CAUTION**

The **LOW BATTERY** alarm setting is designed to be useful at full load battery discharge rates. If the discharge period extends past 15 minutes (i.e., the load on the UPS is less than full capacity), the Battery Shutdown voltage setting is gradually and automatically increased, to protect the batteries from deep discharge. The **LOW BATTERY** alarm setting, however, does not receive this type of automatic increase. Therefore during extended battery discharges (beyond 20 minutes), the adjusted shutdown voltage will eventually be higher than the **LOW BATTERY** alarm setting and the UPS could shut down without sounding the **LOW BATTERY** alarm. The operator should consult the Battery Time screen or Present Status screen to see the calculated time remaining based on actual usage during the discharge period.

### 3.1.7 Load Transfer Procedures

#### Screen

Go to THE Master Menu and move the highlighted cursor to **LOAD TRANSFER PROCEDURES**. Press the **Select** pad and the Load Transfer Procedures screen is displayed.

The Load Transfer Procedures screen contains instructions to transfer the critical load between the UPS output line and the bypass line. Comparisons of the UPS and bypass voltage, frequency, and phase synchronization are displayed along with transfer status messages and an indication of circuit breaker overlap time. The metered parameter values on the Load Transfer Procedures screen are updated at half second intervals.

Refer to 3.3.2 - Load Transfer Procedures for more details.

Figure 33 Load Transfer Procedures Screen

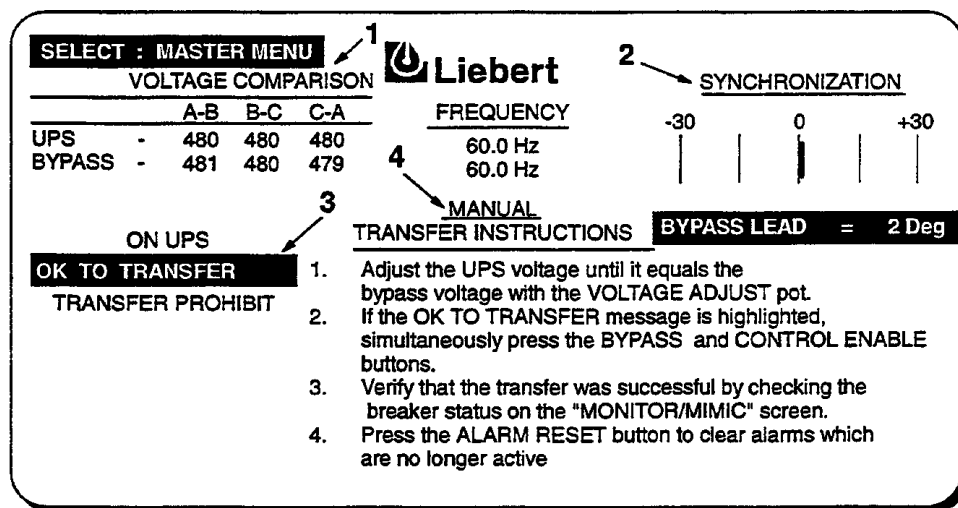

**Item 1 - Voltage Comparisons.** This chart shows the UPS and bypass voltage and frequency comparisons between each of the three phases. If the UPS and bypass voltages are not within specified tolerances, a manual transfer is not permitted and **TRANSFER PROHIBIT** highlighted.

The Voltage Adjust knob (push-to-turn), located on the Operator Control Panel (**Figure 10**), is used to match the UPS output voltage to the bypass voltage. When the UPS and bypass voltages match within the specified tolerance, a manual transfer is possible and **OK TO TRANSFER** highlighted.

**Item 2 - Synchronization.** This display shows the phase synchronization between the UPS output and bypass power. If the phase displacement is outside of the tolerance, a manual transfer is not permitted and **TRANSFER PROHIBIT** is highlighted.

During normal operation, the synchronization display should read UPS LEAD from zero to 4 degrees.

**Item 3 - Status Messages.** Three messages are constantly displayed here. Only the active message is highlighted. If **TRANSFER PROHIBIT** is highlighted manual transfers/retransfers cannot be performed, and automatic retransfers will not be initiated.

**Item 4 - Manual Transfer Instructions.** These instructions assist the operator in transferring the critical load between the UPS and the bypass line.

If the load is on the bypass line, step 2 on the screen will instruct you to press the **UPS** and **Control Enable** buttons to retransfer the load from the bypass line to the UPS.

### 3.1.8 Start-Up Procedures Screen

From the Master Menu, move the highlighted cursor to **START-UP PROCEDURES**. Press the **Select** pad and the Start-Up Procedures screen is displayed.

This two-page screen contains the steps you must follow to start-up the UPS system. The instructions are listed so you can review them prior to performing the start up.

Figure 34 Start-Up Procedures Screen

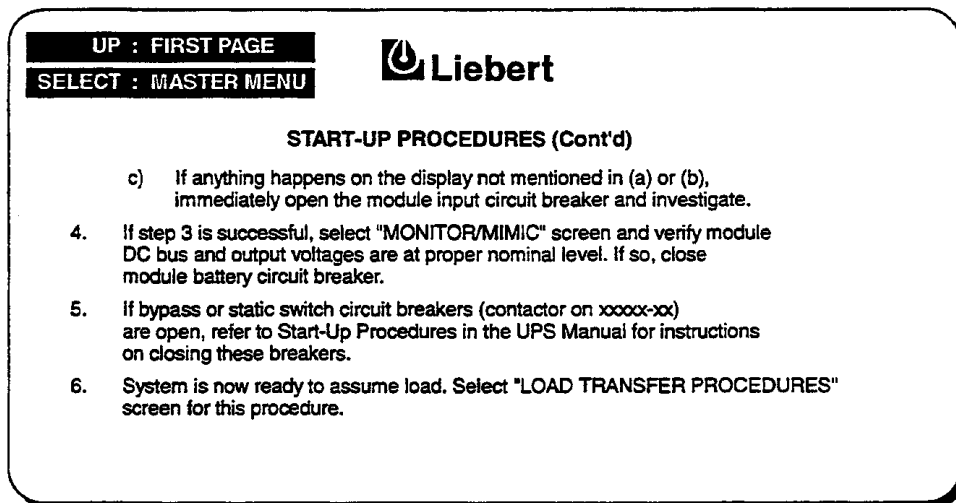
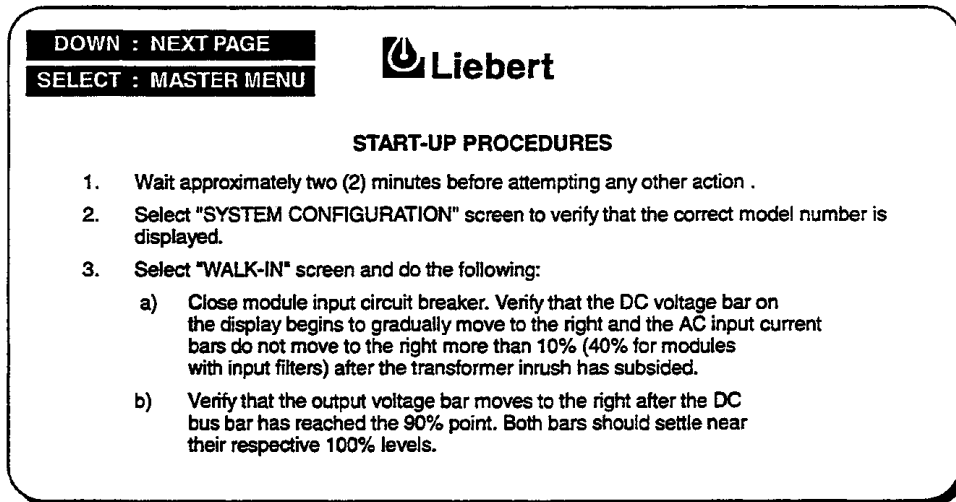

Prior to this procedure, supply power to the critical load through the bypass line. When you close the UPS input circuit breaker, power is provided to the UPS rectifier. The module DC bus voltage ramps up to the nominal battery voltage and the UPS inverter turns on when the DC bus reaches the proper voltage. You can then close the battery circuit breaker, and transfer the load from bypass to UPS output per instructions on the Load Transfer Procedures Screen.

Refer to **3.3.1 - Start-Up Procedures** for more details.



### 3.1.9 Shutdown Procedures Screen

Go to the Master Menu and move the cursor to **SHUTDOWN PROCEDURES**. Press the **Select** pad and the Shutdown Procedures screen is displayed.

This two-page screen contains the steps you must follow to perform a controlled shutdown of the UPS system. The instructions are listed so you can review them before performing the controlled shutdown

Figure 35 Shutdown Procedures Screen

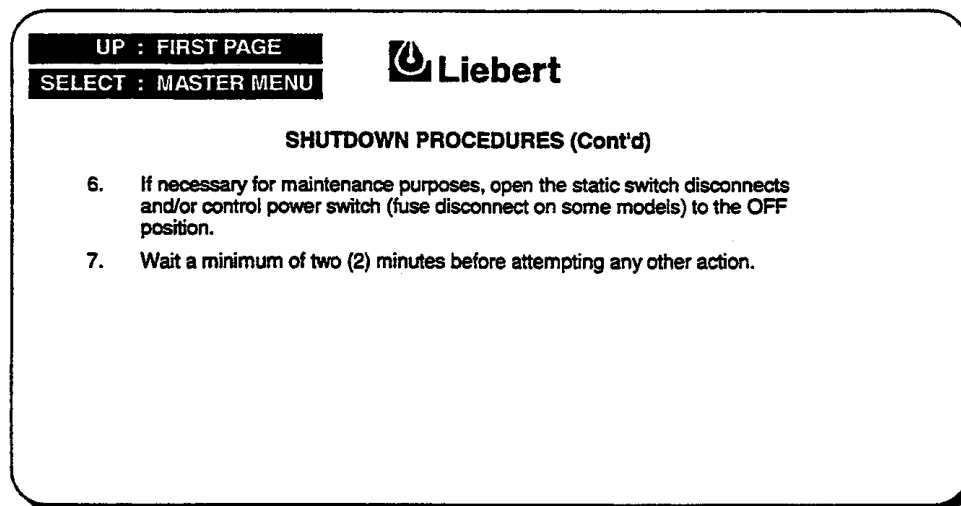
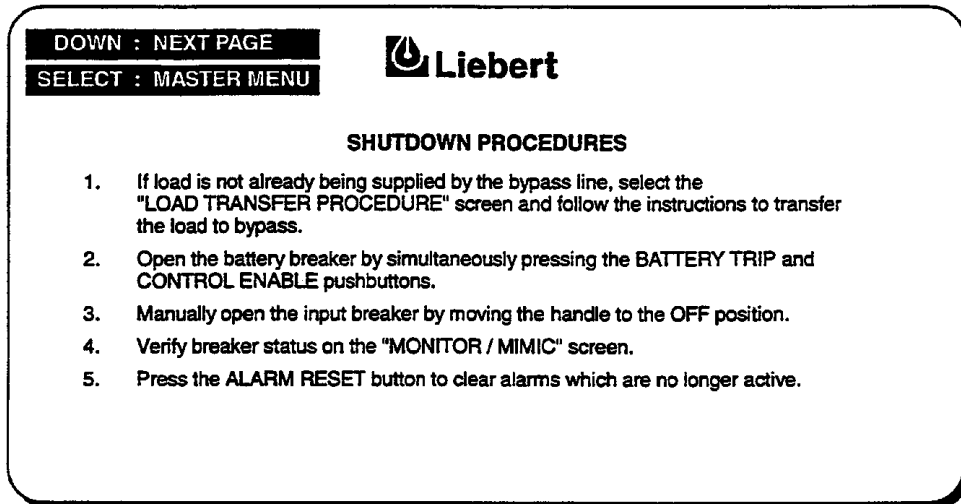

To perform the shutdown procedure, transfer the critical load from the UPS to the bypass line. Then open the battery circuit breaker and manually open the UPS input circuit breaker. The **Control Power** switch may be turned Off if required for maintenance procedures.

Refer to **3.3.3 - Shutdown Procedures** for more details, including module shutdowns for service and emergency shutdowns.

### 3.1.10 Battery Time Screen

At the Master Menu, move the highlighted cursor to BATTERY TIME. Press the Select pad and the Battery Time screen is displayed.

When AC power is not available to the UPS module, the UPS inverter uses DC power from the battery to supply the critical load. This screen helps the operator assess his power resources to determine if and when the critical load shutdown procedures need to be started.

The Battery Time screen, as shown in **Figure 36**, is a line graph that tracks the present battery voltage versus the elapsed time that the battery has been discharging. As the battery voltage decreases, the line representing it moves closer to intersecting the line that represents the battery shutdown voltage. When the battery starts to discharge, the screen displays a 15-minute graph. If the battery has been providing power for more than 15 minutes, the screen displays a 30-minute graph. If battery power is still available after 30 minutes, a 60-minute graph is displayed.

**Figure 36 Battery Time Screen Example - 15 Minute Discharge**

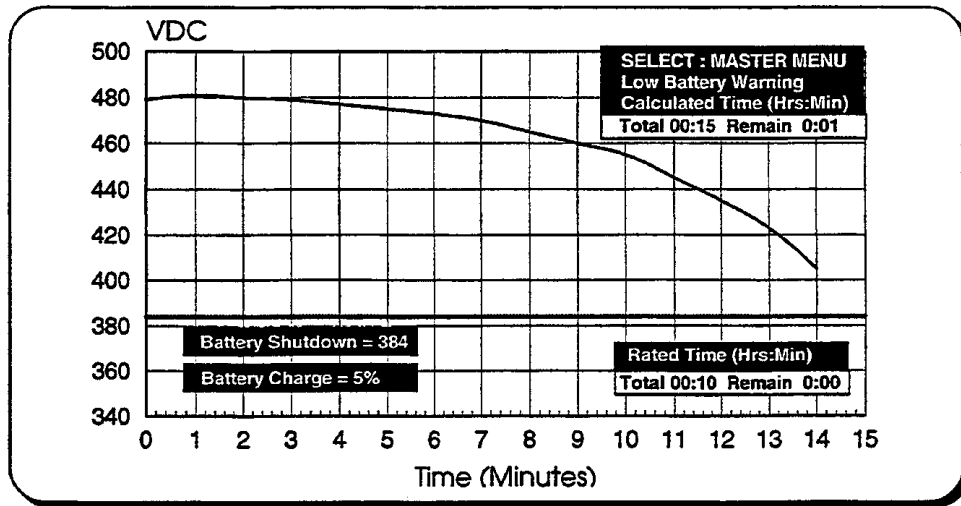

The screen also displays alarm messages (Battery Discharging, Low Battery Warning, and Battery Shutdown) and a set of five parameters that inform the operator of battery condition and time remaining. The five parameters describing battery resources are:

- Rated Total Time, in hours and minutes, is the amount of battery backup time that should be available under full rated load, based on system design.
- Rated Time Remaining is the Rated Total Time less the duration of the present discharge event.
- Calculated Total Time is an estimate of the total battery backup time available, based on the initial battery condition and actual performance while powering the connected load during the discharge event.
- Calculated Time Remaining is a real-time estimation of battery time remaining—with the actual connected load—before battery voltage drops to the Battery Shutdown setpoint.
- Battery Charge is the approximate percentage of total designed ampere hours of battery capacity presently available based on recharge/discharge activity.

Values for Calculated Total Time and Calculated Time Remaining will appear on the screen approximately two minutes after the beginning of the discharge event. Calculated Time Remaining also appears on the Present Status Report screen. Both Calculated Total Time and Calculated Time Remaining will be updated every six seconds, reflecting actual load changes and battery condition. When the Calculated Times become available, they will be displayed in place of the Battery Discharging message on this screen.

Figure 37 Battery Time Screen Example - 45 Minute Discharge

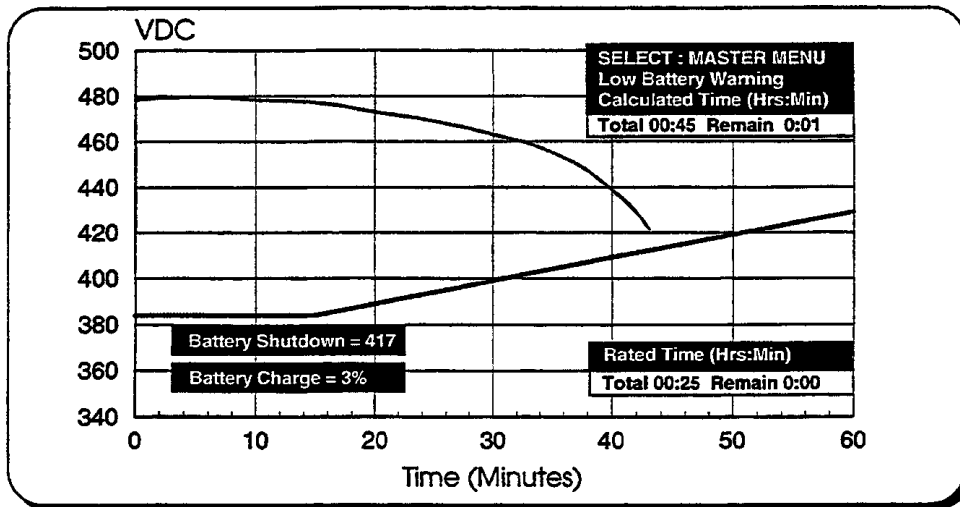

The Battery Time Remaining graph and the Calculated times are extremely helpful to the operator who has the discretionary authority to order load-shedding activities. The Series 600 automatically samples battery voltage and load current and recomputes every six seconds. This gives the operator fast and accurate feedback on efforts to extend battery time remaining by shutting down non-critical loads.



#### NOTE

While every effort has been made to make the Rated and Calculated Time Remaining values as accurate as practical, these values must be regarded as approximations. At the beginning of the discharge cycle, the Calculated times could be off by as much as 20% due to such variables as battery initial charge, age of battery, and the subsequent loadshedding activities of the operator. Within a few minutes, however these calculations will settle into their design accuracy of 10%, with the end-of-discharge tolerance being +0, -10% of actual observed time. In addition, the operator can adjust the settings affecting Rated Total Time after gaining experience with the actual battery and connected load.

The Series 600 dynamically adjusts the Battery Shutdown voltage based on battery characteristics and the length of the current discharge event. If a discharge event extends past 15 minutes (i.e., the load is less than the full design rating), the Battery Shutdown voltage setting is gradually and automatically increased, to protect the batteries from deep discharge.

When the battery voltage decreases to a preset limit (see **3.1.6 - Alarm Limit Settings Screen**), the Low Battery Warning alarm message appears on the display screen. This warns the operator that the battery voltage is approaching the Battery Shutdown level—about five minutes of time remaining at full rated load.



#### NOTE

The Low Battery alarm setting is designed to be useful at full Load battery discharge rates. Unlike the Battery Shutdown voltage, the Low Battery alarm setting is not automatically increased, and should not be relied upon as an indicator of battery time remaining. Instead, the operator should consult the Battery Time screen or Present Status screen to see the Calculated Time Remaining based on actual usage during the discharge period.

If the battery discharges to the Battery Shutdown level, represented by the lower line on the Battery Time screen, the battery and input circuit breakers trip open and the UPS module is shut down. This protects the battery from being damaged by deep discharging.

Figure 38 Tolerance Range of Values for Calculated Battery Times

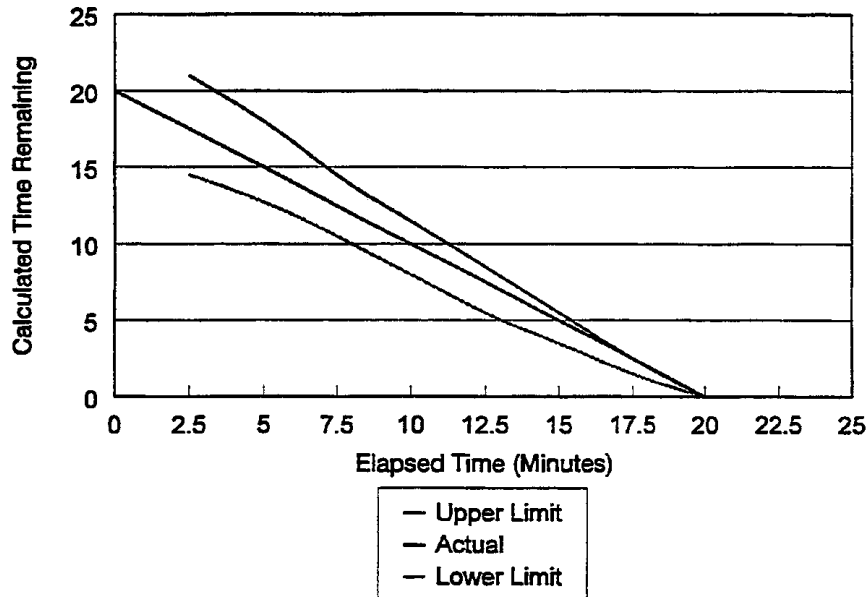

#### CAUTION

When battery shutdown occurs, no power will be supplied to the critical load unless power is available through the bypass line (or from an engine generator set). If you anticipate a battery shutdown (and an engine generator set is not available), either transfer the load to bypass (if available) or perform a controlled shutdown of the critical load.

If the Battery lime screen is displayed while the battery is not discharging, it will display the present Battery Charge percentage and the results of the previous discharge event.



#### NOTE

1. During initial UPS start-up, the Battery Charge will display 100%. It will actually take three to four days of operation to completely charge the battery. After the battery is fully charged the first time, Battery Charge will be an accurate indication of battery status.
2. If Calculated Time Remaining is less than Rated Time Remaining, a battery problem is likely. Battery maintenance personnel should thoroughly examine the battery plant for factors which may reduce battery performance, such as:
  - Age of battery
  - Excessive battery discharge/recharge cycles
  - Bad or weak cells
  - Low acid in flooded cells
  - Loose electrical connections
  - Ambient temperature extremes
  - Dirty battery jar covers
3. If the battery plant has been thoroughly examined for proper maintenance and condition, and the Calculated value is still less than 80% of Rated value, contact Liebert CS&S.

The Series 600 records information about each discharge event. If your system has the Battery Cycle Monitor software, this data can be reviewed on the Battery Cycle Monitor screen, as described in 3.1.4 - Status Reports Screens.

### 3.1.11 Meter Calibration Screen

Go to the Master Menu and move the highlighted cursor to **METER CALIBRATION**. Press the **Select** pad and the Meter Calibration screen is displayed.

The Meter Calibration screen enables a Liebert field-service engineer to adjust the calibration of the UPS metered functions. Access to these settings is limited by the Security Access control.



#### CAUTION

Meter calibrations are factory set and should not require adjustment. Contact Liebert Customer Service and Support for meter calibration.



#### WARNING

DO NOT ATTEMPT TO CALIBRATE METERS WITHOUT ADEQUATE TRAINING. METER CAT CALIBRATION REQUIRES SPECIAL TEST EQUIPMENT ACCESS TO TEST POINTS IN SENSITIVE CIRCUITRY, AND EXPOSURE TO HAZARDOUS VOLTAGE.

Figure 39 Meter Calibration Screen

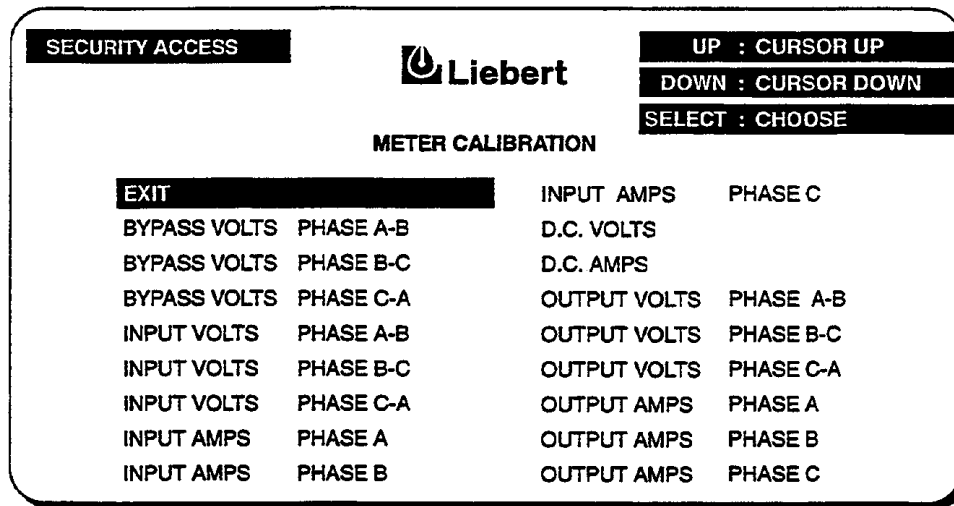

### 3.1.12 Battery Equalize Screen

Go to the Master Menu and move the highlighted cursor to **BATTERY EQUALIZE**. Press the **Select** pad and the Battery Equalize screen is displayed.

The Battery Equalize screen enables the operator to adjust the battery equalize time. It is also used to choose between auto and manual battery equalize recharging modes.

When the input utility power is interrupted, the battery supplies DC power to the inverter so there is no interruption of power to the critical load. When the AC input power is restored, the battery equalize recharging circuit can be activated automatically or manually to increase the rectifier/charger output voltage to recharge the battery. The battery equalize circuit may also be manually activated at any time during normal float (constant) voltage operation. The equalizing time can be adjusted from 0 to 72 hours.

Figure 40 Battery Equalize Screen

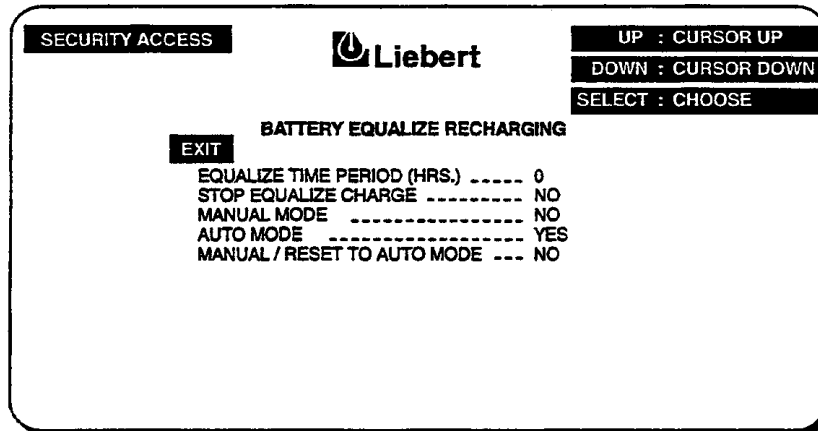

#### CAUTION

Do not use the Battery Equalize mode if you have valve regulated (sealed cell maintenance free) batteries. Refer to your battery manufacturer's manual.

**EQUALIZE TIME PERIOD.** This selection permits the operator to adjust the battery equalize time in one hour increments from 0 to 72. The battery equalize time must be greater than zero for the battery to begin recharging in both the **AUTO** and the **MANUAL** modes. This period is set by use of the **Up/Down** pads and **Select** pad.

When the battery is at full voltage (not being recharged), this selection reads **EQUALIZE TIME PERIOD (hrs)**. When the battery is recharging this selection reads **EQUALIZE TIME REMAINING (hrs)**. After the equalize recharge time has expired, the indication returns to the preset equalize time.

**STOP EQUALIZE CHARGE.** This selection lets the operator halt the equalizing charge to the battery at any time, whether the circuit was activated automatically or manually.

**MANUAL MODE.** This mode enables the operator to manually initiate a battery equalize charge to raise the DC bus voltage to correct a non-uniformity in the individual cell voltages or specific gravity readings.

**AUTO MODE.** When the battery recharge control logic is in the **AUTO MODE**, the battery charger attempts the equalization process only if the **EQUALIZE TIME PERIOD** is greater than zero, the battery voltage has been at or below the Battery Discharging alarm limit longer than 30 seconds, and the battery breaker (MBD) is closed.

### 3.1.13 Alarm and Status Messages

Figure 41 Status and Alarm Message Areas

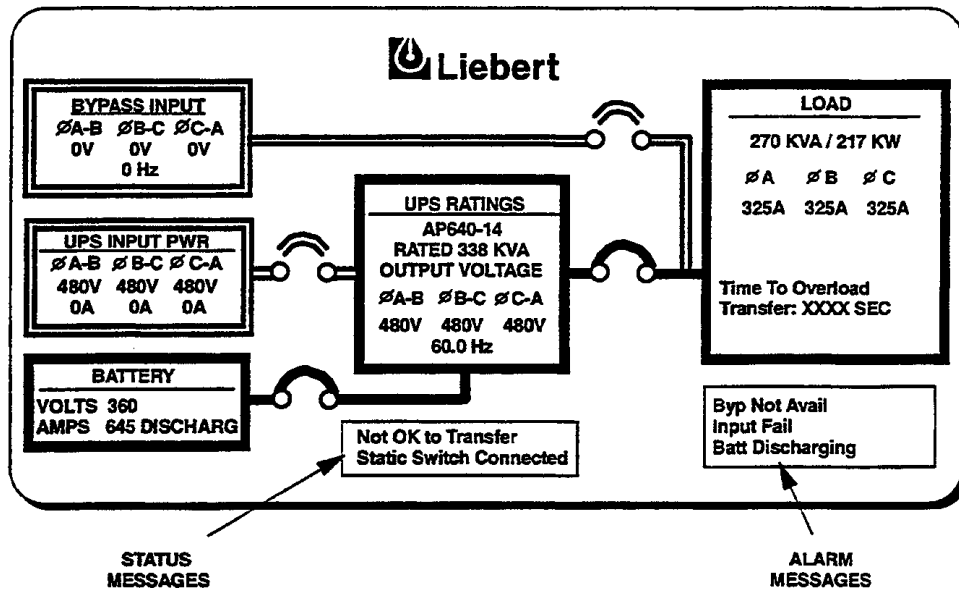

#### Status Messages

The status messages indicate whether the static bypass switch is connected or disconnected, through the manually operated **Static Switch Disconnects** (Figure 7 and Figure 8). The status messages also advise the operator when a transfer or retransfer between the UPS and bypass line is permitted, based on matching voltage, frequency, and phase.

The following status messages may appear in the system status area

- Static Switch Connected.** The static switch is connected (the disconnect switches are closed ON) and is ready to provide a current path from the bypass input to the load.
- Static Switch Disconnected.** The static switch is disconnected (the disconnect switches are open—OFF) for maintenance procedures.
- Ok to Transfer.** The UPS voltage, frequency, and phase match the bypass line. This means that a transfer between the bypass line and the UPS is permitted.
- Not Ok to Transfer.** Either the UPS or bypass voltage, frequency, or phase is not within the specified limits or the static bypass switch is not available. Therefore, manually initiated transfer between the bypass line and the UPS system is not permitted. Emergency or overload transfer to bypass may still be available provided the “static switch unable” alarm is not indicating.
- Time to Overload Transfer.** During an overload condition, the time remaining before transfer (in seconds) is displayed at the bottom of the load block.

---

## Alarm Messages

The alarm message area displays the alarm conditions that are present within the UPS system. Alarm messages are displayed in flashing reverse video. During normal operation no alarm messages should be present. Up to four messages are displayed. To see if any additional alarm conditions are present in the UPS system, display the Present Status screen on the control panel.

**Table 1** is a complete list of all alarm messages and corrective actions, if any.

The **first column** lists the alarm message, with related alarms grouped together.

The **second column** indicates which special functions (if any) are initiated by the alarm.

**D** - the alarm initiates an auto-**dial** call through a user-provided modem to a remote terminal

**E** - message displayed only on Status Report screens including **Event** History.

**F** - the alarm **freezes** the History Status Report memory buffer. Pressing the Alarm Reset pad for 5 seconds will unfreeze the memory buffer.

**L** - the alarm **latches** the displayed alarm message. Some alarm conditions are temporary (transient) and may not last long enough to be noticed. Latching the display (keeping it on) lets you know that an alarm condition has occurred. A latching display alarm remains on the display screen until the alarm condition is removed **and** the **Alarm Reset** pad is pressed.

**R** - the alarm is displayed on an (optional) **Remote** Monitor Panel. This information is also available for customer use through a set of contacts on a separate terminal board.

**S** - the alarm initiates a **summary** alarm at the Remote Monitor Panel.

The **third column** provides an explanation of the alarm condition, the critical bus status, and the corrective actions, if any, to remedy the alarm.

Abbreviations Used in Alarm Messages	
Auto	Automatic
Avail	Available
Batt	Battery
Byp	Bypass
Cap Fuse	Capacitor Fuse
Cont Power	Control Power
Equip	Equipment
H/W	Hardware
Inv Fuse	Inverter Fuse
OF/UF	Over/Under Frequency
Ov-temp	Over-Temperature
O-volt	Over-Voltage
O-volts	Over-Voltage
Ph Seq	Phase Sequence
Rect Fuse	Rectifier Fuse
Rexfer	Retransfer
Shutdn	Shutdown
Static Sw	Static Switch
Un-volts	Under-Voltage
Xfer	Transfer



**Table 1 Alarm Messages - Meaning and Corrective Action**

Alarm Message	Special Functions	Meaning and Corrective Action in Brackets [ ]
<b>AC INPUT</b>		
Input Fail	—	The rectifier input line voltage is outside of specified limits or the input circuit breaker is opened while the battery circuit breaker remains closed. The battery supplies power to the critical load through the UPS inverter.
<b>DC BUS</b>		
DC Ground Fault	L, S	Either the positive (+) or negative (-) DC bus is grounded. No transfer or shutdown occurs. [Contact Liebert Customer Service & Support at once. Do not attempt to locate or repair the fault.]
DC Capacitor Fuse Blown	D, F, S	At least one DC capacitor fuse has opened. The UPS module is shut down and isolated. [Contact Liebert Customer Service & Support at once. Do not attempt to reset the circuit breakers.]
Battery CB Open	S	The module battery circuit breaker (MBD) is open. This circuit breaker can be opened either manually or automatically in a UPS shutdown procedure. If the UPS is operating with this breaker open, <b>the critical load is not protected from loss of the utility source power.</b> [After AC power is restored and the DC bus is at 100% operating voltage, manually close the battery circuit breaker so the rectifier can charge the battery.]
Battery Discharging	R, S	The battery is discharging. This occurs whenever the battery supplies power to the load for more than 5 seconds because of input power failure, a rectifier problem, or an overload condition. If the input power or a source of auxiliary power is restored to the UPS module, the UPS automatically returns to normal operation. [Watch the battery voltage carefully. Reduce the load (begin controlled shutdown) to extend the battery back-up time. Reset the UPS alarms after the input power is restored.]
Low Battery Warning	R, S	The battery voltage is approaching the minimum discharge voltage (5 or more minutes remaining). [Complete the controlled shutdown of the critical load. Reset the alarms if the input power is restored before shutdown.]
Low Battery Shutdown	D, F, L, S	The battery voltage has decreased to the minimum discharge value. The UPS module shuts down (no power to the critical load) and the battery and input circuit breakers trip open. The load will transfer to the bypass line if the bypass source is available. [Perform a UPS system start-up procedure when AC power becomes available.]
DC Over-Voltage Shutdown	D, F, L, S	The maximum preset value of the DC Bus voltage has been exceeded. The UPS transfers the load to bypass and the input and battery circuit breakers trip open. [Contact Liebert Customer Service & Support at once. A fault may have occurred within the UPS. Do not attempt to reset the circuit breakers.]
<b>BYPASS</b>		
Load On Bypass	R	The critical load is being supplied power from the bypass line, and is therefore exposed to utility power disturbances. [Clear all of the alarms before attempting to retransfer the load from the bypass line to the UPS.]
Auto Transfer to Bypass	D, E, F	The critical load has been automatically transferred to the bypass line. [Use the History Status screen to determine the cause for the transfer. Clear all of the alarms before attempting to retransfer the load from bypass to UPS.]
Auto Retransfer Primed	—	An automatic retransfer will be initiated when the Ok to Transfer condition has been present for 10 seconds and the overload has dropped below 100% of the rated load.
Manual Reset/Retransfer	—	A manual retransfer is required. Either an overload condition has lasted more than 5 minutes, or no more auto-retransfer attempts are available. Note that this alarm is only used if auto-retransfer attempts are enabled. [Perform a manual retransfer if all necessary conditions are present.]

**Table 1 Abbreviations**

D = auto-dial; L = latches  
 E = reports only; R = remote  
 F = freezes; S = summary

D\* = auto-dial initiated by Auto Transfer to Bypass if load is on UPS when alarm occurs

**Table 1 Alarm Messages - Meaning and Corrective Action (continued)**

Alarm Message	Special Functions	Meaning and Corrective Action in Brackets [ ]
<b>BYPASS (Cont'd.)</b>		
Static Switch Unable	S	The UPS output is not synchronized to the bypass power source, the static bypass switch is disconnected, or it has failed internally. [Emergency and overload transfer to the bypass source is not available. Manually reset the Static Switch Disconnects to ON if the static switch is disconnected. If the alarm conditions are automatically corrected, reset the alarm to clear it. Contact Liebert Customer Service & Support if the alarm stays on.]
Bypass Not Available	—	The bypass power source voltage is not within specifications. [Check the bypass power source.]
Bypass Phase Sequence Wrong	—	The power conductors on the bypass line are not wired to the UPS in the required sequence. This alarm should appear only during initial start-up or after a repair to the source power system. [Disconnect power from the bypass line and correct the wiring. A Liebert Customer Service & Support representative must be present during initial start-up of your UPS system.]
<b>UPS SYSTEM</b>		
Input Current Unbalanced	E	At least one input phase differs from the average current by 10% or more for four (4) hours. [Contact Liebert Customer Service & Support. If the condition persists, transfer the load to the bypass line.]
Control Power Fail	L, S	The logic control power supply from the inverter is not operating properly. The UPS module continues operating but will shut down if the input power fails. [Contact Liebert Customer Service & Support immediately.]
Output Over/Under Frequency	L, S	Output frequency differs from the nominal (60 Hz) by more than 0.5 Hz. No transfer or shutdown occurs. [Contact Liebert Customer Service & Support at once.]
Output Undervoltage	D, F, L, S	The UPS module output voltage is under the minimum (-12%) deviation from nominal. The load automatically transfers to the bypass line. [If the alarm condition is no longer present, reset the alarm and retransfer the load from bypass to UPS. Contact Liebert Customer Service & Support if alarm persists.]
Output Overvoltage	D, F, L, S	The UPS module output voltage is above the maximum (+10%) deviation from nominal. The load automatically transfers to the bypass line. The UPS module is shut down and isolated. [Contact Liebert Customer Service & Support at once. Do not attempt to reset circuit breakers.]
Overload	R, S	The UPS output current exceeds the alarm set point load current. This condition causes an alarm only; the UPS does not shut down. [Determine cause of the overload. Reduce the load until the overload condition is corrected. Reset the UPS alarm.]
Overload Transfer	D, F, L, S	The load on the UPS has exceeded the current versus time window of overload capacity. The UPS system transfers the load to bypass. [Reduce the load. If the system does not initiate an automatic load retransfer, manually retransfer the critical load from the bypass line to the UPS. Reset the alarm.]
Overload Shutdown	D, F, L, S	The UPS output current has exceeded 175% of the rated full load or the overload capacity has been exceeded. The load automatically transfers to the bypass line. The UPS module is shut down and isolated. [Contact Liebert Customer Service & Support at once. Do not attempt to reset circuit breakers.]
Reverse Power	D, F, L, S	Excessive reverse power flow from the critical bus into the UPS inverter has occurred, probably because of low inverter output voltage or a phase mismatch. The load automatically transfers to the bypass line. The UPS module is shut down and isolated. [Contact Liebert Customer Service & Support immediately. Do not attempt to reset circuit breakers.]

**Table 1 Abbreviations**

D = auto-dial; L = latches

E = reports only; R = remote

F = freezes; S = summary

D\* = auto-dial initiated by Auto Transfer to Bypass if load is on UPS when alarm occurs

**Table 1 Alarm Messages - Meaning and Corrective Action (continued)**

Alarm Message	Special Functions	Meaning and Corrective Action in Brackets [ ]
<b>UPS SYSTEM (Cont'd.)</b>		
Rectifier Fuse Blown Inverter Fuse Blown	D, F, S D, F, S	At least one of these fuses has opened. The UPS automatically transfers the critical load to the bypass line. Circuit breakers trip open to shut down and isolate the UPS module. [Contact Liebert Customer Service & Support immediately. Do not attempt to reset the circuit breakers.]
Hardware Shutdown	D*	At least one of the following alarm conditions is present: Inverter Fuse Blown, Rectifier Fuse Blown, Reverse Power, Overload Shutdown, logic power supply failure, or inverter output symmetry failure. The load automatically transfers to the bypass line. The UPS module is shut down and isolated. [Contact Liebert Customer Service & Support at once. Do not attempt to reset the circuit breakers.]
Emergency Off	D*, L, S	The Emergency Module Off (or Emergency Power Off) switch has been pressed, which caused the UPS module to shut down and transfer the load to the bypass line (or <b>all power to the critical load has been shut down</b> ). [Determine the cause of the emergency condition and correct it if possible. Contact Liebert Customer Service & Support if you require assistance.]
Inverter Non-Synchronized	—	Inverter output is not synchronized with the UPS system critical bus. This also means the output circuit breaker is open and should not be closed until the output is in sync. [This situation may correct itself. If not, shut down the UPS and then perform a start-up procedure. Contact Liebert CS&S if condition persists.]
Battery Cycle Buffer Warning	D, E	The Battery Cycle Monitor can retain information about the last 132 battery discharge events. When the storage buffer approaches its capacity, this warning message is broadcast via terminal and modem communication channels, and a complete listing of all records is sent to the terminal port. The alarm message clears itself from the screen after 30 seconds.
<b>COOLING</b>		
Ambient Over-Temperature	R, S	The intake air to the UPS module exceeds the specified maximum temperature. [This condition only causes an alarm but should be corrected immediately to prevent damage to equipment due to overheating.]
Blower Failed	S	A fault in one or more of the blower motors has occurred. This condition only causes an alarm, but if not promptly corrected it could cause an equipment over-temperature condition that would shut down the UPS module. [Check the blowers for proper operation. Contact Liebert Customer Service & Support if you require assistance.]
Equipment Over-Temperature	S	Sensors on power semiconductor heatsinks detect temperatures above the steady state limits for these components. The control logic sets off the alarm but does not shut down the UPS module if the condition lasts less than 10 minutes. [Check the air intake, air exhaust, and filters. Reduce the load or transfer it to bypass. Contact Liebert Customer Service & Support if the alarm persists.]
Over-Temperature Timeout	D, F	An Equipment Over-Temperature condition has persisted for more than 10 minutes. The load is transferred to the bypass line and the UPS module is shut down. [Check the air intake, air exhaust, and filters before attempting to start-up the UPS.]
<b>REMOTE MONITOR PANEL</b>		
Load On UPS	R	The UPS is operating properly. No corrective action is necessary.
New Alarm	R	Another new alarm message has been registered on the UPS system. [Clear the new alarm condition, if possible.]
Summary Alarm	R	One or more of the UPS alarm messages has been activated. Use the Present Status screen to determine which alarms are active. [Clear the new alarm condition, if possible to do so.]

**Table 1 Abbreviations**

D = auto-dial; L = latches

E = reports only; R = remote

F = freezes; S = summary

D\* = auto-dial initiated by Auto Transfer to Bypass if load is on UPS when alarm occurs

**Table 2 Alarm Messages - Summary**

Alarm Message	Special Functions
Input Fail	—
DC Ground Fault	L, S
DC Capacitor Fuse Blown	D, F, S
Battery CB Open	S
Battery Discharging	R, S
Low Battery Warning	R, S
Low Battery Shutdown	D, F, L, S
DC Over-Voltage Shutdown	D, F, L, S
Load on Bypass	R
Auto Transfer to Bypass	D, E, F
Auto Retransfer Primed	—
Manual Reset/Retransfer	—
Static Switch Unable	S
Bypass Not Available	—
Bypass Phase Sequence Wrong	—
Input Current Unbalanced	E
Control Power Fail	L, S
Output Over/Under Frequency	L, S
Output Under-Voltage	D, F, L, S
Output Over-Voltage	D, F, L, S
Overload	R, S
Overload Transfer	D, F, L, S
Overload Shutdown	D, F, L, S
Reverse Power	D, F, L, S
Rectifier Fuse Blown	D, F, S
Inverter Fuse Blown	D, F, S
Hardware Shutdown	D*
Emergency Off	D*, L, S
Inverter Non-Synchronized	—
Battery Cycle Buffer Warning	D, E
Ambient Over-Temperature	R, S
Blower Failed	S
Equipment Over-Temperature	S
Over-Temperature Timeout	D, F
Load On UPS	R
New Alarm	R
System Summary Alarm	R

D = auto-dial

E = reports only

F = freezes

L = latches

R = remote

S = summary

D\* = auto-dial initiated by Auto Transfer to Bypass if load is on UPS when alarm occurs.

---

### 3.1.14 Communication Interfaces

Your Liebert Series 600 UPS includes the following communication ports:

- Worldwide reporting to a remote terminal through a modem (optional on 150-375 kVA units)
- Reporting to a local terminal (no modem required)
- Reporting to a local monitor only
- Site reporting to Liebert SiteScan or Sitemaster central monitoring system (optional on 150-375 kVA units)
- Selected alarm messages to a Liebert Remote Monitor Panel and to contact closures for customer use.

All external communication devices, including the modem, are optional equipment. Connections to communication ports are made by wiring cables to terminal boards. Connection points, are shown on the Control Wiring Interconnect Diagram. Contact Liebert Customer Service and Support for assistance when attaching an external device to your UPS system.

Any terminal that accepts the standard 7-bit ASCII codes and conforms to the data link require meets can be used to interface with the Series 600 UPS. If a printer is used, the terminal must support it. The UPS does not send or receive any printer control commands.

Data link requirements are:

- Asynchronous RS-232 communication
- Terminals may be configured as DTE or DCE
- Baud Rate:
  - Modem: 300, 1200, 2400
  - Terminal: 2400 only
- Data Bits: 7
- Stop Bits: 1
- Parity: Odd
- Handshaking: Not required
- Full Duplex

#### Worldwide Reporting

This port transmits UPS system status and history information to a remote terminal in RS-232 format through a Hayes<sup>1</sup>-compatible modem.

#### Auto-Dial

The Series 600 UPS communication program will automatically dial a pre-programmed (customer selected) phone number when specified alarm conditions occur. The auto dial phone number, an alternate number, and the modem baud rate are programmed by using the System Configuration screen. The alarm messages that initiate an auto-dial call are identified in **Table 1**.

When the auto-dial function is initiated, automatic dial attempts to the first phone number are made at periodic intervals for 30 minutes. If unanswered, the system rolls over to the second number and repeats calling until connection is made or returns to first phone number after 30 minutes.

Once a connection is made to a terminal, the system transmits the information on the Present Status Report screen, then hangs up. The Present Status Report includes the UPS system identification number, date, time, alarm messages and metered parameter indications.

#### Requesting Information

If your Series 600 is equipped with a modem and telephone line, you can call the UPS and receive system status and historical information on discharge events. You can place the call from either a remote terminal or a personal computer with a communications program.

Follow the instructions for your terminal or your communications program to call the UPS. When you make connection, the UPS will send you the greeting: "Hello, you are connected to a Series

1. Hayes is a Registered Trademark of Hayes Microcomputer Products, Inc.

---

600.” At this point, the UPS will respond to your specific requests for information, according to **Table 3**.

For example, to see a copy of information on the Present Status Report screen (see **Present Status** in this manual), press the A key (either upper or lower case can be used for all except the date and time commands) and then the Enter key. The Series 600 will send the data, which will be displayed on your screen. Please note that the data on the screen is line a snapshot—the status of the UPS at the moment you requested the information. The information sent remotely is not updated, although you can repeat the process at intervals to request the present information.

Some screens, like the Battery Cycle Monitor information, contain data that you may wish to import into a spreadsheet for further calculations. To put this data into a usable format, use the screen-capture feature of your communications software (or a separate screen-capture program) to save all or part of the data to disk. Hint: If you save the file with an extension of ".txt," it can then be imported into a spreadsheet program and converted to worksheet format.

To terminate your connection to the Series 600, press the H key and then the Enter key. The UPS will hang Up its modem and await your next call.

### **Local Reporting to a Terminal**

This port sends UPS system status and history information to a local terminal in RS-232 format. No modem is required. The Present Status Report screen is sent to the local terminal whenever a new alarm occurs. Commands for requesting information, and for changing the date and time, are in **Table 3**.

### **Local Reporting to a Monitor**

A monitor connected to this port will display the same information being sent to the local terminal. This monitor does **not** display information going out through the modem port.

### **Site Reporting: SiteScan or SNMP**

The SiteScan port sends UPS system information to a Liebert SiteScan or Sitemaster central monitoring system. UPS operation, environmental control systems, and facility security can all be monitored from a single location.

If your site has SNMP communications, the optional Liebert SiteNet Integrator allows you to monitor the status of all the dry-contact outputs of the Series 600. The Integrator module monitors up to ten digital inputs and two temperature/humidity sensors, and can control two external devices with contact closure outputs. It can be programmed to activate local audible and visual alarms in addition to network “traps.”

### **Remote Monitor Panel**

The Liebert Remote Monitor Panel provides an LED indication of the following conditions:

- Load On UPS
- Load On Bypass
- Battery Discharge
- Low Battery Warning
- Overload
- Ambient Overtemp
- System Summary Alarm
- New Alarm

This information is also available for customer use through a set of contacts on a separate terminal board.

Alarm messages that activate the System Summary Alarm are listed in two tables (**Standard Remote Monitor Indications** and **Other Alarms That Activate System Summary Alarm**) in **3.1.5 - System Configuration Screens**.

The Remote Monitor Panel housing is a NEMA Type 1 enclosure, available for either surface mount or flush mount installations.

## Separate / Simultaneous Outputs

Each of the communication interfaces previously described has its own dedicated port for connection to the required external device. Therefore, you can use any or all of the communication functions built into the Series 600 UPS. Note that whatever interfaces you use will all operate simultaneously.

**Table 3 Series 600 Terminal Commands**

Key(s)	Function
A, return	Displays Present Status Report screen.
^B (control-B), return	Displays Event History Report screen, starting with the most recent frame and then scrolling back through earlier frames.
C, return	Displays History Status Report screen starting with the most recent frame and then scrolling back through the earlier frames.
F (no return)	Freezes data output. This stops the data scrolling on the monitor to allow closer study or a printout. This is a toggle switch command. Press the F key again to resume data scrolling.
G, return	Resets (unfreezes and clears) the History Status Report memory buffer. This erases the alarm messages and meter indications that were stored immediately before and after a significant system fault.  <b>NOTE:</b> <i>Do not reset the History Status Report memory buffer until operation and maintenance personnel have reviewed it as a troubleshooting tool.</i>
Q (no return)	The data output stops (quits). The UPS communication system remains on stand-by, ready to receive the next communication command.  <b>NOTE:</b> <i>To return to the beginning of the Event History or History Status Report, press <b>Q</b>, then request your desired report again.</i>
d mm/dd/yy, return	This entry sets the date (month/day/year) in the UPS system clock. You must include the slash (/) as you key in the date. Note that the <b>d</b> command must be lower case.
t hh:mm:ss, return	This entry sets the time (hour: minute:second) in the UPS system clock. You must include the colon (:) as you key in the time. Note that the <b>t</b> command must be lower case.
H, return	Prompts the UPS system to hang up its modem (only applicable to the modem communications port).
I, return	Display Battery Cycle Monitor information for 0-30 Second Discharge Events.
J, return	Display Battery Cycle Monitor information for 31-90 Second Discharge Events.
K, return	Display Battery Cycle Monitor information for 91-240 Second Discharge Events.
L, return	Display Battery Cycle Monitor information for Over 240 Second Discharge Events.
M, return	Display Status Summary screen of battery discharge events.
N, return	Show detail information on all battery discharge events in order of occurrence (Last-In, First-Out).
backspace	Moves cursor left to cancel previous entry or command.

### 3.2 Modes of Operation

This section illustrates the flow of power through circuit breakers, switches, and UPS components during various modes of operation of the Liebert Series 600 UPS. Highlighted (thick) lines in the diagrams indicate power flow and power availability.

These illustrations show a three breaker maintenance bypass because it is most commonly used. Your installation may have a two breaker or three breaker maintenance bypass, or none at all.

These illustrations do not show an alternate power source (generator) and automatic transfer switch (external to the UPS) that might be present at your installation.

The following circuit breaker abbreviations are used:

BFB	Bypass Feeder Breaker
BIB	Bypass Input Breaker
MBB	Maintenance Bypass Breaker
MBD	Module Battery Disconnect
MIB	Maintenance Isolation Breaker
RIB	Rectifier Input Breaker

#### 3.2.1 Load on Bypass

Load on Bypass, with the UPS not available, is shown in **Figure 42**. The UPS could be in this mode of operation during either initial start-up or UPS module shutdown and isolation for maintenance.

**Figure 42 Load on Bypass (UPS Not Available)**

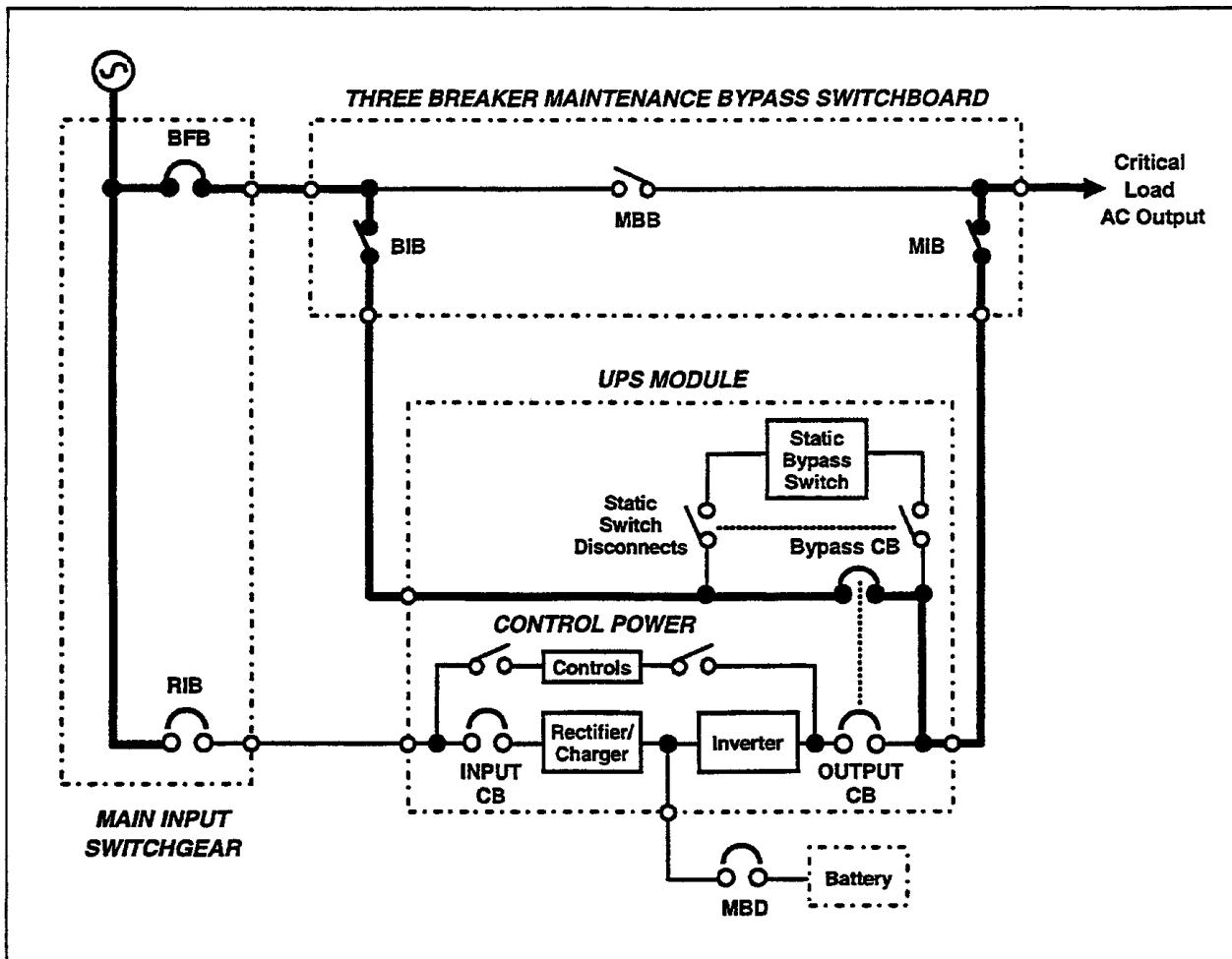



### 3.2.2 Ok To Transfer

The Ok to transfer status message will be displayed when the bypass line and UPS output power are both available, their voltage, frequency, and phase synchronization are matched within specifications, and the Static Switch Disconnect is closed (ON). An alarm message may be displayed to indicate Load On Bypass. If no alarm is displayed, the operating status is Load On UPS.

When the Ok to Transfer message is displayed, you can perform a manual transfer of the load from the UPS to bypass, or a manual retransfer of the load from bypass to the UPS.

Use the Load Transfer Procedures screen when performing a manual transfer. Refer to 3.3.2 - Load Transfer Procedures.

The UPS system control logic will initiate an automatic transfer to bypass if an overload condition exceeds the current versus time window, or if a UPS fault is detected. An automatic retransfer to the UPS may be initiated when recovering from overloads lasting less than five minutes. Refer to 3.4 - Automatic Operations.



#### NOTE

*When the critical load is being supplied power from the bypass line, it is exposed to utility power disturbances.*

Figure 43 Load on Bypass (UPS Available)

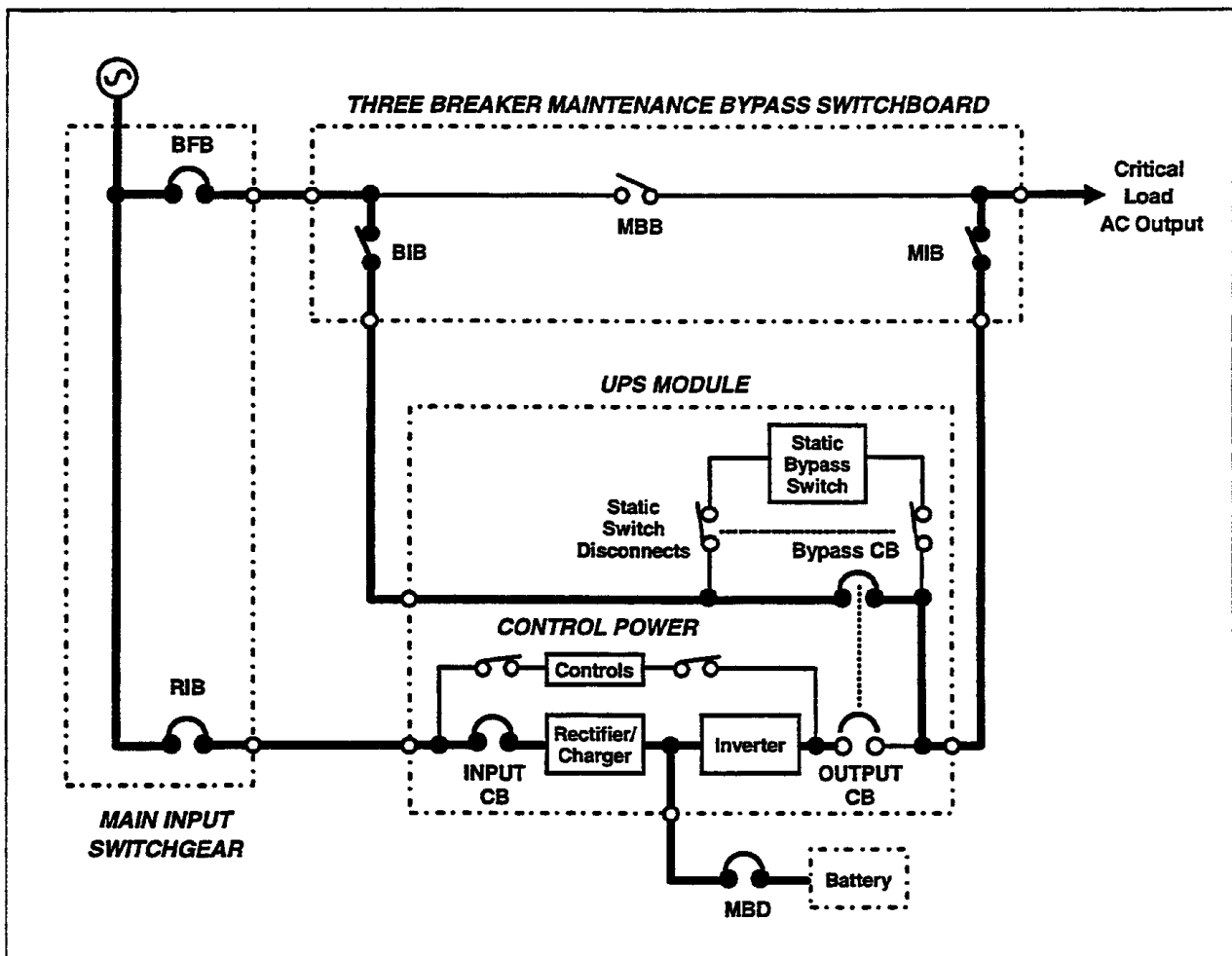
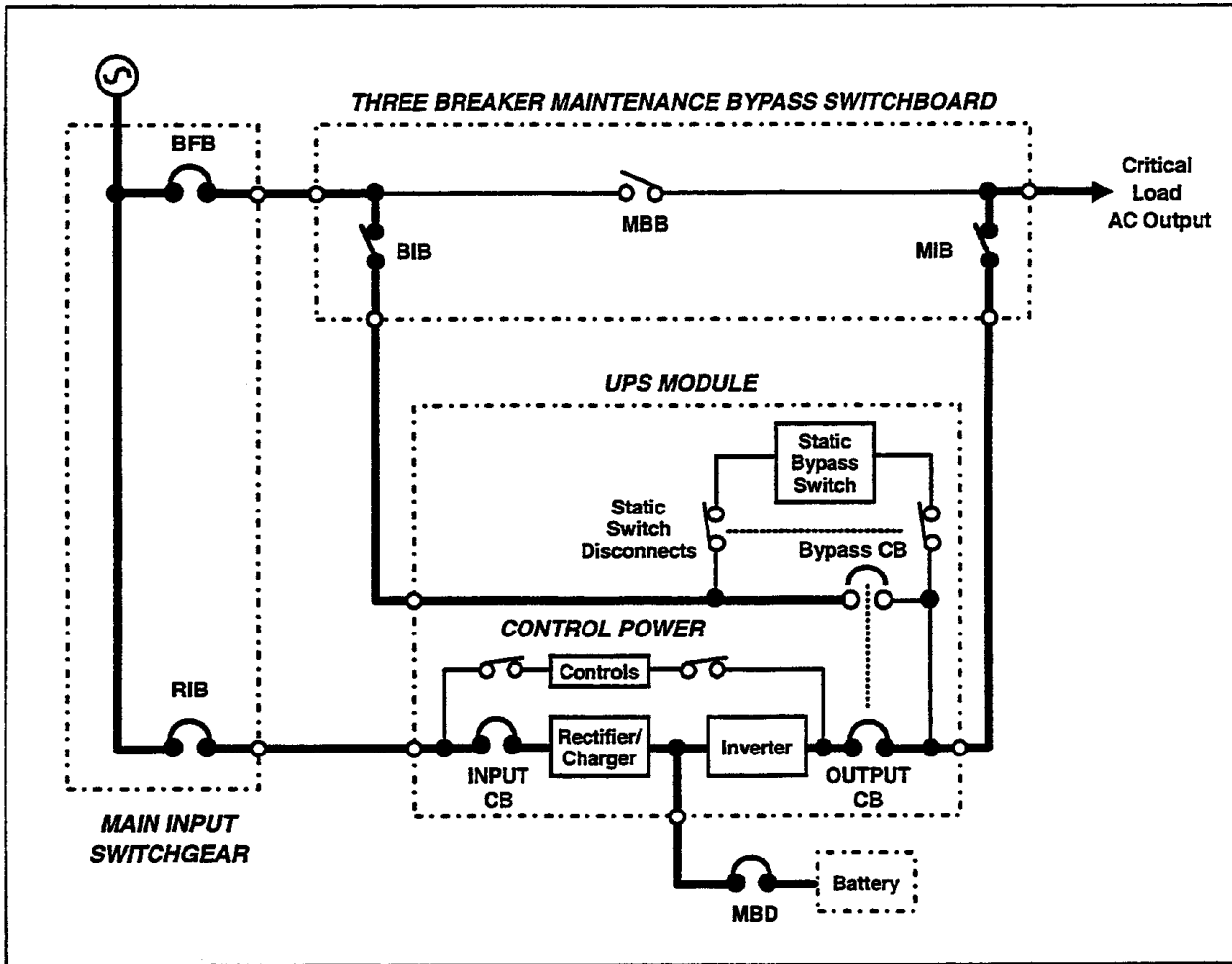

Figure 44 Load on UPS (Bypass Available)



### 3.2.3 Momentary Overloads

An overload in the critical load will continue to be supplied by the UPS module if the overload condition does not exceed the current versus time curve. The overload curve includes 150% of rated current for 30 seconds, 125% for 10 minutes, and 104% continuously.

Momentary overloads from 155% to 1000% of rated current can be supplied by pulsing the solid state static bypass switch for 40 milliseconds. This provides current from the bypass line in parallel with current from the UPS module inverter. By providing two power sources simultaneously, high current can be supplied to the critical load with full output voltage regulation. The critical load can be sustained through inrush currents and momentary faults without operating motorized circuit breakers.

If an overload situation exceeds 40 milliseconds, the UPS module continues to supply power to the critical load if it remains within the current versus time curve of overload capacity. If the overload capacity is exceeded, the UPS control logic initiates an automatic transfer to the bypass line by operating the static bypass switch and the motorized circuit breakers (output and bypass).

Refer to 3.4 - Automatic Operations.

Figure 45 Momentary Overload (Through Static Bypass Switch)

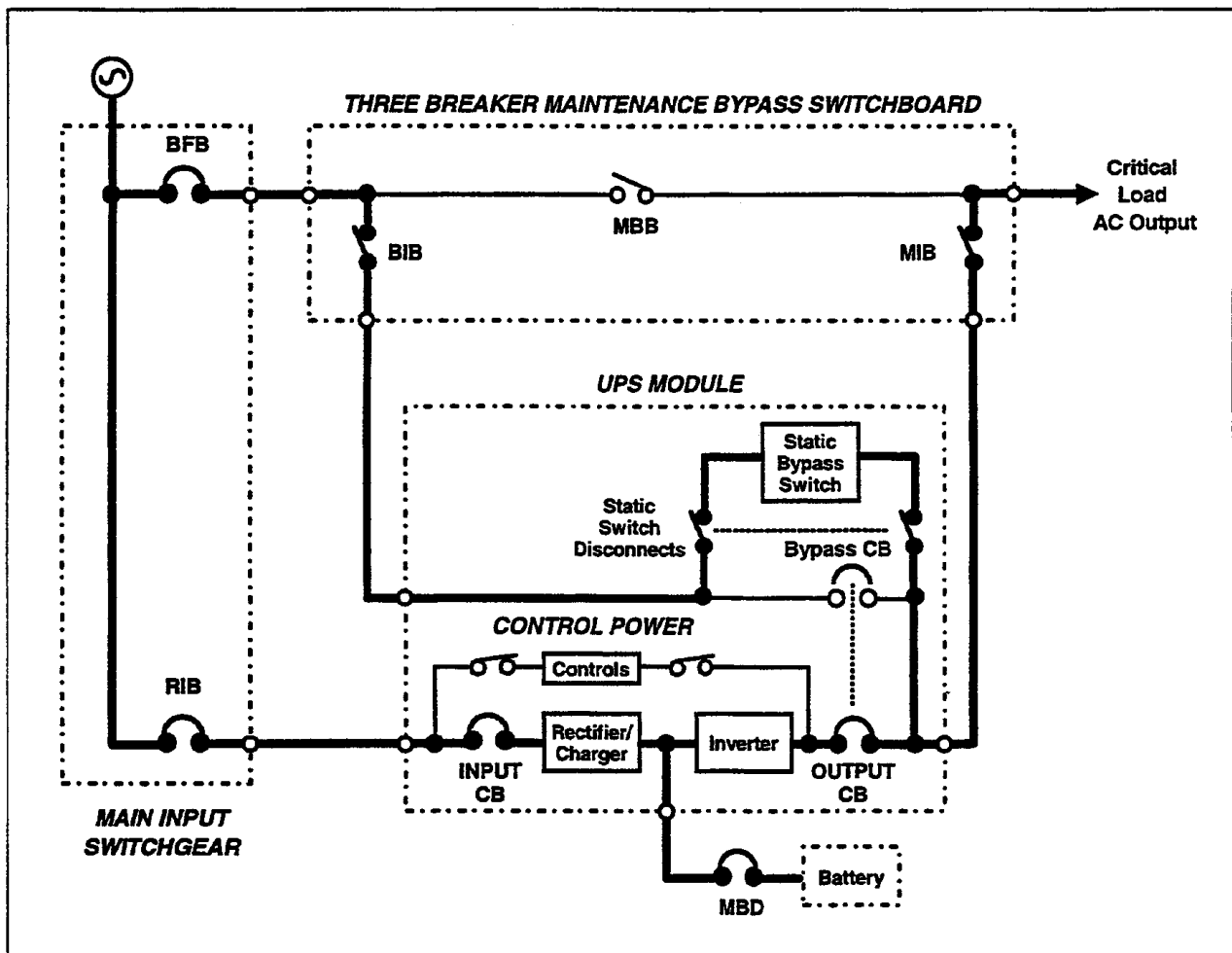

### 3.2.4 Input Power Failure (Load on Battery)

If the utility AC power source fails, or is outside the acceptable range, the battery plant becomes the power source for the UPS module inverter. The inverter continues to supply power to the critical load, and also to the UPS controls.

You can use the Battery Time screen to monitor the present battery voltage compared to the shut-down value. The length of time the battery can sustain the load depends on the size of the load and the size and condition of the battery plant. The battery plant is usually large enough to supply a 100% rated load for 15 minutes.

Alarm messages that indicate battery status are Battery Discharge, Low Battery, and Battery Shutdown. The voltage limits for these alarms are displayed on the Alarm Limit Settings screen. These limits were selected for your installation by Liebert Customer Service and Support during initial start-up.

The battery block in the Monitor/Mimic Display indicates Charge or Discharge and the current in Amperes. Maximum battery discharge current ranges from 316 amps (for 150 kVA) to 2440 amps (for 1000 kVA). Refer to the separate **Installation Manual** or drawings for specific data on your system.

Figure 46 Input Power Fail (Load on Battery)

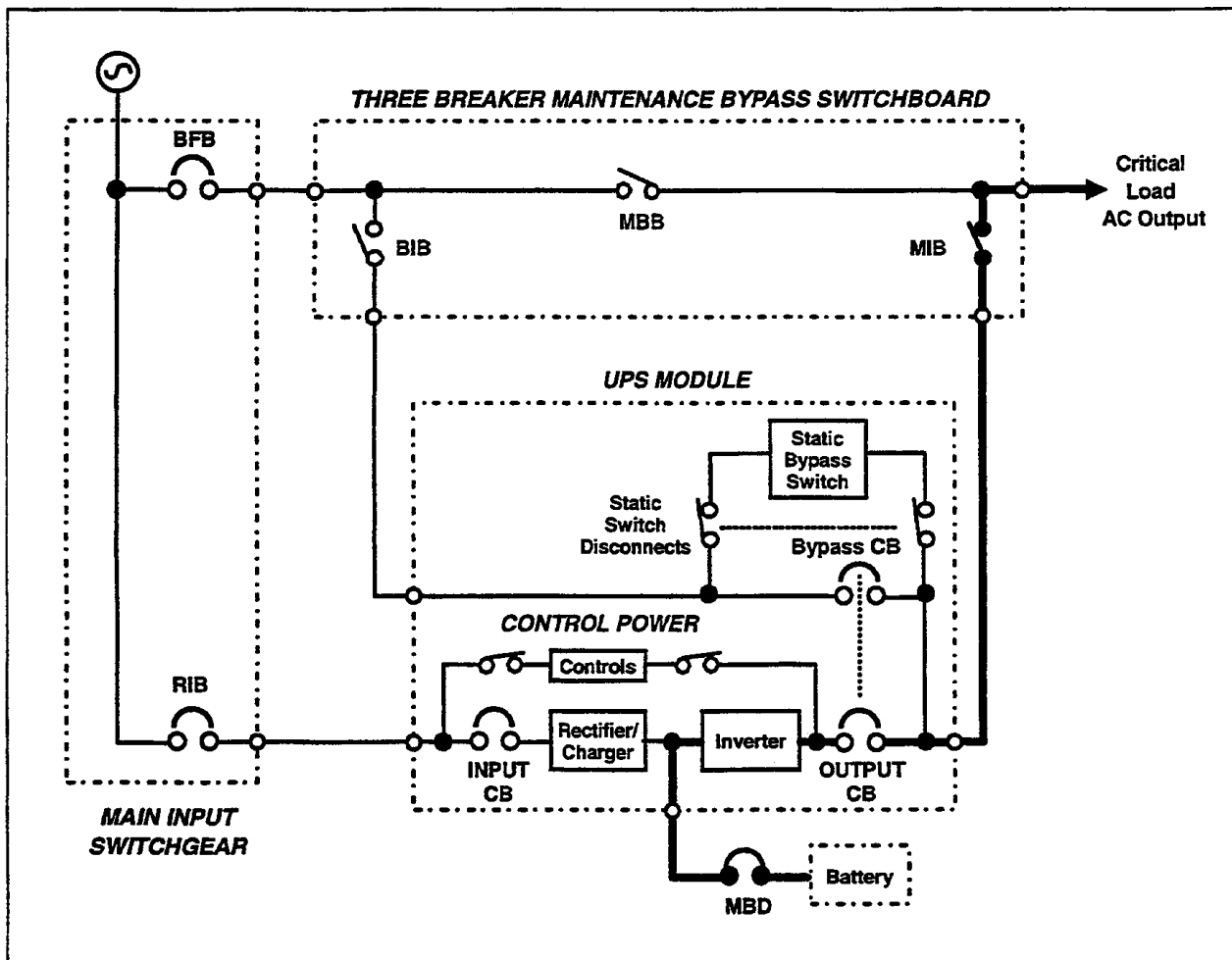

### 3.2.5 Off Battery

The battery plant can be disconnected from the UPS, if required for battery maintenance, by opening the module battery disconnect (MBD) circuit breaker. In this situation the UPS module will continue to supply conditioned power to the critical load, but if input power fails, the UPS **cannot** supply power to the load.



#### CAUTION

When the UPS is operating with the module battery disconnect (MBD) circuit breaker open, the critical load is not protected from loss of the utility source power.

Figure 47 Load on UPS (Battery not Available)

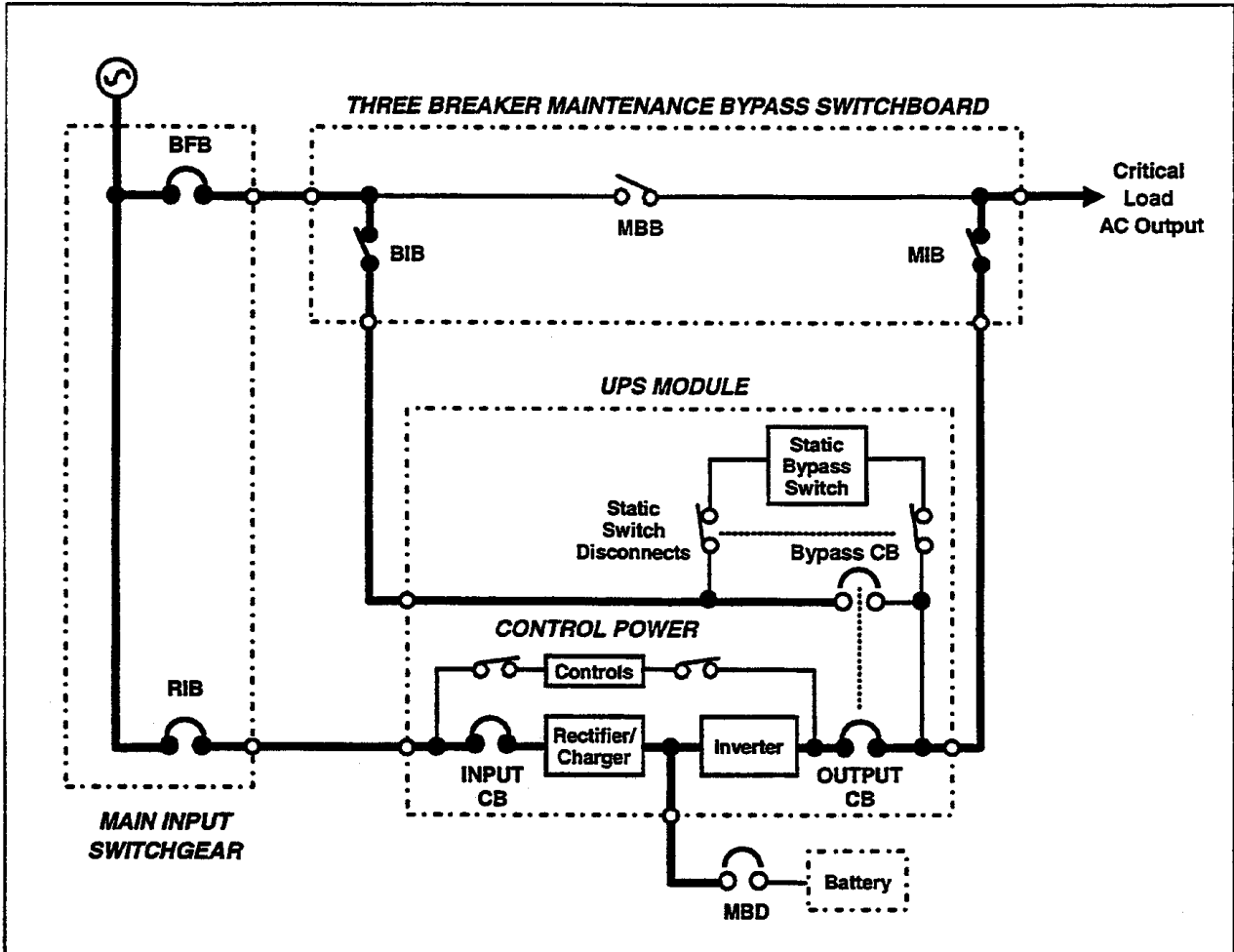

### 3.2.6 Local Emergency Module Off (LEMO)

The Local Emergency Module Off (LEMO) mode is used to remove power from all UPS module components, and the critical load will continue to be supplied through the bypass line.

The **Emergency Module Off** control is a guarded pad on the UPS Control Panel (**Figure 10**).

Lift the cover and press the pad. The load will be transferred to bypass, and the battery (MBD) and input circuit breakers will be opened (tripped). This will remove power from all UPS module components except the controls, bypass circuit breaker, and the static switch.

Refer to 3.3.3 - Shutdown Procedures.

Figure 48 Local Emergency Module Off (LEMO)

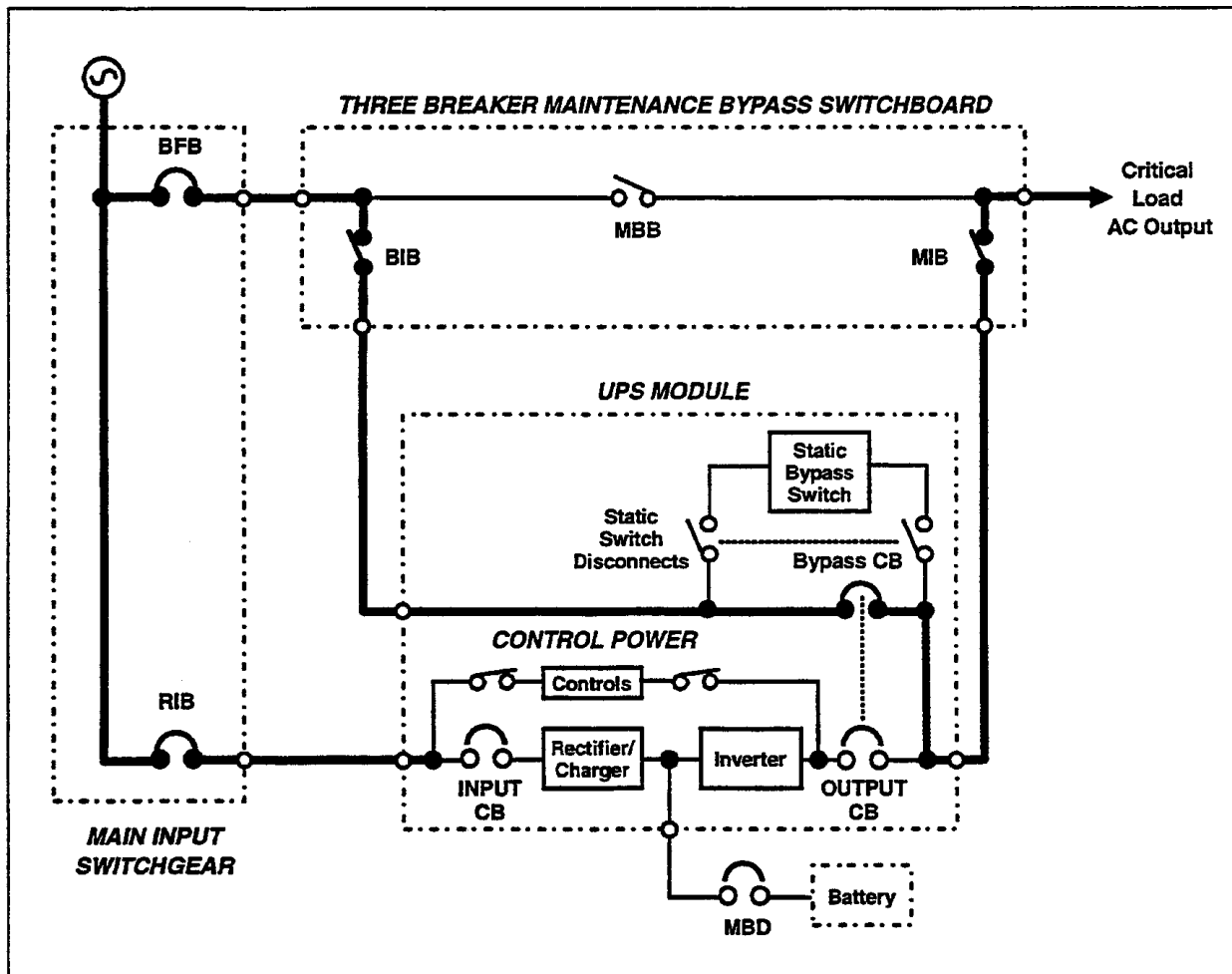

### 3.2.7 Remote Emergency Power Off (REPO)

The Remote Emergency Power Off (REPO) mode is used to remove all power from the critical load.

The Remote Emergency Power Off control is a switch located remotely from the UPS module. It will normally be in the same room as the critical load equipment. This mode can also be initiated by an automatic contact closure in the same external circuit as the manually operated switch.

When you operate the **Emergency Power Off** switch, all UPS circuit breakers are opened including the bypass circuit breaker. All power through the UPS is removed from the load. Typically, the REPO circuit also opens the circuit breakers that provide power to the bypass lines and the UPS controls.



#### NOTE

*REPO can also be configured for total power shutdown to load.*

Refer to 3.3.3 - Shutdown Procedures.

Figure 49 Remote Emergency Power Off (REMO)

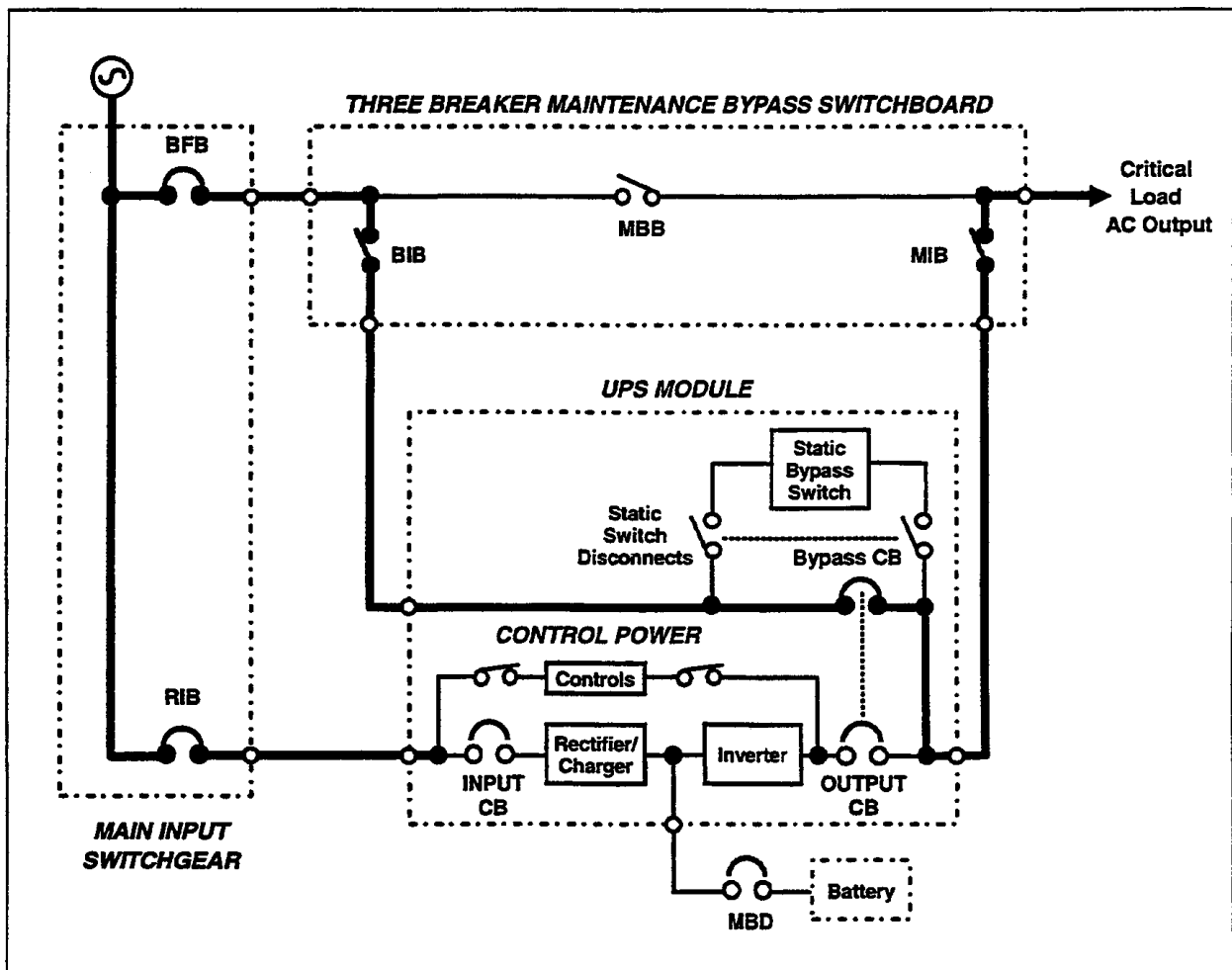

### 3.2.8 Module Shutdown

Perform a Module Shutdown procedure when you must disconnect the UPS module components and the UPS cabinet from all power sources when required for maintenance procedures.

Use the Shutdown Procedures screen when performing a manual Module Shutdown.

Refer to 3.3.3 - Shutdown Procedures.

Refer to 3.2.9 - Maintenance Bypass.

Before performing any maintenance on your Liebert Series 600 UPS, observe ALL of the WARNINGS in 4.0 - Maintenance.



#### WARNING

**LETHAL VOLTAGES ARE PRESENT WITHIN THIS UNIT EVEN WHEN IT IS NOT ON OR WHEN POWER IS NOT BEING SUPPLIED. OBSERVE ALL CAUTIONS AND WARNINGS IN THIS MANUAL. FAILURE TO DO SO COULD RESULT IN SERIOUS INJURY OR DEATH. DO NOT WORK ON OR OPERATE THIS EQUIPMENT UNLESS YOU ARE FULLY QUALIFIED TO DO SO!! NEVER WORK ALONE.**

Figure 50 Module Shutdown

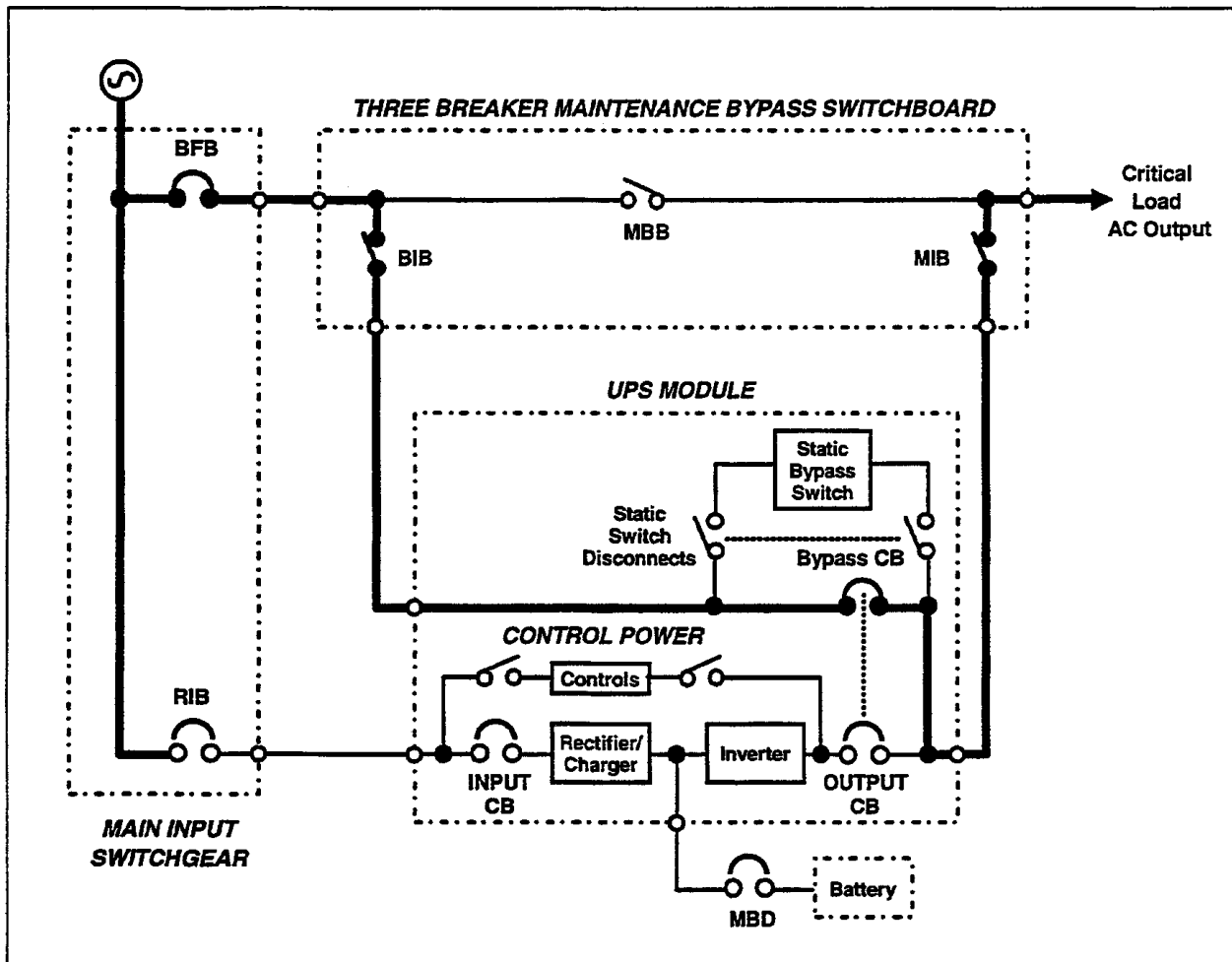



### 3.2.9 Maintenance Bypass

Maintenance Bypass switchgear allows you to totally isolate the UPS from all power sources, while you maintain power to the critical load.

Your installation may have a Two Breaker or Three Breaker Maintenance Bypass, or none at all. The main difference between a Two Breaker and Three Breaker Maintenance Bypass is the location of the Bypass Input Breaker (BIB).

Another option that may be present at your site is an alternate power source (generator) and an automatic transfer switch (ATS).

Note that to totally isolate the UPS from all power sources, the Main Input switchgear and battery circuit breakers must also be opened.



#### CAUTION

Instructions for operating the Maintenance Bypass circuit breakers are on the Maintenance Bypass cabinet. Make sure you understand the proper sequence before operating any circuit breaker. Operating a Maintenance Bypass circuit breaker out of sequence could cut off power to the critical load.

Figure 51 Load on Maintenance Bypass (Two Breakers)

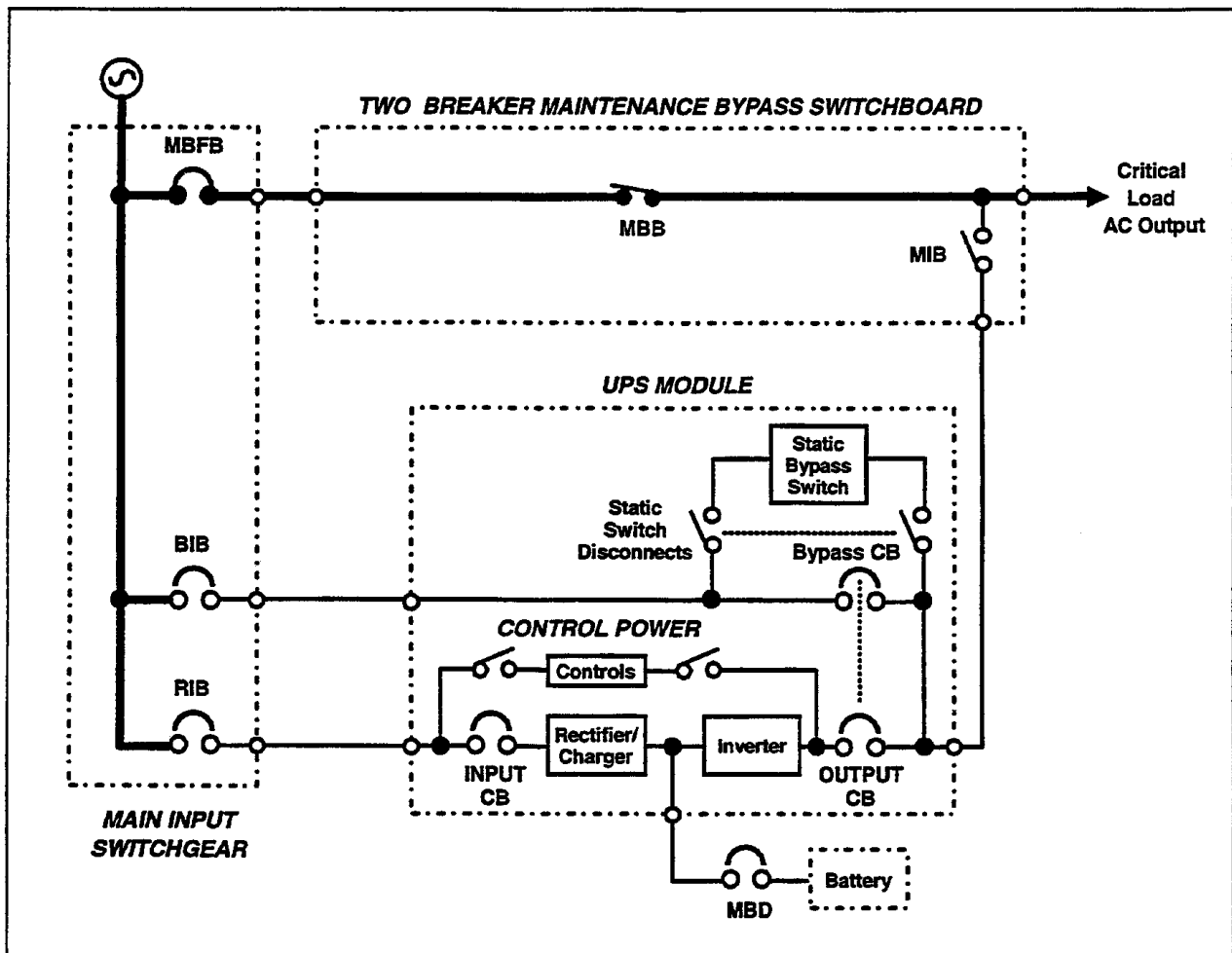



---

### 3.3 Manual Procedures

The Liebert Series 600 UPS is designed to function while unattended by an operator. The system control logic monitors the performance of the UPS, the availability of power sources, and the current required by the critical load.

The system control logic:

1. Determines what overload conditions can be sustained without a transfer to bypass.
2. Initiates an automatic transfer to bypass to sustain an overload, or when selected UPS faults occur.
3. Can initiate an automatic retransfer to the UPS after an overload has been cleared.
4. Initiates an automatic transfer to bypass and emergency module shutdown when selected UPS faults occur.

Refer to **3.4 - Automatic Operations** for more details.

Manual procedures available to the operator include Start-Up, Load Transfers, and Shutdowns. These procedures are performed by using the operator control panel and some manually operated circuit breakers and switches.

The LCD display includes a screen to help you with each manual procedure by listing each step you must perform.

This section lists step-by-step controls to operate and conditions to observe in the following manual procedures:

1. Start-Up: including initial start up, recovering from input power failure, recovering from battery shutdown, and recovering from shutdowns for emergencies or maintenance procedures.
2. Load Transfers: including transfers from UPS to bypass, and retransfers from bypass to the UPS.
3. Shutdowns: including module shutdowns for maintenance procedures and emergency shutdowns.

---

### 3.3.1 Start-Up Procedures

When the UPS module has been shutdown, for any reason, use this procedure to start-up the UPS module to provide filtered, reliable power to the critical load. This procedure gives step-by-step instructions for controls to operate and conditions to observe. Your present situation could be initial start-up or recovering from input power failure, battery shutdown, maintenance shutdown, or an emergency shutdown.



#### NOTE

*The following procedure assumes that the UPS installation inspection and initial start-up have been performed by Liebert Customer Service. A Liebert authorized representative must perform the initial system start-up to ensure proper system operation.*



#### CAUTION

**The following procedure provides power to the critical load distribution system. Verify that the critical load distribution is ready to accept power. Make sure that personnel and equipment are ready for the critical load distribution system to be energized.**

If your installation includes a Maintenance Bypass, you may already be supplying power to the critical load equipment through the Maintenance Bypass. If there is no power to the critical load, apply power through the UPS bypass line per the following procedure.

During a start-up procedure, power is supplied to the critical load through the UPS (internal) bypass line while the UPS module is being energized. Depending on the reason for your UPS module shutdown, you may already have power through the bypass line. You can determine this by observing the Monitor/Mimic Display screen after Control Power is available.

**Step 1.** Before you apply power to the UPS module, determine the position of the following circuit breakers and switches:

- Rectifier Input Breaker (RIB) - If this external circuit breaker is closed, you already have power to the UPS cabinet and possibly power to the controls. If this breaker is closed, leave it closed. If it is open, leave it open until you are ready to apply power to the UPS cabinet.
- Bypass Input Breaker (BIB) - If this external circuit breaker is closed, you may already have power to the critical load through the bypass line. If this breaker is closed, leave it closed. If it is open, leave it open until you are ready to energize the bypass line.
- Input Circuit Breaker - Verify that this breaker on the front of the UPS cabinet (**Figure 7** and **Figure 8**) is in the OFF position.
- Module Battery Disconnect (MBD) - Verify that this external breaker is open or tripped.
- Bypass Circuit Breaker - This motorized circuit breaker (**Figure 7** and **Figure 8**) should be closed unless you are recovering from an Emergency Power Off. You may already be supplying power to the critical load through this breaker. If this breaker is open, you will be instructed to reset it after Control Power is available.
- Output Circuit Breaker - This motorized circuit breaker (**Figure 7** and **Figure 8**) should be open.
- Static Switch Disconnects - These manually operated switches (**Figure 7** and **Figure 8**) will be in the ON (closed) position unless you are recovering from a shutdown. If these switches are OFF (open), you will be instructed to reset them and turn them to ON later in this procedure.
- Control Power - This manually operated switch (**Figure 7** and **Figure 8**) will be in the ON position unless you are recovering from a maintenance shutdown. If this switch is OFF, leave it OFF until you are ready to apply power to the UPS controls.



#### CAUTION

**If you are recovering from a module shutdown for maintenance procedures, verify that all of the UPS system doors are closed and latched. All test equipment must be removed from the system. All electrical connections must be secure.**

---

**Step 2.** Power must be provided to the UPS controls so the operator can use the LCD display and so the system logic can perform its control functions. Note that you can use the LCD display to monitor UPS status, even when the UPS module is not operating. If the LCD display is operating, you already have Control Power. This will be the usual condition, unless you are recovering from a maintenance shutdown.

If the LCD screen is not operating, energize Control Power by operating the following two controls:

- a. Close the Rectifier Input Breaker (RIB), which is outside the UPS cabinet. This will provide power to the UPS cabinet but not to any UPS components.
- b. Open the UPS cabinet door and turn the **Control Power** switch ON. (See **Figure 7** and **Figure 8**.) Close the UPS cabinet door.



**NOTE**

*Wait two minutes after applying Control Power before you operate any other UPS controls.*

**Step 3.** During a start-up procedure, power is supplied to the critical load through the (internal) bypass line while the UPS module is being energized. Depending on the reason for your UPS module shutdown, you may already have power through the bypass line. You can determine this by observing the Monitor/Mimic Display screen now that Control Power is available.

If the bypass line is not supplying the load, energize the bypass line by operating the following controls:

- a. Close the Bypass Input Breaker (BIB), external to the UPS. This breaker may be in your Maintenance Bypass cabinet.



**CAUTION**

**DO NOT assume that the UPS Bypass breaker is closed.**

**Instructions for operating the Maintenance Bypass circuit breakers are on the Maintenance Bypass cabinet. Make sure you understand the proper sequence before operating any circuit breaker. Operating a Maintenance Bypass circuit breaker out of sequence could cut off power to the critical load.**

- b. Observe the Monitor/Mimic Display screen to determine if your UPS Bypass circuit breaker is closed and whether the UPS Bypass line is supplying power to the critical load. If your Bypass circuit breaker is open (as in recovering from an Emergency Power Off or Low Battery Shutdown), close this circuit breaker as follows:
  - b1. Open the control panel door and find the Transfer Relay Board (**Figure 9**). If the red LED (CR18) labeled TOT S/D (Total Shutdown) is on, press the **Bypass Reset** switch (SW1) on this board. The red LED should turn off.
  - b2. Set the **Static Switch Disconnects** (**Figure 7** and **Figure 8**) to OFF (open). On 150 to 375 kVA T-UPS, this function is handled automatically.
  - b3. Find the **Close B.P.** (bypass) jumper on the Logic Board (**Figure 9**). Remove and replace jumper to reset the Bypass circuit breaker. Check the Monitor/Mimic screen to verify the breaker is closed.
  - b4. Locate the two Static Switch Monitor circuit boards, behind door below the control panel (**Figure 9**). On each board, the green LED (DS5) when on indicates Control Power is available and the static switch and monitor circuits are functioning properly. The red LED (DS4) when on indicates the monitor circuit needs to be reset. Press the **Reset Switch** (SW1) on each board. The red LED should turn off.
  - b5. On 500 to 1000 kVA models, set the Static Switch Disconnects to ON (closed). On some 150 to 375 kVA T-UPS models, this function is handled automatically.
  - b6. Close the UPS module doors.

- 
- c. If the UPS Bypass line is available, but not yet supplying power to the load, close the circuit breakers (external to the UPS) required to provide power to the critical load equipment. If you have a Maintenance Bypass, this will include the Maintenance Isolation Breaker (MIB).



**CAUTION**

**Make sure you understand the proper sequence before operating any circuit breaker. Operating a Maintenance Bypass circuit breaker out of sequence could cut off power to the critical load.**

- c1. Verify the Bypass Input Breaker (BIB) and UPS Bypass circuit breakers are closed.  
c2. Close the Maintenance Isolation Breaker (MIB).  
c3. Open the Maintenance Bypass Breaker (MBB).

Observe the Monitor/Mimic Display screen to confirm that the UPS Bypass line is energized and supplying power to the critical load equipment.

**Figure 53 Optional Maintenance Bypass Cabinet for 150 and 225 kVA**

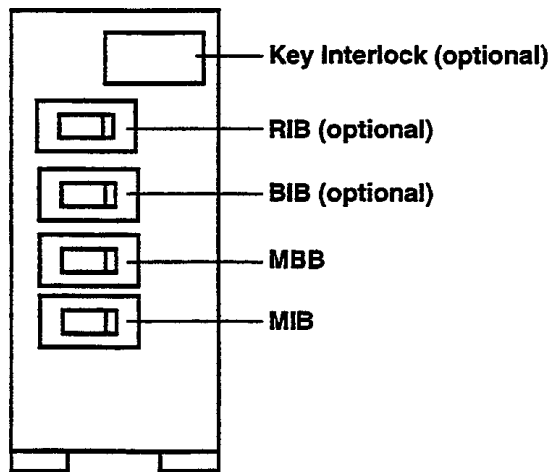
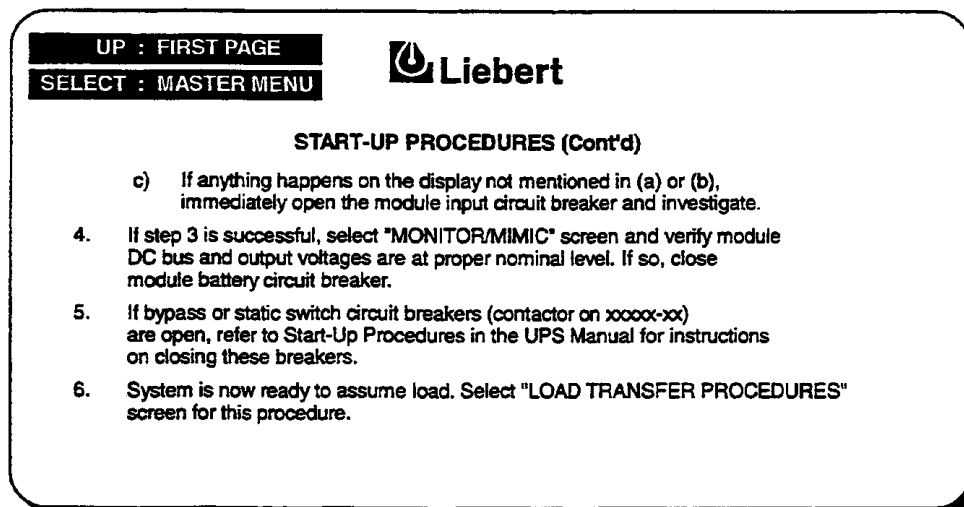
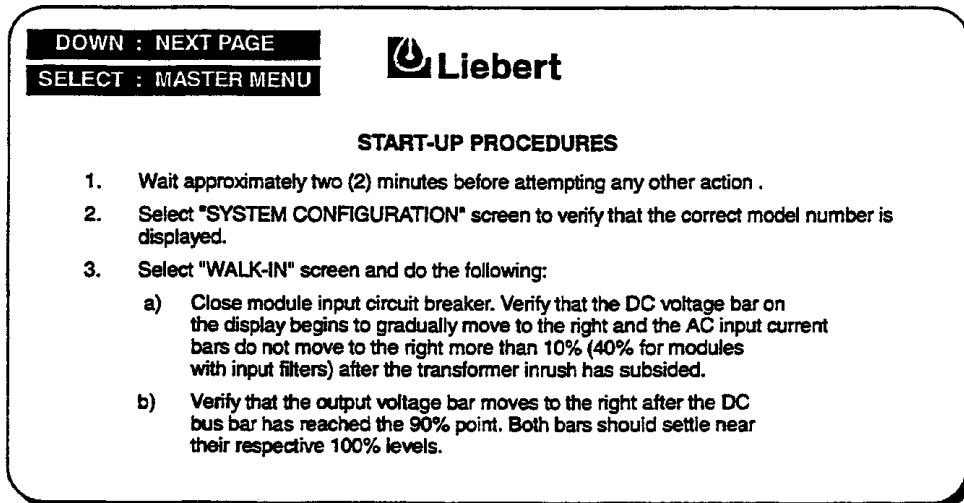

Figure 54 Start-Up Procedures Screen



**Step 4.**

- a. Press the **Select** pad to put the Master Menu on the LCD display. Move the highlighted cursor to Start-Up Procedures (use the **Up** and **Down** pads). Press the Select pad to display the Start-Up Procedures screen. Return to this screen whenever you need to see the start-up instructions.
- b. On the LCD display, select **System Configuration** from the Master Menu. Verify that all of the information contained in the System Configuration screen is correct. When the data is correct, press the Select pad until the display returns to the Master Menu.
- c. Select the **Walk-In** screen on the LCD display.

To energize the UPS module, close the input circuit breaker (**Figure 7** and **Figure 8**). This will provide power to the rectifier. Use the Walk-In screen to monitor the Module DC Bus voltage.



**WARNING**

**IF ANY ABNORMAL SITUATION OCCURS DURING THIS WALK-IN PROCEDURE, OPEN THE INPUT CIRCUIT BREAKER AND INVESTIGATE THE PROBLEM. EACH INPUT AMPS BAR SHOULD BE WITHIN 10% OF THE AVERAGE BAR LENGTH. CALL LIEBERT CUSTOMER SERVICE AND SUPPORT IF YOU NEED HELP.**

---

The Input Amps bars should settle at about 10% after the momentary inrush current has subsided.

Verify that the DC Voltage bar begins to gradually move to the right.

Verify that the Output Voltage bar moves to the right after the DC Voltage bar has reached the 90% level. Both bars should settle near the 100% line.

Select the **Monitor/Mimic** display from the Master Menu and confirm that the module DC bus and AC output are at their proper operating voltages.

**Step 5.** When the Module DC Bus voltage is at 100%, you can manually close the module battery disconnect (MBD) circuit breaker (external to the UPS).

The Battery block in the Monitor/Mimic Display indicates the battery voltage and charge current.



#### NOTE

*The battery charge current may increase quickly, but then should slowly decrease. A fully charged battery will require no more than 31 Amps of charge current.*

*If you are recovering from a battery shutdown or an input power failure, the UPS rectifier will be recharging the battery. Recharge current can be more than 100 Amps. The maximum allowable recharge current for your unit will depend on the kVA rating and your factory-set battery recharge current limit.*



#### CAUTION

**Do not use the Battery Equalize Mode with sealed-cell batteries. Refer to the Battery Equalize screen and your battery manufacturer's manual.**

Use the Monitor/Mimic Display screen to determine the condition of the UPS module. Press the **Alarm Reset** pad to clear the Alarm Messages. Refer to **Table 1** for an explanation of any remaining alarm messages (except Load On Bypass). Call Liebert Customer Service and Support if you cannot clear the remaining alarm messages.

If the only alarm message displayed is Load On Bypass, the UPS module is now ready to provide filtered, uninterruptible power to the critical load equipment. Refer to **3.3.2 - Load Transfer Procedures** to retransfer the load from the bypass line to the UPS module.



### 3.3.2 Load Transfer Procedures

Use the Monitor/Mimic Display to determine the operating condition of the UPS module. Press the **Alarm Reset** pad to clear the Alarm Messages. Refer to **Table 1** for an explanation of any remaining alarm messages (except Load On Bypass). Call Liebert Customer Service and Support if you cannot clear the remaining alarm messages.

If the only alarm message displayed is Load On Bypass (or no alarms), you can perform a manual transfer of the load between the UPS module and the UPS bypass line. Changing the load from the UPS module to the UPS bypass is called a transfer. Changing the load from UPS bypass to the UPS module is called a retransfer. Note that the UPS system control logic can initiate automatic load transfers and retransfers. Refer to **3.4 - Automatic Operations**.

#### Step 1.

- a. Press the **Select** pad to display the Master Menu on the LCD display. Move the highlighted cursor to Load Transfer Procedures (using the **Up** and **Down** pads). Press the **Select** pad to display the Load Transfer Procedures screen.
- b. Verify that the **OK TO TRANSFER** message is highlighted. If not (if the **TRANSFER PROHIBIT** message is highlighted instead), slowly rotate the **Voltage Adjust** knob (**Figure 10**, item 6) to match the UPS voltage to the bypass voltage.



#### NOTE

*If the TRANSFER PROHIBIT message remains, refer to **Table 1** for corrective action for any alarm messages. Call Liebert Customer Service and Support if you cannot solve the problem.*

**Figure 55 Load Transfer Procedures Screen**

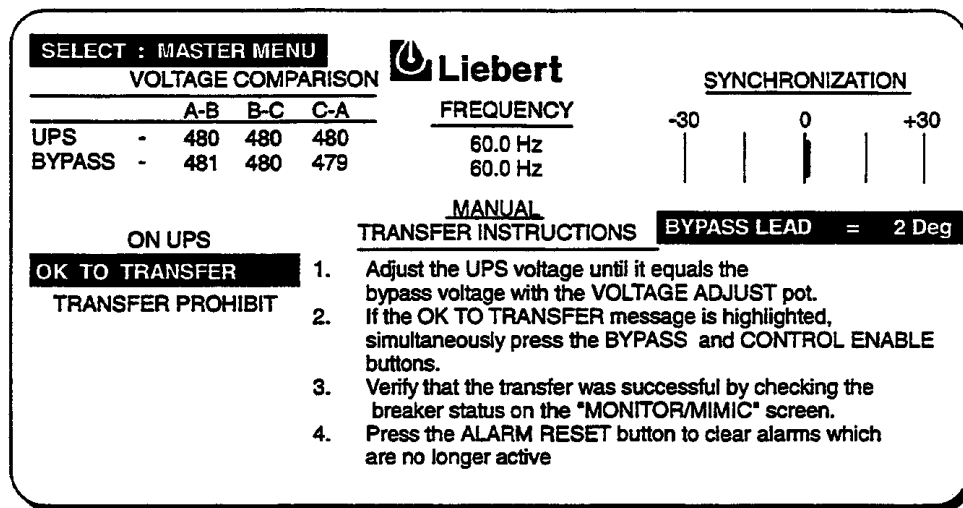

**Step 2.** Perform Step 2 on the Load Transfer Procedures Screen.

- a. **If the load is on the UPS module**, simultaneously press the **Bypass** and **Control Enable** pads (**Figure 10**). This will close the motorized bypass circuit breaker and open the UPS module output motorized circuit breaker in a make before break (MBB) sequence. Circuit breaker Overlap Time will be displayed on the screen.
- b. **If the load is on the UPS bypass**, simultaneously press the **UPS** and **Control Enable** pads (**Figure 10**). This will close the UPS module output motorized circuit breaker and open the bypass motorized circuit breaker in a make before break (MBB) sequence. Circuit breaker Overlap Time will be displayed on the screen.

Return to the Monitor/Mimic Display screen to monitor the operation of the UPS module. Press the **Alarm Reset** pad to clear any latched alarm messages removed by the new load status. Refer to **Table 1** if an alarm message other than Load On Bypass is still displayed. Contact Liebert Customer Service and Support if you require assistance.

---

## Maintenance Bypass Load Transfers

To manually transfer the load between Maintenance Bypass and the UPS bypass line, carefully follow these instructions. Do not transfer the load between Maintenance Bypass and the UPS module (inverter) output. Use the Monitor/Mimic Display screen to verify the UPS bypass line is available.



### CAUTION

**Make sure you understand the proper sequence before operating any circuit breaker. Operating a Maintenance Bypass circuit breaker out of sequence could cut off power to the critical load.**

#### Step 1. If the load is on the UPS Bypass:

- a. Close the Maintenance Bypass Breaker (MBB).
- b. Open the Maintenance Isolation Breaker (MIB). Load is now on Maintenance Bypass.
- c. If UPS bypass shutdown is required, open the Bypass Input Breaker (BIB).

#### Step 2. If the load is on Maintenance Bypass:

- a. Close the Bypass Input Breaker (BIB) or verify BIB is closed. Note that UPS Bypass circuit breaker (motorized) must also be closed.
- b. Close the Maintenance Isolation Breaker (MIB).
- c. Open the Maintenance Bypass Breaker (MBB). Load is now on UPS bypass.

### 3.3.3 Shutdown Procedures

#### Module Shutdown Procedures

Perform a Module Shutdown Procedure when you want to remove power from the UPS module and the UPS cabinet when required for maintenance.

Before performing any maintenance on your Liebert Series 600 UPS, observe **ALL** of the **WARNINGS** in **4.0 - Maintenance**.

Use the Monitor/Mimic Display to determine the operating condition of the UPS module.

From the Master Menu, select the Shutdown Procedures screen. Note that this is a two-page screen.

Figure 56 Shutdown Procedures Screen

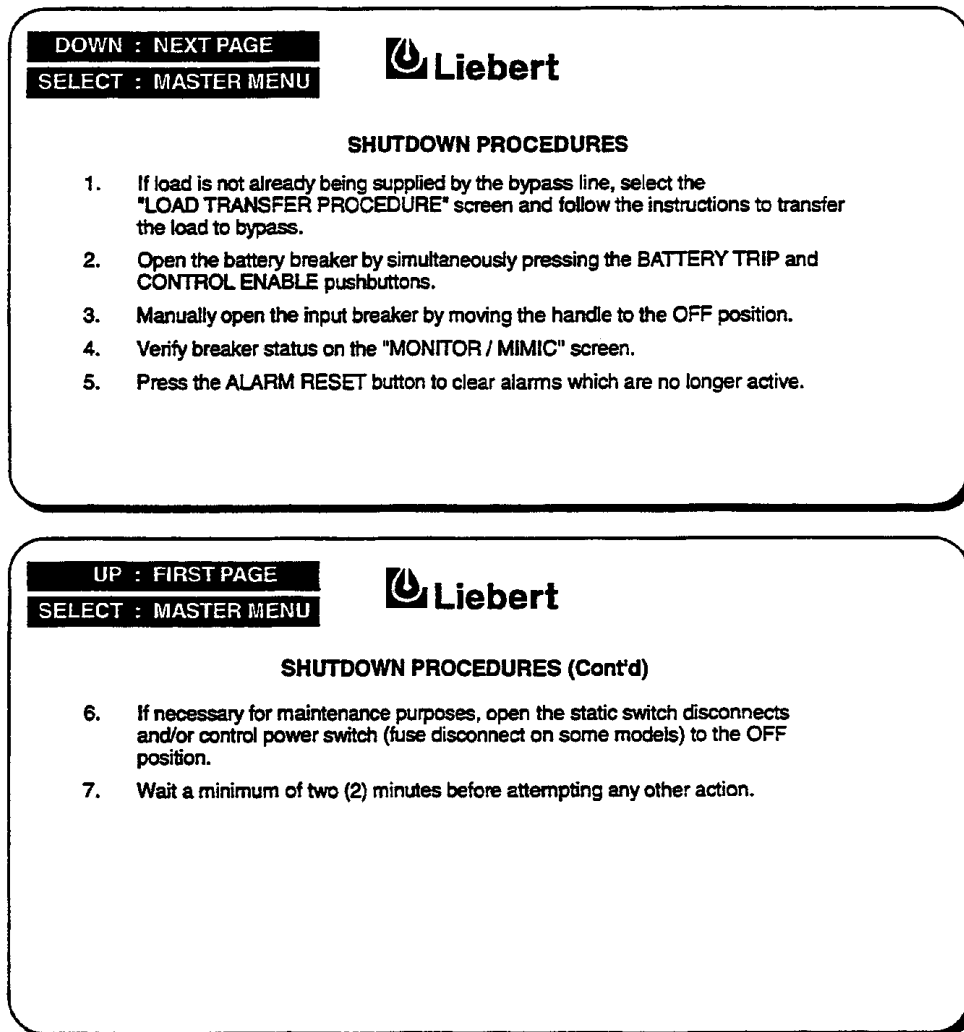

**Step 1.** If the UPS module is supplying power to the load (Load On UPS), select the Load Transfer Procedures screen and perform a manual transfer to the bypass line (Load On Bypass). This will open the UPS module output motorized circuit breaker (**Figure 7** and **Figure 8**).

**Step 2.** Open the module battery disconnect (MBD) circuit breaker by simultaneously pressing the **Battery Trip** and **Control Enable** pads (**Figure 10**).

**Step 3.** Manually open the UPS input circuit breaker by moving the handle to the OFF position (**Figure 7** and **Figure 8**).

Return to the Monitor/Mimic Display to verify status of the circuit breakers. Press the **Alarm Reset** pad to clear alarm messages.

---

**Step 4.** If maintenance is required on the Static Bypass Switch, turn the **Static Switch Disconnects** (Disconnect) to the OFF (open) position (**Figure 7** and **Figure 8**).



**CAUTION**

**The UPS bypass line is still energized.**

**Step 5.** If maintenance is required on the UPS controls, turn the **Control Power** switch to the OFF position (**Figure 7** and **Figure 8**). You may also want to open the Rectifier Input Breaker (RIB), external to the UPS cabinet.

At this point, power is removed from the UPS module components, but the bypass line is still energized and supplying power to the load.

**Step 6.** If maintenance is required in the area of the UPS motorized circuit breakers, transfer the load to the Maintenance Bypass, if available.

- a. Close the Maintenance Bypass Breaker (MBB).
- b. Open the Maintenance Isolation Breaker (MIB).
- c. Open the Bypass Input Breaker (BIB).



**CAUTION**

**If your installation does not include a Maintenance Bypass, power must still be isolated from both sides of the UPS circuit breakers if maintenance is required. This will result in loss of power to the critical load. Perform an orderly load shutdown before isolating power.**



**WARNING**

**LETHAL VOLTAGES ARE PRESENT WITHIN THIS UNIT EVEN WHEN IT IS NOT ON OR WHEN UTILITY IS NOT BEING SUPPLIED. OBSERVE ALL CAUTIONS AND WARNINGS IN THIS MANUAL. FAILURE TO DO SO COULD RESULT IN SERIOUS INJURY OR DEATH. DO NOT WORK ON OR OPERATE THIS EQUIPMENT UNLESS YOU ARE FULLY QUALIFIED TO DO SO!! NEVER WORK ALONE.**

Before performing any maintenance on your Liebert Series 600 UPS, observe **ALL** of the **WARNINGS** in **4.0 - Maintenance**.

---

### **Local Emergency Module Off (LEMO)**

The UPS controls include an **Emergency Module Off** pad (Figure 10, item 13). When this guarded pad is pressed, the **load is automatically transferred to the bypass line** and the input, output, and battery circuit breakers trip open to shut down and isolate the UPS module. Control Power for indicators and alarms remains on.

### **Remote Emergency Power Off (REPO)**

The Remote Emergency Power Off control (REPO) is a switch located **remotely** from the UPS module. It will normally be in the same room as the critical load equipment.

The Remote Emergency Power Off switch removes all power to the critical load.

When you trip the Remote Emergency Power Off switch, all UPS circuit breakers are opened, **including the bypass circuit breaker**. All power through the UPS is removed from the load. You will still have power to the UPS controls, and you may have power to the static switch.

## 3.4 Automatic Operations

The Liebert Series 600 UPS is designed to function while unattended by an operator. The system control logic monitors the performance of the UPS, the availability of power sources, and the current required by the critical load.

The system control logic

1. Determines what overload conditions can be sustained without a transfer to bypass.
2. Initiates an automatic transfer to bypass to sustain an overload, or when selected UPS faults occur.
3. Can initiate an automatic retransfer to the UPS after an overload has been cleared.
4. Initiates an automatic transfer to bypass and emergency module shutdown when selected UPS faults occur.

### 3.4.1 Overloads (Without Transfer)

The UPS inverter is capable of sustaining full output voltage ( $\pm 2\%$  of the nominal voltage) for overload conditions that remain within (under) the current versus time curve of overload capacity (**Figure 57**). Note that the time scale is not linear. Load On UPS is illustrated in **Figure 44**.

For high current demands of short duration (momentary overloads) the critical load is supplied simultaneously by both the UPS inverter and the bypass line. Refer to **3.2.3 - Momentary Overloads**.

Whenever an overload condition occurs, you should determine the cause of the overload.

If an overload condition exceeds the overload capacity, the UPS system initiates an automatic load transfer to the bypass line.

Figure 57 Current Versus Time Curve of Overload Capacity

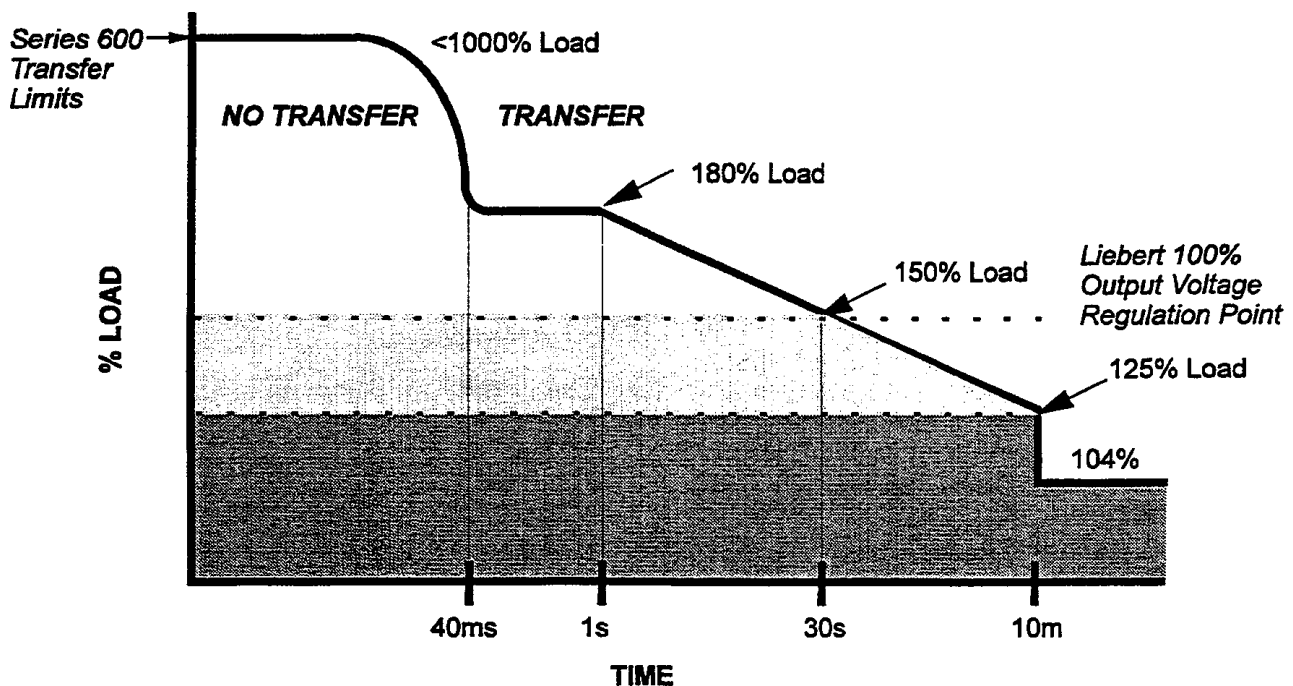

---

### 3.4.2 Automatic Transfers to Bypass

The UPS system will initiate an automatic load transfer to the bypass line if an overload condition exceeds the current versus time curve of overload capacity, or if specified UPS system faults occur. Load On Bypass is illustrated in **Figure 43**.

The Overload Transfer and Output Undervoltage alarm messages will initiate an automatic transfer to bypass and the Load On Bypass message will be displayed. The status report screens will include the Automatic Transfer to Bypass message. Other UPS system faults will initiate an automatic transfer to bypass followed immediately by a shutdown and isolation of the UPS system. Refer to **3.4.4 - Automatic Emergency Module Off**.

In an automatic transfer to bypass the output and bypass circuit breakers do not overlap as they do in a manual transfer. The static bypass switch is fired (closed), the output circuit breaker is opened, and the bypass circuit breaker is closed. Bypass power is supplied to the critical load through the static bypass switch during the short time while both circuit breakers are open.



#### NOTE

*A load transfer to the bypass line will be completed whenever an automatic transfer to bypass is initiated. If the Ok to Transfer condition is present, the load transfer will be uninterrupted. If the Static Switch Unable alarm message is present for any reason, the automatic transfer will be interrupted for 40 to 120 milliseconds. Because of the reliability of the UPS components, an interrupted load transfer is a very unlikely occurrence.*

### 3.4.3 Automatic Retransfers to UPS

Automatic Retransfer to UPS is an option that you can select from the System Configuration screen. If you do not want the UPS system to initiate any automatic retransfers, set Max Auto-Rexfer Attempts to zero (0).

In an automatic retransfer, the two motorized circuit breakers (bypass and inverter output) are both closed simultaneously for a short period of time (overlap).

The following critical bus conditions must be present to initiate an automatic retransfer of the critical load from the bypass source to the UPS inverter:

- a. The number of Auto-Rexfer Attempts selected must be greater than zero (0). If zero (0) is selected, no automatic retransfers will occur.
- b. Critical load was initially transferred to the bypass source due to an output overload only (a manual retransfer is required if the transfer to bypass was caused by any condition other than output overload).
- c. Overload has since dropped below 100% of the rated load.
- d. Both the Input or Battery (MBD) circuit breakers have remained closed since the overload transfer.
- e. OK to Transfer signal received from the control logic for at least 10 seconds, within 5 minutes of the overload transfer. (A manually initiated retransfer from bypass is required for overloads lasting 5 minutes or more.)
- f. Cyclic-type overloads, which occur up to five (select range is 0 to 5) times in 60 minutes, are automatically returned to the inverter for each event including the Nth overload. A manually initiated retransfer from bypass is required for the N+1 overload.

---

### 3.4.4 Automatic Emergency Module Off

For specified UPS system faults, the control logic will initiate an automatic transfer to bypass followed immediately by a shutdown and isolation of the UPS system. In the Emergency Module Off mode the input, battery (MBD), and output circuit breakers are open. The bypass breaker will be closed **if the bypass line is available**. Note that the bypass line is usually not available during Low Battery Shutdown. Emergency Module Off is illustrated in **Figure 48**.

The following UPS system faults will initiate an automatic Emergency Module Off:

- DC Over-Voltage Shutdown
- Hardware Shutdown
- Inverter Fuse Blown
- Low-Battery Shutdown
- Output Over-Voltage
- Overload Shutdown
- Over-Temperature Timeout
- Rectifier Fuse Blown
- Reverse Power

Refer to **Table 1** for more information regarding these alarm messages.



#### NOTE

*A load transfer to the bypass line will be completed whenever an automatic transfer to bypass is initiated and the bypass line is available. If the Static Switch Unable alarm message is present for any reason, the automatic transfer will be interrupted for 40 to 120 milliseconds. Because of the reliability of the UPS components, an interrupted load transfer is a very unlikely occurrence.*

Your installation may include an Emergency Power Off mode that can be initiated automatically by a contact closure in the critical load equipment. Refer to **3.2.7 - Remote Emergency Power Off (REPO)**.



---

## 4.0 MAINTENANCE

---

If you require assistance for any reason, call the toll-free Liebert Customer Service & Support number; 1-800-543-2378. For CS&S to assist you expediently, please have the following information available:

Part Number: \_\_\_\_\_  
Serial Number: \_\_\_\_\_  
kVA Rating: \_\_\_\_\_  
Date Purchased: \_\_\_\_\_  
Date Installed: \_\_\_\_\_  
Location: \_\_\_\_\_  
Input Voltage: \_\_\_\_\_  
Output Voltage: \_\_\_\_\_  
Battery Reserve Time: \_\_\_\_\_

### 4.1 Safety Precautions

Observe the safety precautions in **1.0 - Introduction**.

ONLY qualified service personnel should perform maintenance on the UPS system.

Observe ALL of the WARNINGS below before performing ANY maintenance on the UPS System and associated equipment. Also observe the manufacturer's safety precautions pertaining to the battery, along with the battery safety precautions in this section.



#### **CAUTION**

**Always identify connecting wiring prior to disconnecting any wiring.**

**Do not substitute parts except as authorized by Liebert Corporation.**

**Maintain the UPS cabinets free of foreign materials such as solder, wire cuttings, etc.**

**Call the Liebert Customer Service & Support if you are not sure of the procedures to follow or if you are not familiar with the circuitry.**



**WARNING**

**EXTREME CAUTION IS REQUIRED WHEN PERFORMING MAINTENANCE.**

**BE CONSTANTLY AWARE THAT THE UPS SYSTEM CONTAINS HIGH DC AS WELL AS AC VOLTAGES. WITH INPUT POWER OFF AND THE BATTERY DISCONNECTED, HIGH VOLTAGE AT FILTER CAPACITORS AND POWER CIRCUITS SHOULD BE DISCHARGED WITHIN 30 SECONDS. HOWEVER, IF A POWER CIRCUIT FAILURE HAS OCCURRED, YOU SHOULD ASSUME THAT HIGH VOLTAGE MAY STILL EXIST AFTER SHUTDOWN CHECK WITH A VOLTMETER BEFORE MAKING CONTACT.**

**AC VOLTAGE WILL REMAIN ON THE BYPASS AND OUTPUT CIRCUIT BREAKERS, AND THE STATIC BYPASS SWITCH, UNLESS ASSOCIATED EXTERNAL CIRCUIT BREAKERS ARE OPENED.**

**CHECK FOR VOLTAGE WITH BOTH AC AND DC VOLTMETERS PRIOR TO MAKING CONTACT.**

**WHEN THE UPS SYSTEM IS UNDER POWER, BOTH THE OPERATOR AND ANY TEST EQUIPMENT MUST BE ISOLATED FROM DIRECT CONTACT WITH EARTH GROUND AND THE UPS CHASSIS FRAME BY USING RUBBER MATS.**

**SOME COMPONENTS WITHIN THE CABINETS ARE NOT CONNECTED TO CHASSIS GROUND.**

**ANY CONTACT BETWEEN FLOATING CIRCUITS AND THE CHASSIS IS A LETHAL SHOCK HAZARD. - USE DIFFERENTIAL OSCILLOSCOPES WHEN MEASURING A FLOATING CIRCUIT. THE DIFFERENTIAL INPUT SHOULD HAVE AT LEAST 800 V<sub>rms</sub> COMMON MODE INPUT RATING AND A COMMON MODE REJECTION RATIO OF AT LEAST 80 dB.**

**EXERCISE CAUTION THAT THE TEST INSTRUMENT EXTERIOR DOES NOT MAKE CONTACT EITHER PHYSICALLY OR ELECTRICALLY WITH EARTH GROUND.**

**IN CASE OF FIRE INVOLVING ELECTRICAL EQUIPMENT, USE ONLY CARBON DIOXIDE FIRE EXTINGUISHERS, OR OTHERS APPROVED FOR USE IN ELECTRICAL FIRE FIGHTING.**

---

## 4.2 Liebert Customer Service and Support

Start-up, UPS maintenance, battery maintenance, and training programs are available for the Series 600 UPS through your Liebert sales representative.

### Professional Start-Up

**UPS Start-Up** - Liebert's Customer Engineers perform a thorough non-powered inspection of the units, and will then conduct a complete electrical checkout which includes calibrating all components to published specifications. The battery installation is also inspected and placed on an initialization charge to ensure cell equalization. Customer - Operation training will be conducted during battery charge time.

Load Bank Testing and Full Site Acceptance Testing are additional services that can be performed during a UPS Start-Up. One Preventive Maintenance Service Call can be added to the initial UPS Start-Up Agreement.

**Battery Installation/Start-Up** - When purchased with a UPS Start-Up, this Agreement provides consistent, professional service for your entire UPS system. This one-source approach avoids conflicts that may occur during a multisource installation. Note that Liebert requires a **mandatory** installation inspection for all batteries not installed by Liebert Customer Engineers.

**Battery IEEE Certification Inspection** - The Battery Specialist will perform a detailed inspection of the entire battery system to ensure it meets current IEEE standards.

### Maintenance Agreements

**UPS Standard Full Service Agreement** - This Agreement offers a total service package for UPS systems. This includes two scheduled Preventive Maintenance (P.M.) Service Calls per year. It also covers all Remedial and Corrective Maintenance visits, consisting of the diagnosis and correction of product malfunctions and repairs, and parts. Customer Engineers will be available to the Customer 24 hours a day, 7 days a week.

This agreement also includes one Infra-Red Scanning visit. A full Thermographic Survey is offered as an additional service.

**UPS Preventive Maintenance Service** - One Preventive Maintenance (P.M.) Service Call will be scheduled and performed at the customer's convenience. During a P.M. visit, the Customer Engineer will conduct a thorough non-powered inspection. Then, the powered inspection will include a complete electrical checkout and calibration of all components to specifications.

**Battery Basic Service Agreement** - This Agreement provides two (for sealed cells) or four (for flooded cells) visits per year. During these visits, the entire battery system will be inspected and checked against factory specifications. The Battery Specialist will clean, add water, adjust voltages, and tighten connections as needed. A report of all recordings taken during each visit (voltages, specific gravity, etc.) will be prepared for the Customer. Any recommendations for corrective action, such as cell replacements, will be noted.

**Battery Standard Full Service Agreement** - This Agreement includes four P.M. visits per year and corrective maintenance.

**Extended Full Service Agreements** - For the UPS system and for the battery, these Agreements provide the Customer the convenience of scheduling P.M. visits during evenings and weekends. The Battery Extended Full Service Agreement provides four (for sealed cells) or twelve (for flooded cells) P.M. visits per year, corrective maintenance, and parts.

### Training

Customer training courses include the proper operation of the system, emergency procedures, preventive maintenance and some corrective maintenance.

### Warranties

Contact Customer Service and Support if you have any questions regarding the warranty on your Series 600 UPS or the batteries.

---

## 4.3 Routine Maintenance

You are encouraged to become thoroughly familiar with the equipment, but at no time should you go beyond the specific procedures in this manual while performing maintenance or correcting a malfunction. If you have any doubt as to what must be done, call Liebert Customer Service & Support at 1-800-543-2378 for further instructions.

The UPS is designed for unattended operation, but does require some common sense maintenance.

- Keep good records.

Troubleshooting is easier if you have historical background.

- Keep it clean.

Maintain the UPS free of dust and any moisture.

- Keep it cool.

Although the UPS will operate within specifications at higher temperatures, performance will be further enhanced when the UPS is operated at 25°C.

- Keep connections tight.

Tighten all connections at installation and at least annually thereafter. (See Torque Requirements, **Table 4**.)

### 4.3.1 Record Log

Set up a maintenance log to record scheduled checks and any abnormal conditions.

The log should have space for all metered parameter indications including phase readings, alarm messages, UPS mode of operation, air filter replacement date, and observation notes. A second log should be maintained for the battery module as directed by the battery manufacturer.

A periodic walk-through inspection of the UPS and battery rooms is advised to check for visible and audible indications of problems. Log the inspection, metered parameter indications, and any discrepancies.

### 4.3.2 Air Filters

A schedule for inspection of the air filters is required. The period between inspections will depend upon environmental conditions. Under normal conditions, the air filters will require service or replacement approximately every two months.

Abnormal or dusty conditions will require more frequent cleaning and/or replacement of air filters. Inspect installations in new buildings more often, then extend the inspection period as experience dictates.

---

### 4.3.3 Battery Maintenance



#### **WARNING**

**THESE MAINTENANCE PROCEDURES WILL EXPOSE HAZARDOUS LIVE PARTS. REFER SERVICING TO QUALIFIED PERSONNEL.**

**DC FUSES OPERATE AT THE RATED BATTERY VOLTAGE AT ALL TIMES. A BLOWN DC BUS FUSE INDICATES A SERIOUS PROBLEM. SERIOUS INJURY OR DAMAGE TO THE EQUIPMENT CAN RESULT IF THE FUSE IS REPLACED WITHOUT KNOWING WHY IT FAILED. CALL LIEBERT CUSTOMER SERVICE AND SUPPORT FOR ASSISTANCE.**

#### **Battery Safety Precautions**

Servicing of batteries should be performed or supervised by personnel knowledgeable of batteries and the required precautions. Keep unauthorized personnel away from batteries.

When replacing batteries, use the same number and type of batteries.



#### **CAUTION**

**Lead-acid batteries contain hazardous materials. Batteries must be handled, transported, and recycled or discarded in accordance with federal, state, and local regulations. Because lead is a toxic substance, lead-acid batteries should be recycled rather than discarded.**

**Do not dispose of battery or batteries in a fire. The battery may explode.**

**Do not open or mutilate the battery or batteries. Released electrolyte is harmful to the skin and eyes. It may be toxic.**

**A battery can present a risk of electrical shock and high short circuit current. The following precautions should be observed when working on batteries:**

- 1. Remove watches, rings, or other metal objects.**
- 2. Use tools with insulated handles.**
- 3. Wear rubber gloves and boots.**
- 4. Do not lay tools or metal parts on top of batteries.**
- 5. Disconnect charging source prior to connecting or disconnecting battery terminals.**
- 6. Determine if battery is inadvertently grounded. If inadvertently grounded, remove source of ground. Contact with any part of a grounded battery can result in electrical shock. The likelihood of such shock will be reduced if such grounds are removed during installation and maintenance.**

**Lead-acid batteries can present a risk of fire because they generate hydrogen gas. The following procedures should be followed:**

- 1. DO NOT SMOKE when near batteries.**
- 2. DO NOT cause flame or spark in battery area**
- 3. Discharge static electricity from body before touching batteries by first touching a grounded metal surface.**

---

## Battery Safety Precautions In French Per CSA Requirements

### Instructions Importantes Concernant La Sécurité

#### Conserver Ces Instructions



#### ADVERTISSEMENT

DES PIÈCES SOUS ALIMENTATION SERONT LAISSÉES SANS PROTECTION DURANT CES PROCÉDURES D'ENTRETIEN. UN PERSONNEL QUALIFIÉ EST REQUIS POUR EFFECTUER CES TRAVAUX.

LES FUSIBLES A C.C. DE LA BATTERIE D'ACCUMULATEURS OPÈRENT EN TOUT TEMPS A LA TENSION NOMINALE. LA PRÉSENCE D'UN FUSIBLE A C.C. BRÛLÉ INDIQUE UN PROBLÈME SÉRIEUX. LE REMPLACEMENT DE CE FUSIBLE, SANS AVOIR DÉTERMINÉ LES RAISONS DE LA DÉFECTUOSITÉ, PEUT ENTRAÎNER DES BLESSURES OU DES DOMMAGES SÉRIEUX À L'ÉQUIPEMENT. POUR ASSISTANCE, APPELER LE DÉPARTEMENT DE SERVICE À LA CLIENTÈLE DE LIEBERT.



#### DANGER

Les accumulateurs plomb-acide contiennent de la matière comportant un certain risque. Les accumulateurs doivent être manipulés, transportés et recyclés ou éliminés en accord avec les lois fédérales, provinciales et locales. Parce que le plomb est une substance toxique, les accumulateurs plomb-acide devraient être recyclés plutôt qu'éliminés.

Il ne faut pas brûler le ou les accumulateurs. L'accumulateur pourrait alors exploser.

Il ne faut pas ouvrir ou endommager le ou les accumulateurs. L'électrolyte qui pourrait s'en échapper est dommageable pour la peau et les yeux.

Un accumulateur représente un risque de choc électrique et de haut courant de court-circuit. Lorsque des accumulateurs sont manipulés, les mesures préventives suivantes devraient être observées:

1. Retirer toutes montres, bagues ou autres objets métalliques.
2. Utiliser des outils avec manchon isolé.
3. Porter des gants et des bottes de caoutchouc.
4. Ne pas déposer les outils ou les pièces métalliques sur le dessus des accumulateurs.
5. Interrompre la source de charge avant de raccorder ou de débrancher les bornes de la batterie d'accumulateurs.
6. Déterminer si l'accumulateur est mis à la terre par erreur. Si oui, défaire cette mise à la terre. Tout contact avec un accumulateur mis à la terre peut se traduire en un choc électrique. La possibilité de telles chocs sera réduite si de telles mises à la terre sont débranchées pour la durée de l'installation ou de l'entretien.

---

Les accumulateurs plomb-acide présentent un risque d'incendie parce qu'ils génèrent des gaz à l'hydrogène. Les procédures suivantes devront être respectées.

1. **NE PAS FUMER** lorsque près des accumulateurs.
2. **NE PAS** produire de flammes ou d'étincelles près des accumulateurs.
3. Décharger toute électricité statique présente sur votre corps avant de toucher un accumulateur en touchant d'abord une surface métallique mise à la terre.



**DANGER**

L'électrolyte est un acide sulfurique dilué qui est dangereux au contact de la peau et des yeux. Ce produit est corrosif et aussi conducteur électrique. Les procédures suivantes devront être observées:

1. Porter toujours des vêtements protecteurs ainsi que des lunettes de protection pour les yeux.
2. Si l'électrolyte entre en contact avec la peau, nettoyer immédiatement en rinçant avec de l'eau.
3. Si l'électrolyte entre en contact avec les yeux, arroser immédiatement et généreusement avec de l'eau. Demander pour de l'aide médicale.
4. Lorsque l'électrolyte est renversée, la surface affectée devrait être nettoyée en utilisant un agent neutralisant adéquat. Une pratique courante est d'utiliser un mélange d'approximativement une livre (500 grammes) de bicarbonate de soude dans approximativement un gallon (4 litres) d'eau. Le mélange de bicarbonate de soude devra être ajouté jusqu'à ce qu'il n'y ait plus apparence de réaction (mousse). Le liquide résiduel devra être nettoyé à l'eau et la surface concernée devra être asséchée.

Regular maintenance of the battery module is an absolute necessity. Periodic inspections of battery and terminal voltages, specific gravity, and connection resistance should be made. Strictly follow the procedures outlined in the battery manufacturer's manual.

Sealed-cell (maintenance-free) batteries do require periodic maintenance. Though they do not require maintenance of electrolyte levels, battery voltage and connection resistance checks should be made.



**NOTE**

*Do not use cleaners on the batteries. Solvents can make the battery cases brittle. Use only a dry cloth or a cloth moistened with water.*

Since individual battery characteristics are not identical, and may change over time, the UPS module is equipped with circuitry to equalize battery cell voltages. This circuit increases charging voltage to maintain flooded type battery cells at full capacity.



**NOTE**

*Do not use equalize charging with sealed-cell batteries.*

*Consult the battery manufacturer's manual for specific information about equalize charging.*

The equalizing charge time period is adjustable from zero to 72 hours and can be initiated automatically or manually. Refer to **3.0 - Operation**.

Battery Voltage Record			
Date	Float Voltage (Volts DC)	Nominal Voltage (Volts DC)	Ambient Temp. (°F)
* _____	* _____	* _____	* _____
_____	_____	_____	_____
_____	_____	_____	_____
_____	_____	_____	_____
_____	_____	_____	_____
_____	_____	_____	_____
_____	_____	_____	_____
_____	_____	_____	_____
_____	_____	_____	_____
_____	_____	_____	_____
_____	_____	_____	_____
_____	_____	_____	_____
_____	_____	_____	_____
_____	_____	_____	_____
_____	_____	_____	_____

\* To be completed by Liebert Customer Service Representative at time of start-up.



---

## Matching Battery Cabinets (Optional for 150 and 225 kVA)

Although the individual battery cells are sealed (valve-regulated) and require only minimal maintenance, the Battery Cabinets should be given a periodic inspection and electrical check. Checks should be performed at least annually to ensure years of trouble-free service.

**Voltage Records.** With the Battery Cabinet DC circuit breaker closed and the connected UPS operating, measure and record battery float voltage. With the DC circuit breaker open, measure and record the nominal (open circuit) voltage. Both these measurements should be made across the final positive and negative terminal lugs. Compare these values with those shown below. The recorded nominal voltage should be no less than the value shown, while the recorded float voltage should be within the range shown. If a discrepancy is found, contact Liebert Customer Service and Support.

Number of Cells	Battery Voltage (VDC)	
	Nominal	Float
240	480	527 - 576

**Power Connections.** Check for corrosion and connection integrity. Visually inspect wiring for discolored or cracked insulation. Clean and/or retighten as required. Refer to Torque Specifications, **Table 4**.

**Battery Cell Terminals.** Check for discoloration, corrosion, and connection integrity. Clean and tighten if necessary. Note that when installing a new battery, the initial torque value is 5 lb.-in more than the retorque value. Retorque values are:

Battery Manufacturer	Battery Model Number	Retorque Value
<b>Johnson Controls Batteries</b>	UPS12-270(FR)	32 lb-in.
	UPS12-310(FR)	52 lb-in.
	UPS12-370(FR)	52 lb-in.
	UPS12-475(FR)	110 lb-in.
<b>C&amp;D Batteries</b>	LS12-100	100 lb-in.
	12G-17	100 lb-in.
<b>Power Batteries</b>	PRC12110X	65 lb-in.
	PRC12120X	65 lb-in.
	PRC12150X	85 lb-in.
	PRC1290X	65 lb-in.
	TC12110X	65 lb-in.
	TC12120X	65 lb-in.
	TC12150X	85 lb-in.
	TC1290X	65 lb-in.

If you have a different model battery, contact Liebert Customer Service and Support for the required torque value.

**To access battery cell terminals,** disconnect the inter-tier cable and two shelf retaining screws. Once disconnected, insulate (with protective boot or electrical tape) the cables to prevent accidental shorts. The battery shelf can now be pulled out. Tighten each terminal connection to the retorque value. When replacing a battery, the terminal connections must be cleaned and tightened. Disconnect and insulate the cables connected to the battery. Secure each battery shelf with retaining screws when maintenance is complete.

### Rack-Mounted Batteries

If the UPS system uses a battery other than a factory supplied Matching Battery Cabinet, perform maintenance on the battery as recommended in the battery manufacturer's maintenance manual.

### 4.3.4 Torque Requirements

All electrical connections must be tight. **Table 4** provides the torque values for the connections in the UPS. Use the values in **Table 4** unless the equipment is labeled with a different torque value.



**NOTE**

*Refer to battery manufacturer's manual for the proper torque values required for the battery.*

**Table 4 Torque Specifications**

Nut and Bolt Combinations				
Bolt Shaft Size	Grade 2 Standard		Electrical Connections with Belleville Washers	
	Lb-in	N-m	Lb-in	N-m
1/4	53	6.0	46	5.2
5/16	107	12	60	6.8
3/8	192	22	95	11
1/2	428	48	256	29

Circuit Breakers With Compression Lugs (For Power Wiring)			Terminal Block Compression Lugs (For Control Wiring)		
Current Rating	Lb-in	N-m	AWG Wire Size or Range	Lb-in	N-m
400 - 1200 Amps	300	34	#22 - #14	3.5 to 5.3	0.4 to 0.6

### 4.4 Detection of Trouble

There is no practical way to anticipate an impending malfunction. It is important that the operator check the instrument readings if abnormal equipment performance is suspected.

Items to check include:

1. Output voltage of all phases should be within 2% of normal voltage. Output currents on each phase should not normally differ by more than 20%. If a greater difference is noted, the load is unbalanced and corrective action should be taken to redistribute the load, if possible.
2. If the UPS has not operated on battery power during the last 10 hours, the batteries should require little charging current. Battery mimic should indicate normal DC voltage with the battery charge current no more than 31 Amperes.
3. Input current on each phase should be within 10% of the average input current.
4. Any metered parameter indication that deviates appreciably from normal could mean an impending malfunction, which may require troubleshooting.
5. Alarm messages indicate malfunction or impending malfunction. A daily check of the Operator Control Panel will help to provide an early detection of problems. Refer to **Table 1** and **Table 2** in **3.0 - Operation** to interpret alarm messages.
6. Tracing a problem to a particular section is facilitated by alarm messages and the metered parameter indications. These are stored in the Status Reports and can be displayed at the Operator Control Panel or at an optional terminal. The Liebert Customer Service Engineer will also be familiar with test points inside the unit.



**NOTE**

*If the UPS system has a blown fuse, the cause should be determined before you replace the fuse. Contact Liebert Customer Service and Support.*

---

## 4.5 Reporting a Problem

If a problem occurs within the UPS, review all alarm messages along with other pertinent data. This information should be given via telephone to the Liebert Field Service Regional Office nearest you. This information can also be automatically sent by telephone modem. Call 1-800-543-2378 or your nearest Liebert CS&S office to report a problem or to request assistance.

## 4.6 Corrective Actions

For each alarm message on the Operator Control Panel and the Remote Monitor Panel, you can find the recommended corrective action in **Table 1 of 3.0 - Operation**.

## 4.7 Recommended Test Equipment

A list of recommended test equipment and tools required to maintain, troubleshoot, and repair the UPS module is given in **Table 5**. You may substitute instruments of equivalent range and accuracy. All instruments should be calibrated and be within the current calibration cycle. Calibration data for the instruments should be maintained in historic files and the instruments labeled for audit and verification.

**Table 5 Recommended Test Equipment and Tools**

Quantity	Test Equipment	Manufacturer	Model or Type
1	Oscilloscope	Tektronix or H-P	DC to 10 MHz, Vertical Plug-In Amp
2	Vertical Plug-In Amp	Tektronix or H-P	DC Coupled, Differential and/or Dual Trace
2	Voltage Probes	Tektronix or H-P	10X, with 10 ft Cable
2	Voltage Probes	Tektronix or H-P	100X, with 10 ft Cable
1	Multi-Meter	Simpson	260, with Test Leads
1	Digital Multi-Meter	Fluke	8030, with Test Leads
1	Tool Kit	Liebert Corporation	—

---

## 5.0 SPECIFICATIONS AND RATINGS

---

### 5.1 Rating

The kVA and kW ratings and the nominal voltages and currents for continuous operation are listed on the unit nameplates (inside Operator Control Panel door) and on the System One-Line Diagram. The rated output power envelope of the UPS is illustrated in **Figure 58**. The UPS is rated to deliver rated kVA and rated kW at 0.8 lagging power factor (pf), or 0.9 lagging pf for some models. However, the UPS will operate connected loads with power factors ranging from 0.7 lagging through 1.0 (unity).

Connected load kW and kVA are both displayed on the LCD screen when the UPS is powering the load. Power factor may be easily calculated by  $kW \div kVA = pf$ .

For load power factors between 0.8 lagging and 1.0, the full kVA rating of the unit is available. However, above the rated pf the kW rating will become the limiting factor. Note that some models are specifically rated for a 0.9 lagging output power factor.

For loads with power factors below 0.7 lagging or with leading power factors, the UPS output is kVA limited and the UPS System may not meet all of its output performance specifications. Consult your Liebert sales representative for performance specifications for these applications.

**Figure 58 Output Power Envelope for 0.8 pf Rated Units**

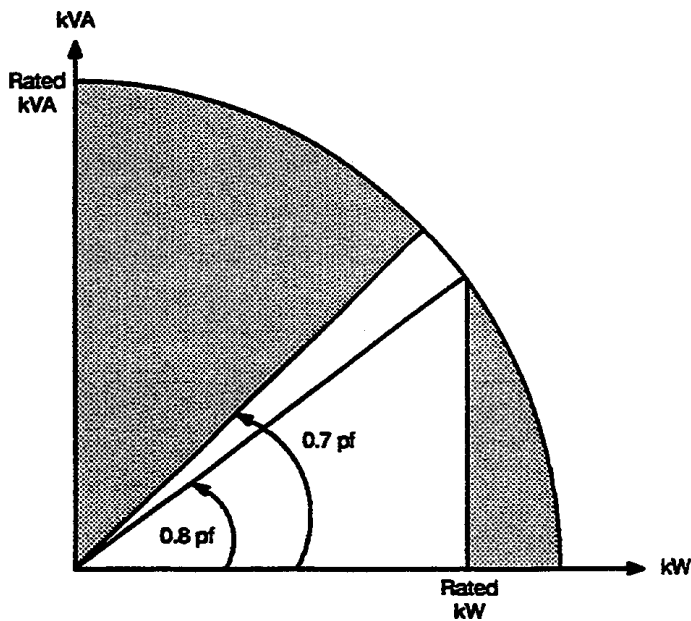

## 5.2 Environmental Conditions

<b>Enclosure:</b>	The UPS is housed in a NEMA-1 enclosure. The enclosure is designed for indoor use only and is not to be subjected to falling objects or precipitation.
<b>Recommended Operating Temperature:</b>	25°C
<b>Maximum Operating Temperature:</b>	40°C (design temperature) without aerating
<b>Minimum Operating Temperature:</b>	0°C
<b>Storage Temperature:</b>	-20°C to 70°C
<b>Typical Battery Temperature Requirements:</b>	Average annual temperature shall not exceed 27°C. Peak temperature shall not exceed 43°C during any 24-hour period. See battery manufacturer's recommendations.
<b>Relative Humidity:</b>	0 to 95% without condensation
<b>Operating Elevation:</b>	Sea level to 1219 meters (4000 ft.) without derating
<b>Storage Elevation:</b>	Sea level to 12,192 meters (40,000 ft.)
<b>Audible Noise:</b>	75 dBA typical, measured 5 feet from unit (69 dBA typical for 150-375 kVA units)
<b>Derating for Higher Ambient Temperatures:</b>	91% at 45°C
	82% at 50°C
	73% at 55°C
	Consult your Liebert sales representative regarding applications in high ambient temperatures. Special temperature sensors must be installed at the factory.
<b>Derating for Higher Elevations:</b>	95% at 2000 meters
	94% at 2200 meters
	93% at 2400 meters
	92% at 2600 meters
	91% at 2800 meters
	90% at 3000 meters



### NOTE

*This category of electronic equipment is agency rated for use in an atmosphere free of conductive particles. Some industrial facilities may require a room air filtration system to keep the UPS free of excess moisture and contaminants.*

*The UPS system is designed to operate continuously at 40°C. However, equipment design life expectancy will be extended with lower temperatures; 25°C is considered optimal.*

---

## 5.3 Adjustments

All adjustments are set at the factory or during start-up and normally do not have to be field readjusted.

- Input Current Limit: Normal, 115%; on generator, 100%.
- Battery Charge Current Limit: Normal, 10%; on generator, 1%.
- Battery Equalize Charge: Set at start-up dependent on battery characteristics.
- DC Over-Voltage: 445 volts for models with nominal 180 cell battery (Low Link) [600 volts for model with nominal 240 cell battery (High Link)].
- Overload Alarm: 104% normal load.
- Output Frequency Tolerance:  $\pm 0.5$  Hz.
- Output Voltage: Nominal—operator adjustable  $\pm 5\%$ .
- Line Drop Compensation: 0 to +5%—Set at start-up to match load characteristics. If significant additional loads are connected, call Liebert Customer Service and Support.

## 5.4 Battery Operation

The separate battery manufacturer's manual provides the necessary information for the installation, operation, and maintenance of the battery. Use the battery manual in conjunction with this manual.

The float charge voltage for a battery is equal to the number of cells in series making up the battery multiplied by the charge voltage for each cell.

Since the charging voltage level is critical to proper battery operation, refer to your battery manual for information regarding your system.

For models with nominal 180 cell battery (Low Link), the DC bus voltage range is 387 to 423 VDC. Battery voltage at end of discharge is 287 VDC at the UPS terminals (290 VDC at the battery). The number of battery cells required will range from 172 to 182, depending on your application.

For models with nominal 240 cell battery (High Link), the DC bus nominal voltage range is 527 to 576 VDC. Maximum equalize voltage is 585 VDC. Battery voltage at end of discharge is 384 VDC at the UPS terminals (387 VDC at the battery). The number of battery cells required will range from 232 to 244, depending on your application.

## 5.5 Electrical Specifications

<b>RECTIFIER INPUT</b>	
<b>Input Voltage:</b>	Standard voltages—208 VAC, 480 VAC, 600 VAC. Other voltages available on request. 3-phase, 3-wire plus ground.
<b>Voltage Range:</b>	+10%, -15% (no battery discharge at -20%).
<b>Frequency Range:</b>	57 Hz to 63 Hz.
<b>Subcycle Magnetization Inrush:</b>	150 kVA to 375 kVA with optional input isolation transformer and 338 kVA through 1000 kVA. Up to 6 times normal full load input current. Up to 4 times normal full load input current with optional input filter.
<b>Input Current Walk-In:</b>	From 20% to 100% in 15 seconds.
<b>Current Limit:</b>	Maximum of 125% normal full load input current.
<b>Current Distortion</b>	150 kVA to 375 kVA. Less than 30% THD (reflected) typical at normal full load input current. Less than 7% THD (reflected) typical at normal full load input current with optional input filter.
	338 kVA to 1000 kVA (SCR-based). Less than 9% THD (reflected) typical at normal full load input current. Less than 4% THD (reflected) typical at normal full load input current with optional input filter.
<b>Power Factor</b>	0.85 minimum lagging at full load. 0.92 minimum lagging at full load with optional input filter.
<b>BYPASS INPUT</b>	
<b>Input Voltage:</b>	Standard voltages—208Y/120 VAC, 480Y/277 VAC, 600Y/346 VAC. Other voltages available on request. 3-phase, 4-wire plus ground preferred; 3-phase, 3-wire plus ground also available.
	Optional voltages—208 VAC, 480 VAC, 600 VAC. Other optional voltages available on request. 3-phase, 3-wire plus ground (ungrounded or corner-grounded delta).
<b>Voltage Range:</b>	±5% for manually initiated bypass transfer. ±10% for automatically initiated uninterrupted transfer.
<b>Frequency Range:</b>	59.5 Hz to 60.5 Hz.
<b>Voltage Transient:</b>	±4% for manually initiated bypass transfer.

<b>CRITICAL LOAD OUTPUT</b>	
<b>Output Voltage:</b>	Standard voltages—208Y/120 VAC, 480Y/277 VAC, 600Y/346 VAC. Other voltages available on request. 3-phase, 4-wire plus ground preferred; 3-phase, 3-wire plus ground available.
	Optional voltages—208 VAC, 480 VAC, 600 VAC. Other optional voltages available on request. 3-phase, 3-wire plus ground (ungrounded or corner grounded delta).
<b>Voltage Regulation:</b>	±0.5% for balanced load. ±2% for unbalanced load.
<b>Voltage Adjustment Range:</b>	±5% manually.
<b>Line Drop Compensation Range:</b>	Up to +5% automatic load dependent.
<b>Frequency</b>	59.5 Hz to 60.5 Hz.
<b>Slew Rate:</b>	0.06 Hz per second (adjustable 0.01 to 0.1).
<b>Phase Balancing:</b>	120° ±1° for balanced loads. 120° ±3° for 50% unbalanced loads.
<b>Voltage Imbalance:</b>  20% Unbalanced Load 50% Unbalanced Load	±1% from the arithmetic average of the 3 phases. ±2% from the arithmetic average of the 3 phases.
<b>Voltage Transient:</b>  20% Load Step 50% Load Step 100% Load Step Loss or Return of AC Input Power Manual Transfer of 100% Load	±4% from the average peak voltage. ±5% from the average peak voltage. ±7% from the average peak voltage. ±1% from the average peak voltage. ±4% from the average peak voltage.
<b>Voltage Transient Recovery Time:</b>	To within 1% of steady state output voltage within 50 milliseconds.
<b>Voltage Harmonic Content</b>	Maximum 5% RMS total, for any combination of linear and nonlinear loads. Maximum 3% RMS single, for linear loads.
<b>Overload at Full Output Voltage:</b>	104% of full load rating continuously. 125% of full load rating for 10 minutes. 150% of full load rating for 30 seconds. (with ±2% voltage regulation).
<b>Fault Clearing</b>	300% of normal full load current subcycle. 1000% of normal full load current up to 40 milliseconds with bypass available.





## **Series 600 & 600T™ UPS**

**Single-Module Three Phase**

**150 kVA to 1000 kVA; 60 Hz**

### **Technical Support**

U.S.A. 1-800-222-5877  
Outside the U.S.A. 614-841-6755  
U.K. +44 (0) 1793 553355  
France +33 1 4 87 51 52  
Germany +49 89 99 19 220  
Italy +39 2 98250 1  
Netherlands +00 31 475 503333  
E-mail [upstech@liebert.com](mailto:upstech@liebert.com)  
Web site <http://www.liebert.com>  
Worldwide FAX 614-841-5471  
tech support

### **The Company Behind The Products**

With more than 500,000 installations around the globe, Liebert is the world leader in computer protection systems. Since its founding in 1965, Liebert has developed a complete range of support and protection systems for sensitive electronics:

- Environmental systems: close-control air conditioning from 1.5 to 60 tons.
- Power conditioning and UPS with power ranges from 250 VA to more than 1000 kVA.
- Integrated systems that provide both environmental and power protection in a single, flexible package.
- Monitoring and control — on-site or remote — from systems of any size or location

Service and support, through more than 100 service centers around the world, and a 24-hour Customer Response Center.

While every precaution has been taken to ensure accuracy and completeness of this literature, Liebert Corporation assumes no responsibility, and disclaims all liability for damages resulting from use of this information or for any errors or omissions.

© 1998 Liebert Corporation. All rights reserved throughout the world. Specifications subject to change without notice.

® Liebert and the Liebert logo are registered trademarks of Liebert Corporation. All names referred to are trademarks or registered trademarks of their respective owners.

Printed in U.S.A.

SL-30021